

DYNAmore Express Webinar Series

Simulating Thermal-Mechanical Coupled Processes with LS-DYNA

- New Coupling Schemes, Boundary Conditions, Contact Algorithms and Materials -

Dr.-Ing. Thomas Klöppel
DYNAmore GmbH, Stuttgart, Germany

April 9, 2020



Motivation – Assembly Simulation

- State of the art digital process chain contains
 - (Hot) forming and press hardening simulations
 - Clamping simulations
 - Mechanical assembly steps, i.e. clinching, roller hemming, ...
 - Thermal assembly steps, i.e. resistance spot welds, laser welds, line weld (MIG, MAG), ...
 - Springback analysis
- Closed virtual process chain within LS-DYNA by data transfer from one stage to the next
 - Assembly of whole side-panel of a car
 - Hundreds of spot-welds, dozens of parts and multiple level of assemblies
- Tailored simulation strategies for each of the individual steps
 - As efficient as possible for each process, but without neglecting the critical effects
 - Keep track of material properties that might change significantly during process (e.g. phase evolution)

Content

- Boundary Conditions I
- Coupling Strategies
- Boundary Conditions II
- Material Modelling
- Thermal Contact Algorithms

Content

- Boundary Conditions I
 - *BOUNDARY_THERMAL_WELD_TRAJECTORY
 - *BOUNDARY_FLUX_TRAJECTORY
 - *BOUNDARY_TEMPERATURE_RSW

- Coupling Strategies

- Boundary Conditions II

- Material Modelling

- Thermal Contact Algorithms

Modelling line welding processes

- `*BOUNDARY_THERMAL_WELD_TRAJECTORY`
 - defines a volumetric heat source
 - motion along a trajectory (nodal path)
 - prescribed velocity, possibly as function of time
 - user can choose from a list of equiv. heat sources
- Works in thermal-only and coupled analyses

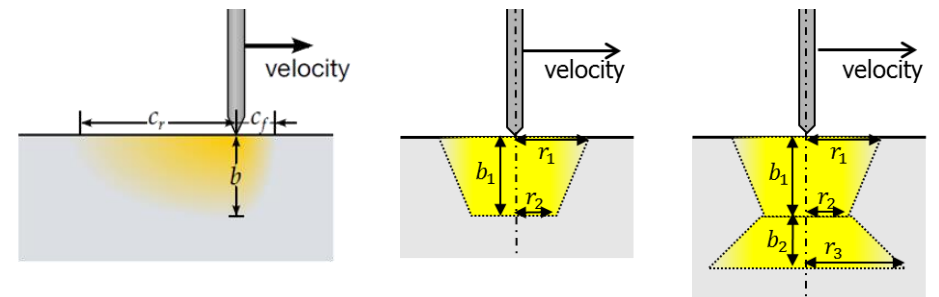
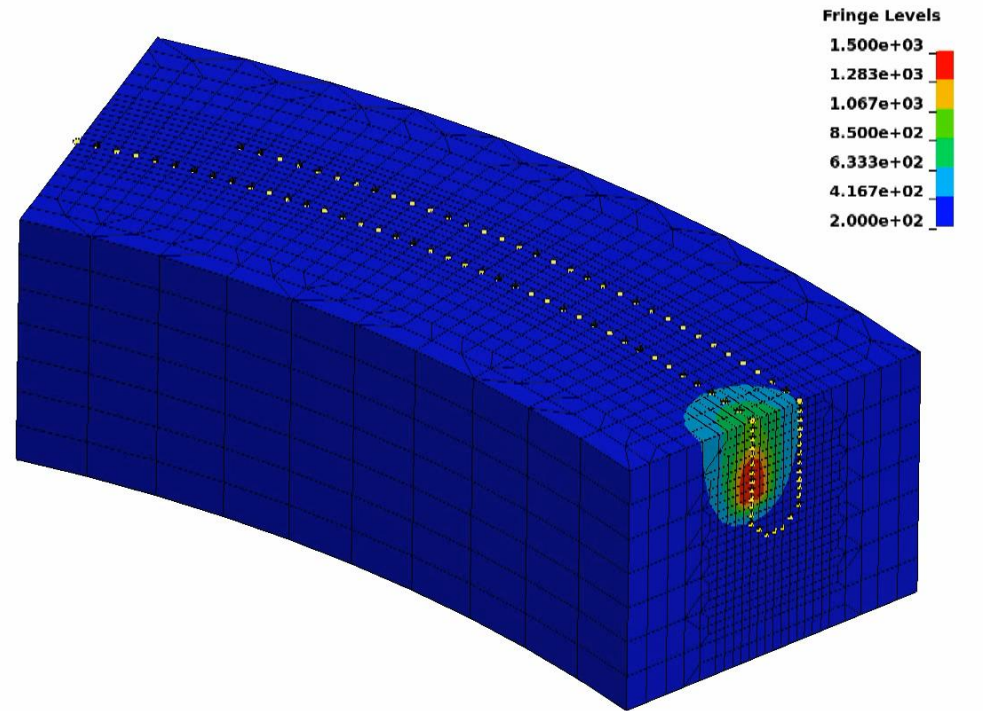

Modelling line welding processes

■ *BOUNDARY_THERMAL_WELD_TRAJECTORY

- defines a volumetric heat source
- motion along a trajectory (nodal path)
- prescribed velocity, possibly as function of time
- user can choose from a list of equiv. heat sources

■ Works in thermal-only and coupled analyses

■ Applicable to solids and thermal thick shells

■ Different possibilities to define aiming direction

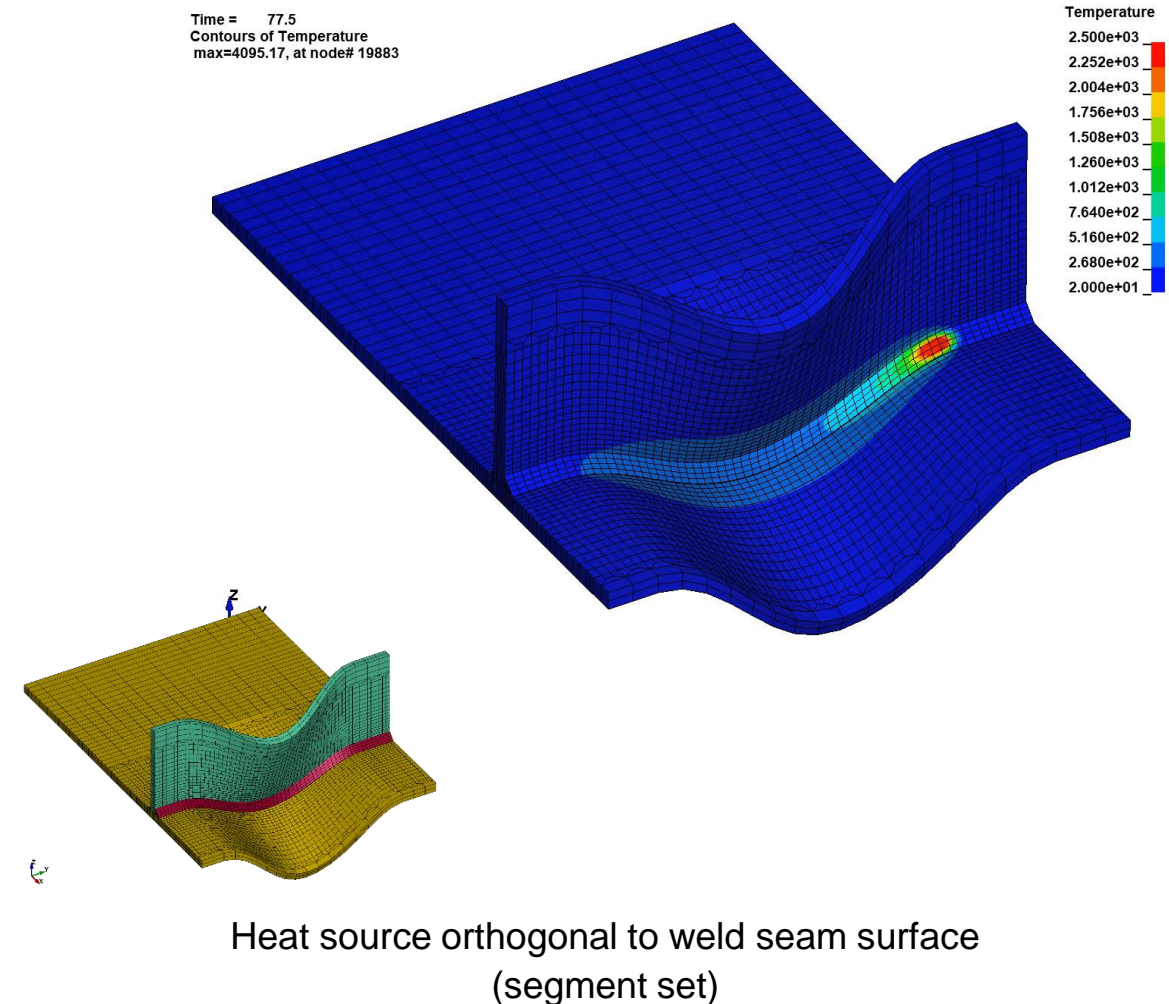
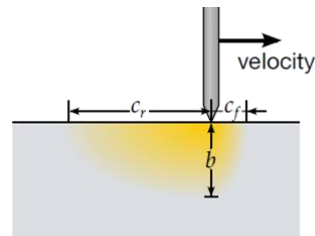

Modelling line welding processes

*BOUNDARY_THERMAL_WELD_TRAJECTORY

- defines a volumetric heat source
- motion along a trajectory (nodal path)
- prescribed velocity, possibly as function of time
- user can choose from a list of equiv. heat sources

■ Works in thermal-only and coupled analyses

■ Applicable to solids and thermal thick shells

■ Different possibilities to define aiming direction

nodes provided by user ●

virtual nodes ●

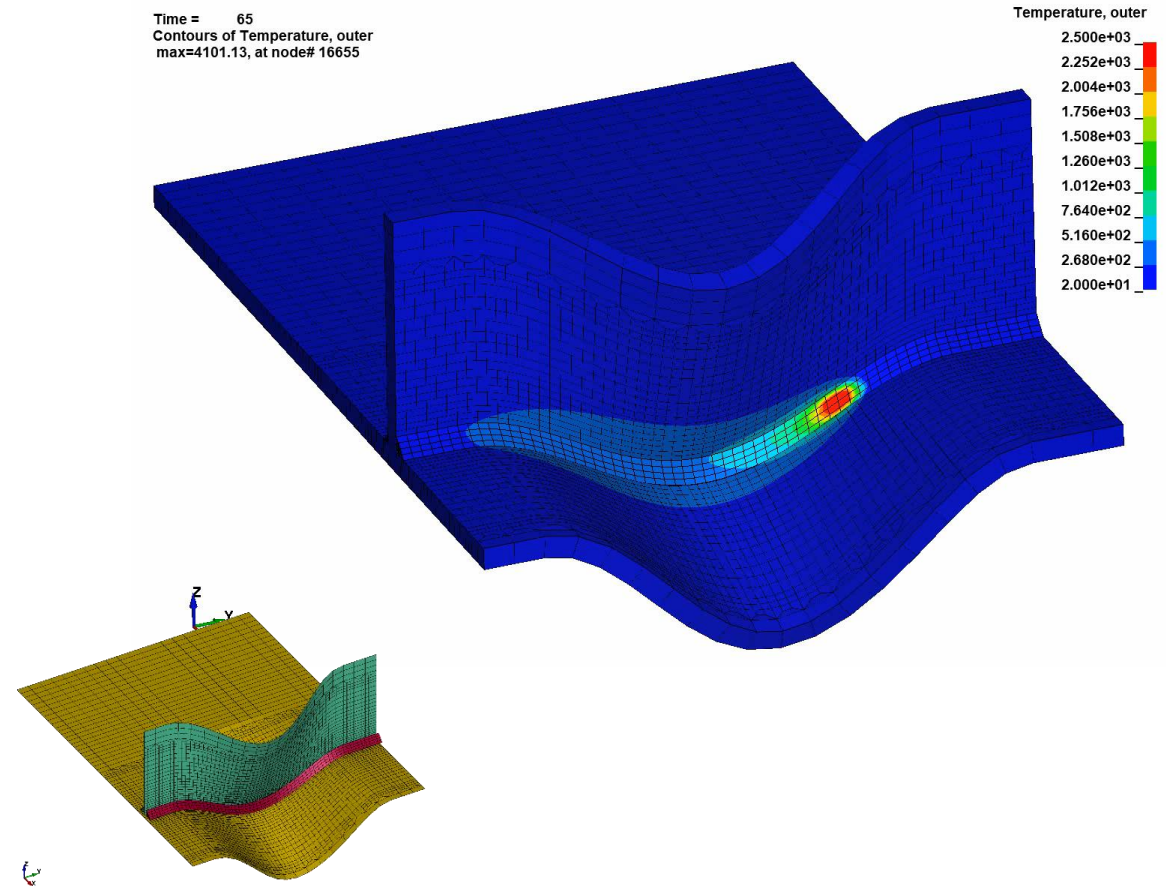
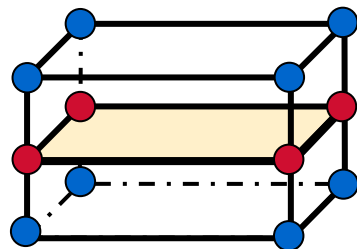

Heat source orthogonal to weld seam surface (segment set)

Modelling line welding processes

- `*BOUNDARY_THERMAL_WELD_TRAJECTORY`
 - defines a volumetric heat source
 - motion along a trajectory (nodal path)
 - prescribed velocity, possibly as function of time
 - user can choose from a list of equiv. heat sources
- Works in thermal-only and coupled analyses
- Applicable to solids and thermal thick shells
- Different possibilities to define aiming direction
- Additional rotation and translation (load curves)

Influence of oscillations for...

... LCROT

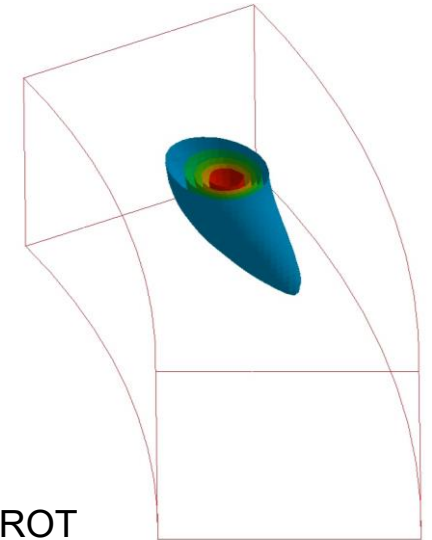

... LCLAT

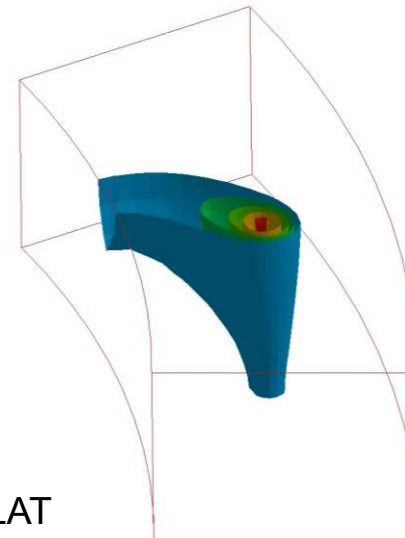

... LCMOV

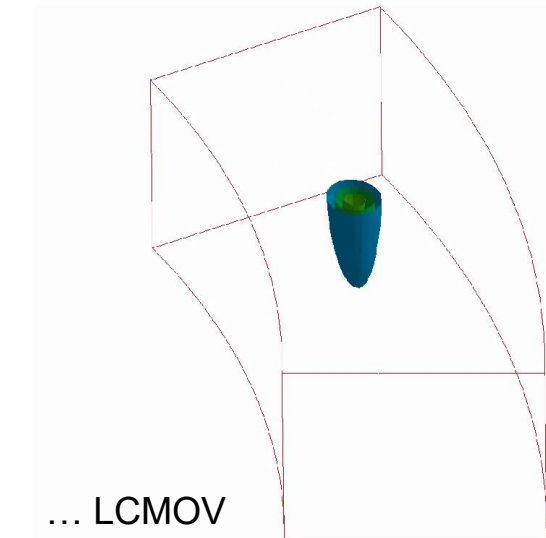

Modelling line welding processes

- `*BOUNDARY_THERMAL_WELD_TRAJECTORY`
 - defines a volumetric heat source
 - motion along a trajectory (nodal path)
 - prescribed velocity, possibly as function of time
 - user can choose from a list of equiv. heat sources
- Works in thermal-only and coupled analyses
- Applicable to solids and thermal thick shells
- Different possibilities to define aiming direction
- Additional rotation and translation (load curves)
- Thermal dumping is possible

temperature field, NCYC = 1

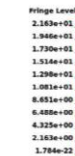
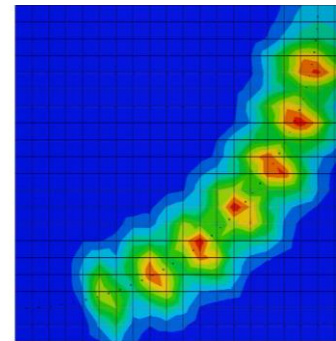

Peak temperature = 21.6

temperature field, NCYC = 10

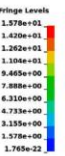
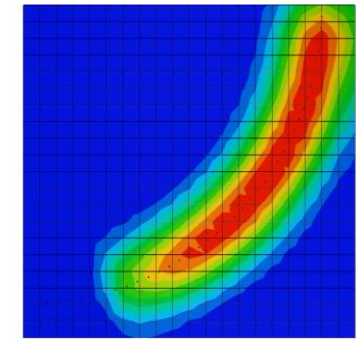

Peak temperature = 15.8

Laser heating and laser cutting

- Local heating of a surface by a laser with a certain position and orientation
- Material evaporates and topology of cut part changes
- LS-DYNA implementation with *BOUNDARY_FLUX_TRAJECTORY
 - surface flux boundary conditions that follows a prescribed path (node set)
 - resulting surface heat distribution depends on base distribution and current orientation of laser and surface
 - element erosion based on maximum temperature
 - newly exposed segments are accounted for

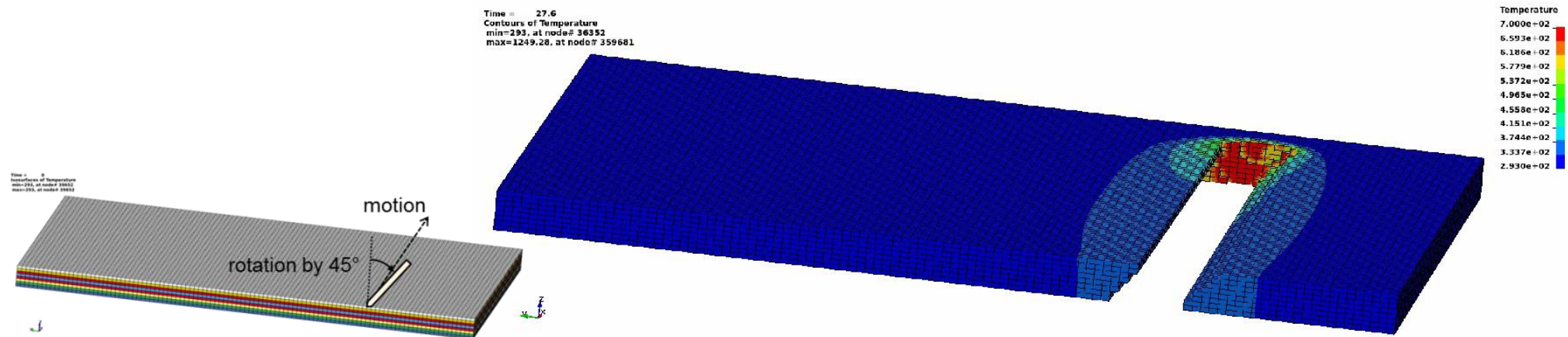

Laser heating and laser cutting

*BOUNDARY_FLUX_TRAJECTORY

- nodal path not necessarily defined on the cut part

- tilting changes projection on the surface
- change of intensity can be balanced

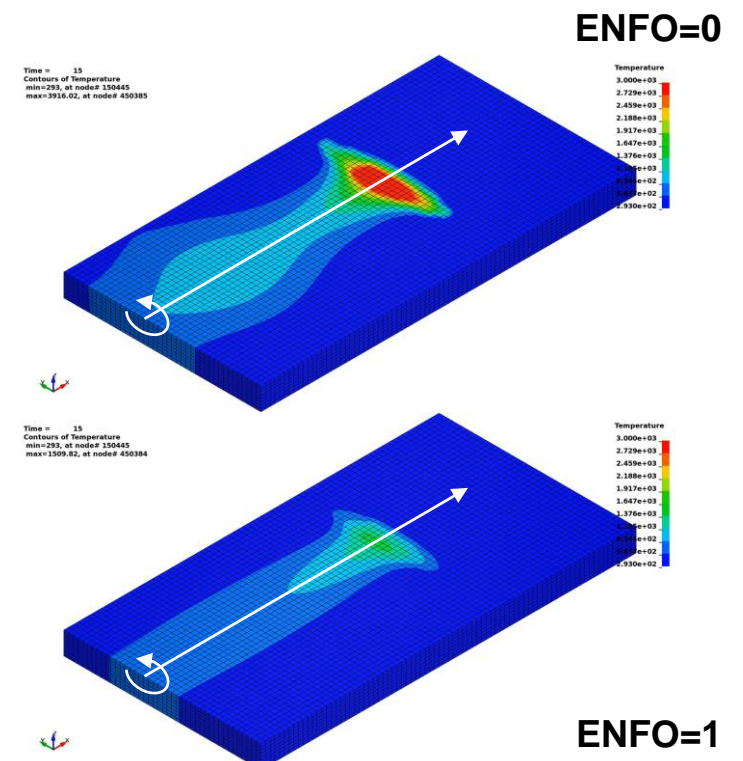
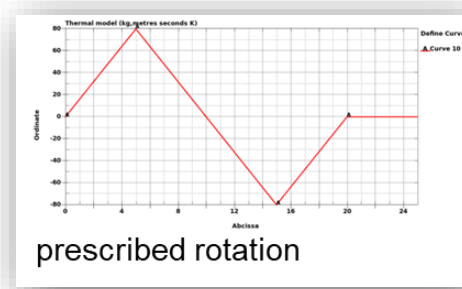
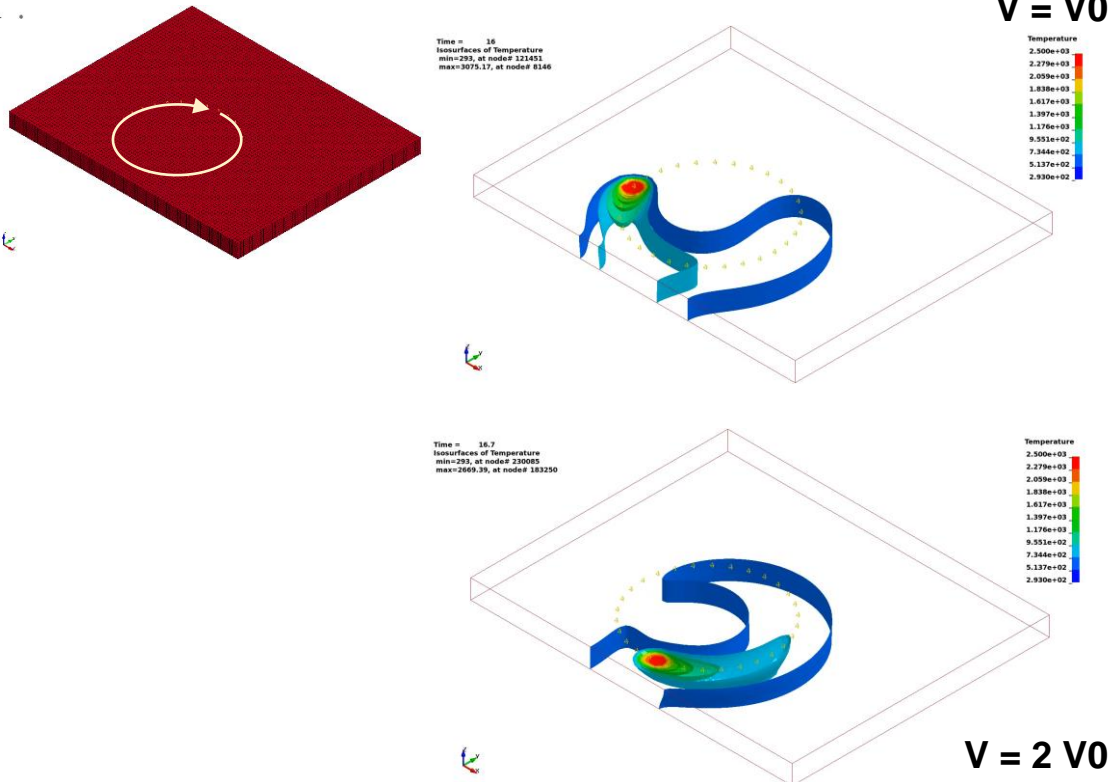

Resistance spot welding (RSW)

■ Standard modelling approaches for RSW

- Use a detailed and coupled (EM, thermal, structure) simulation
- Use an equivalent heat source and calibrate its power and shape
- **For large assemblies and hundreds of spot welds neither approach is feasible!**

■ *BOUNDARY_TEMPERATURE_RSW

- Direct temperature definition (Dirichlet condition) for the weld nugget and the heat affected zone for the **thermal** solver
- Constraint condition only active during the welding
- Very good prediction of deflections in large assemblies
- A HAZ can be additionally accounted for

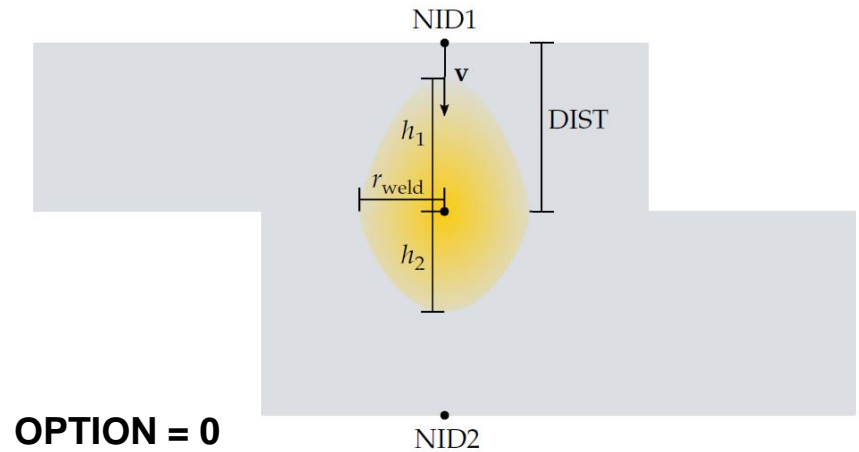

OPTION = 0

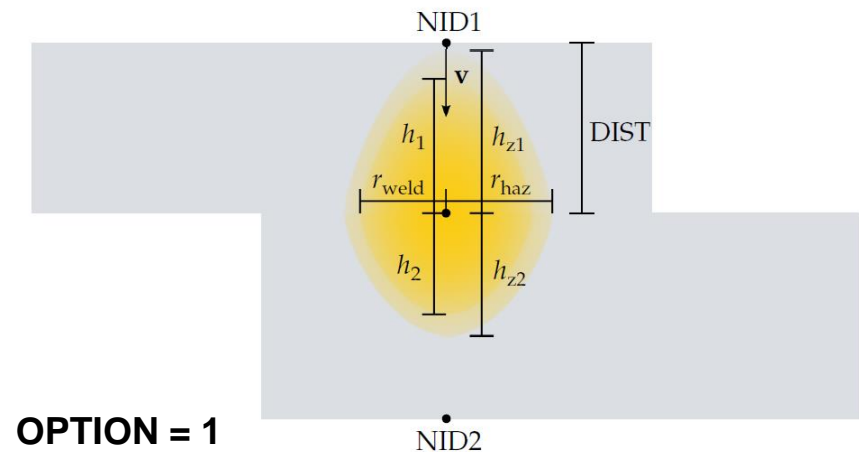

OPTION = 1

Resistance spot welding (RSW)

- Temperature in the weld nugget
 - prescribed at the center, boundary of nugget, and boundary of HAZ
 - quadratic approximation inside the nugget
 - linear approximation in the HAZ
- Boundary condition active between BIRTH and DEATH times
- Load curve input (LCIDT) for temperature scaling factor as function of normalized time

linear temp increase,
BIRTH=0.1, DEATH=0.9

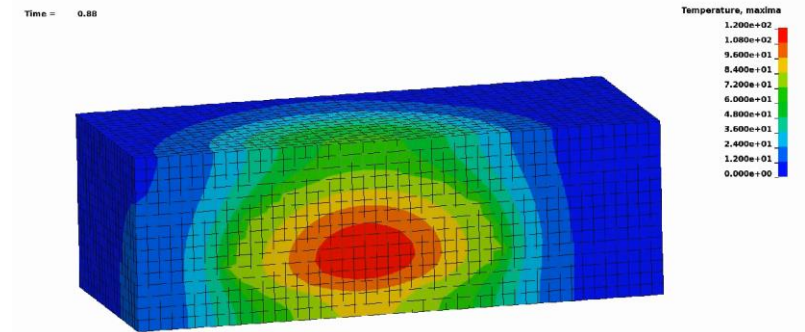

peak temp. profile, horizontal

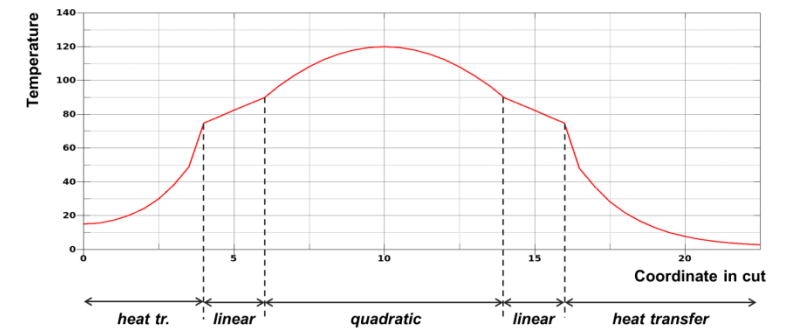

Content

- Boundary Conditions I

- Coupling Strategies
 - Standard Two-Way Coupling
 - One-Way Coupling with *LOAD_THERMAL_BINOUT

- Boundary Conditions II

- Material Modelling

- Thermal Contact Algorithms

Data Transfer and Simulation Principles

- Default strategy in LS-DYNA is a 2-way coupling
 - Staggered weak approach
 - Two solvers run in parallel and share data
 - Thermal time step is independent of the mechanical time step
- Data transfer

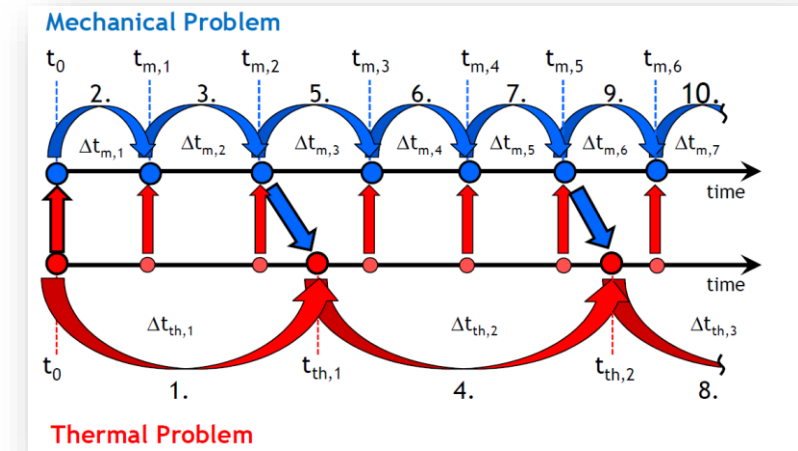

Mechanical Calculations

- Based on current temperature, calculate:
 - Plastic work
 - Part contact gap thickness
 - Temperature dependent material
 - Thermal expansion
- Update geometry

Thermal Calculations

- Based on current geometry, calculate:
 - Heat from plastic work
 - Contact conductance from gap thickness and contact pressure
 - Heat from interface friction
- Update temperature

2-way coupled Approach – Examples for possible Applications

Hot forming

- Constantly changing contact status
- Heat transfer between blank and tools is pressure dependent
- Heat generation from contact friction
- Energy conversion from plastic work to heat

Laser cutting

- Surface heat source (*BOUNDARY_FLUX_TRAJECTORY) moving along a prescribed path
- Propagation to newly exposed surfaces after element erosion
 - Element erosion is defined in mechanical solver
 - Constantly changing topology

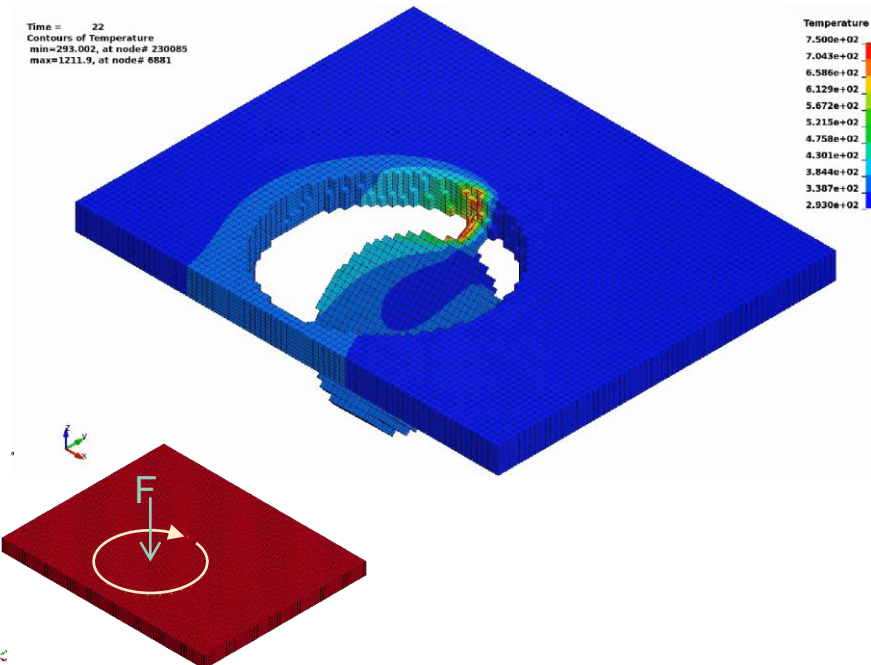
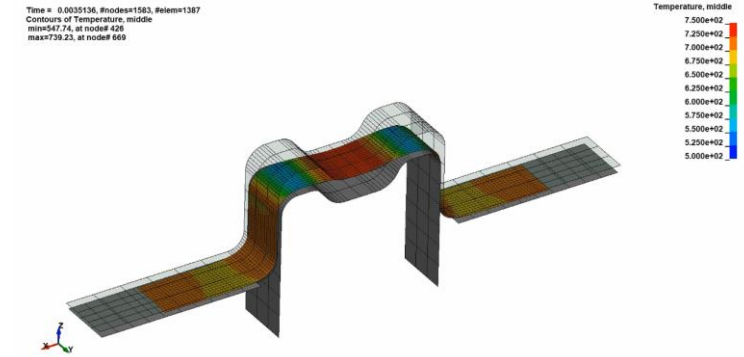

Motivation for 1-way Coupling

- For some assembly stages the effect of structural deformation onto the thermal simulation is negligible
 - Distortion and/or material phase evolution due the thermal distribution are of interest to the user
- Results of a thermal run serves as loading for structure simulation with `*LOAD_THERMAL_D3PLOT`
 - Evolution in time of temperature distribution linearly interpolated between the output time steps
 - Thermal thick shell feature is supported also for the structure-only simulation
 - Temperature results are read from the d3plot file of the thermal run
- Challenges with this approach:
 - Complex input file format (d3plot) to be generated by a mapping tool
 - Meshes (models!) for both simulations have to coincide
 - Time scaling has to match as well
- Implemented more flexible `*LOAD_THERMAL_BINOUT` to read data from one or more LSDA database(s)

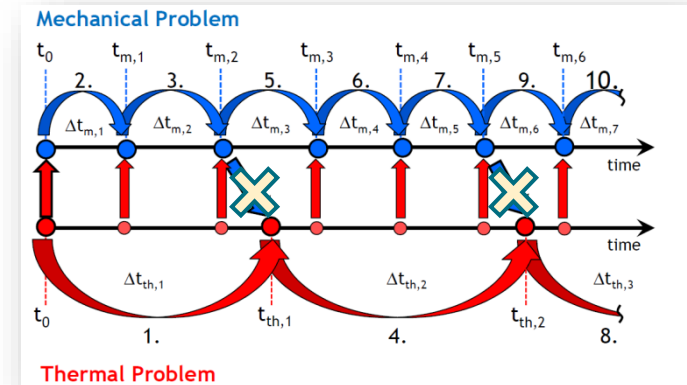

*LOAD_THERMAL_BINOUT

	1	2	3	4	5	6	7	8
Card 1	DEFTEMP							
Card 2	Filename							
Card 3	START	TSF						

■ Aims and scope of the new keyword

- Use flexible and open LSDA data format to define thermal loading of a structure
- Required structure of LSDA files matches the TPRINT section in LS-DYNA binout file, so results from thermal and from coupled LS-DYNA runs can be used without further modification
- Only partial overlap between meshes should be required
- Allow for a sequential thermal loading and for an easy modification of the sequence

*LOAD_THERMAL_BINOUT

	1	2	3	4	5	6	7	8
Card 1	DEFTEMP							
Card 2	Filename							
Card 3	START	TSF						

- File name of thermal run given in keyword
- Thermal thick shells are accounted for
- Time step sizes do not have to match

Welding Example:

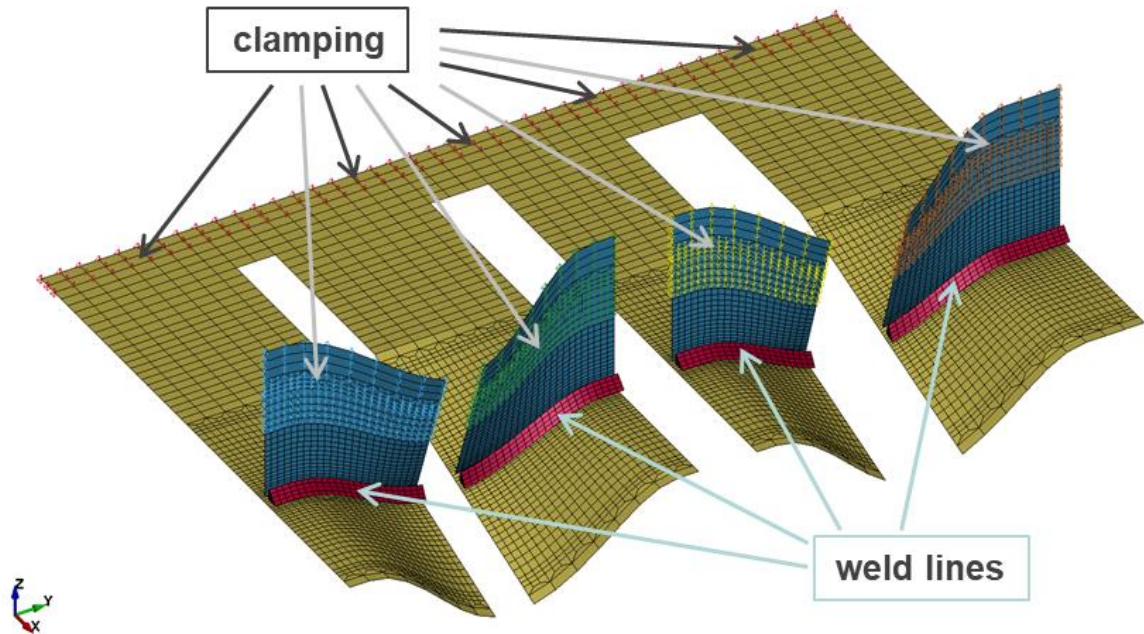

*LOAD_THERMAL_BINOUT

	1	2	3	4	5	6	7	8
Card 1	DEFTEMP							
Card 2	Filename							
Card 3	START	TSF						

- File name of thermal run given in keyword
- Thermal thick shells are accounted for
- Time step sizes do not have to match

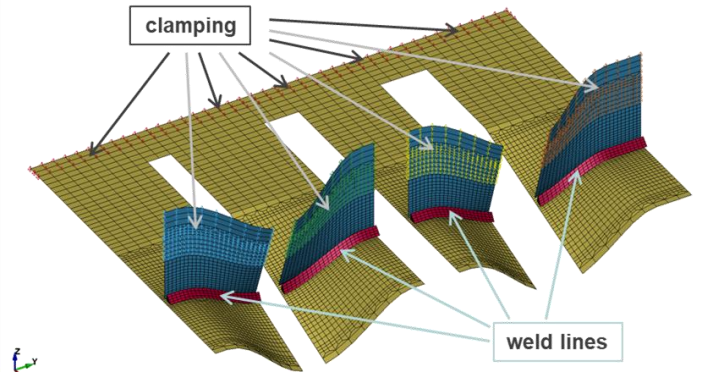

Thermal run:

Time = 22.5
Contours of Temperature, middle
max=2773.05, at node# 71894

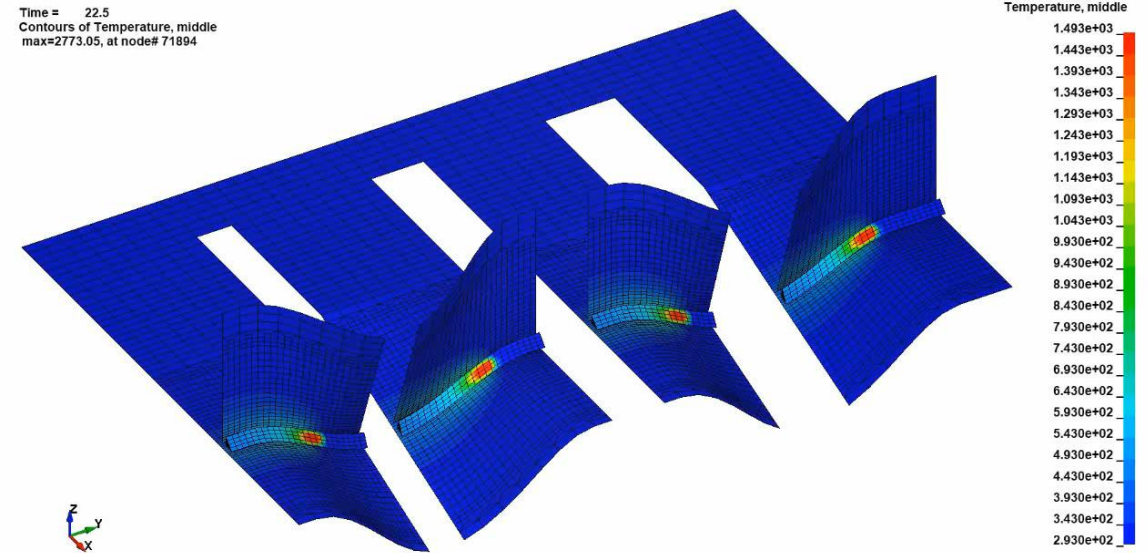

*LOAD_THERMAL_BINOUT

	1	2	3	4	5	6	7	8
Card 1	DEFTEMP							
Card 2	Filename							
Card 3	START	TSF						

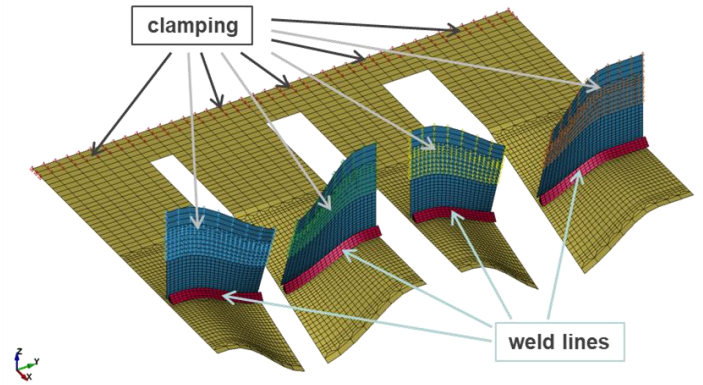

Structure run with thermal loading:

Time = 30
Contours of Temperature
max=2721.48, at node# 19883

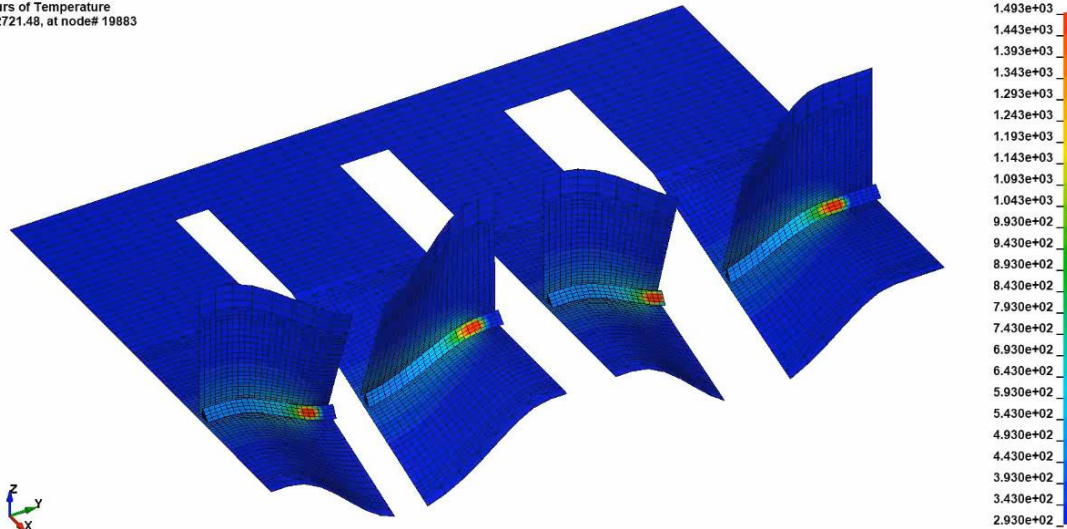

Temperature

Time = 30
Contours of Effective Stress (v-m)
reference shell surface
max=406.402, at elem# 44202

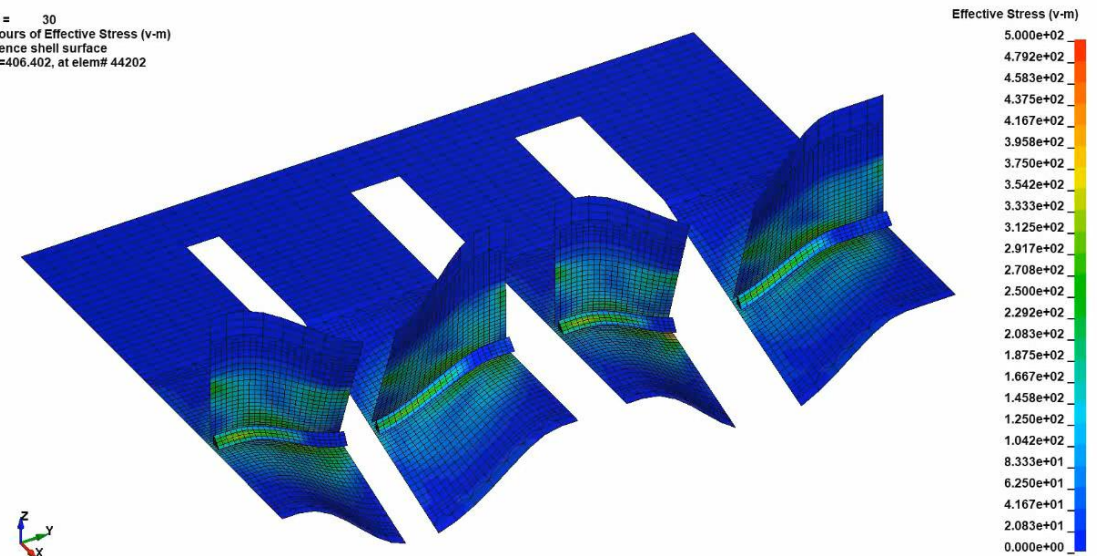

von Mises stress

*LOAD_THERMAL_BINOUT

	1	2	3	4	5	6	7	8
Card 1	DEFTEMP							
Card 2	Filename							
Card 3	START	TSF						

- File name of the input is to be given in the keyword
- Thermal thick shells are accounted for
- Time step sizes do not have to match
- Only **partial overlap** of the meshes is required
 - Data transfer based on user given ID of the nodes
 - Default temperature is used for those nodes of the structure simulations that are not included in the thermal run

Thermal Run:

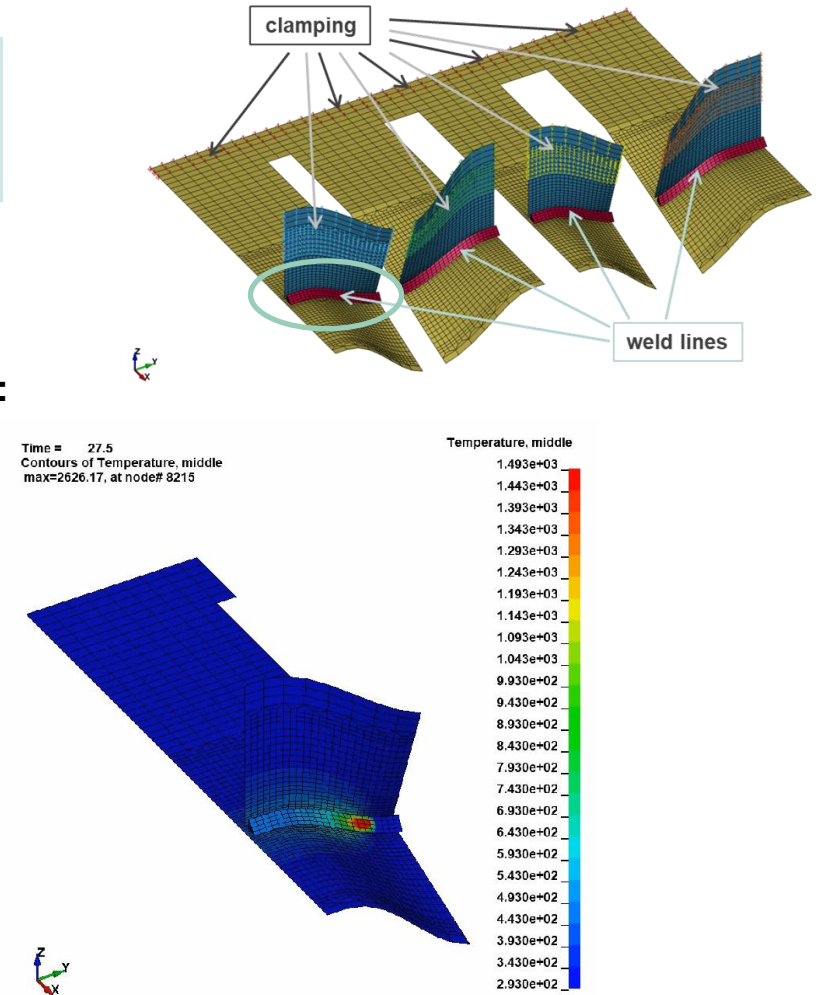

*LOAD_THERMAL_BINOUT

	1	2	3	4	5	6	7	8
Card 1	DEFTEMP							
Card 2	Filename							
Card 3	START	TSF						

- File name of the input is to be given in the keyword
- Thermal thick shells are accounted for
- Time step sizes do not have to match
- Only **partial overlap** of the meshes is required
 - Data transfer based on user given ID of the nodes
 - Default temperature is used for those nodes of the structure simulations that are not included in the thermal run

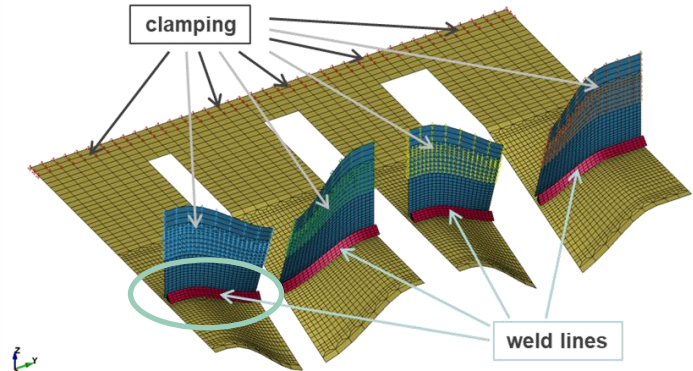

Mechanical Run:

Time = 28
Contours of Temperature
max=2509.67, at node# 8215

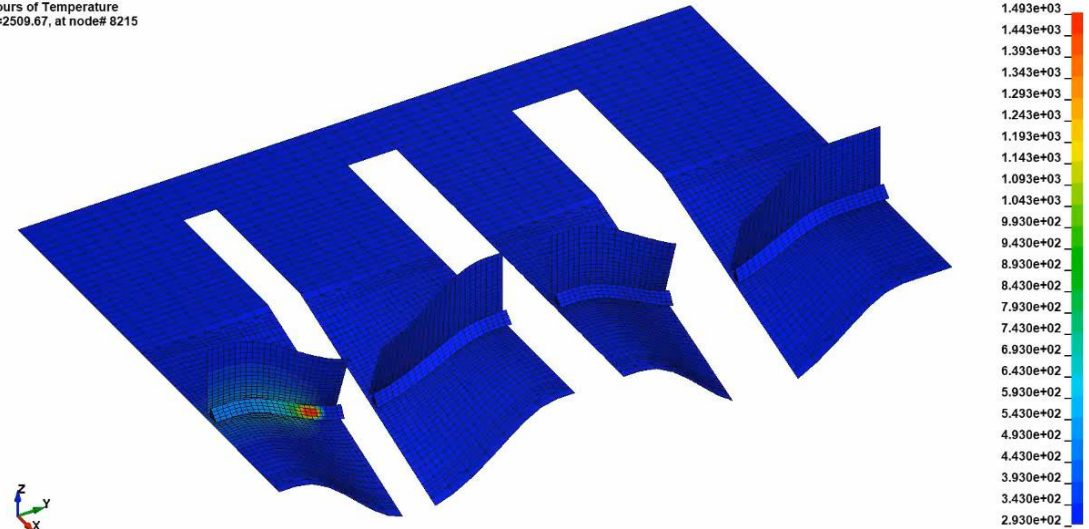

Temperature

*LOAD_THERMAL_BINOUT

	1	2	3	4	5	6	7	8
Card 1	DEFTEMP							
Card 2	Filename							
Card 3	START	TSF						

- Multiple thermal runs can be read in
- Each thermal run with time offset START
- Compensation for a scaling in time with TSF

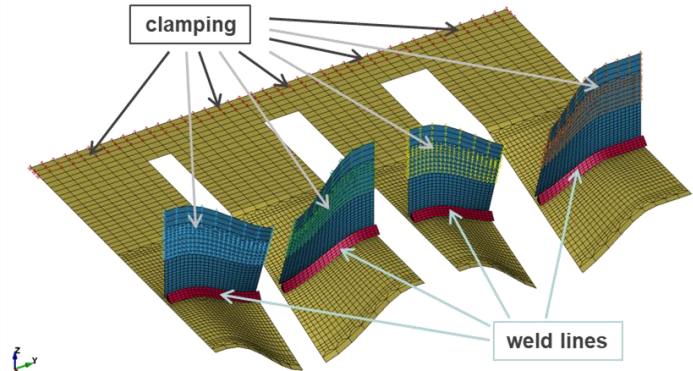

Structure Run:

Time = 132
Contours of Temperature
max=2694.62, at node# 20057

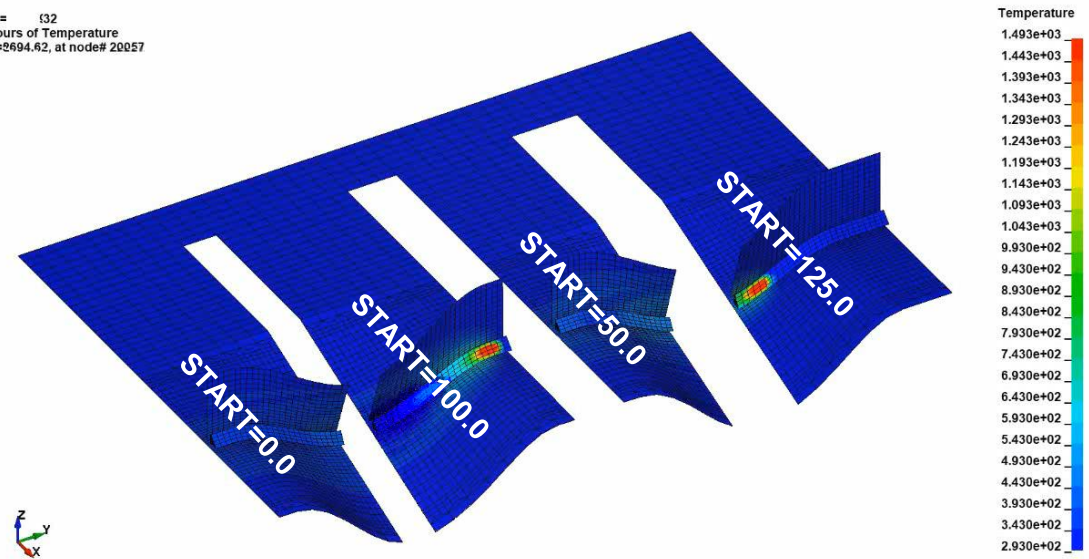

Thermal Runs:

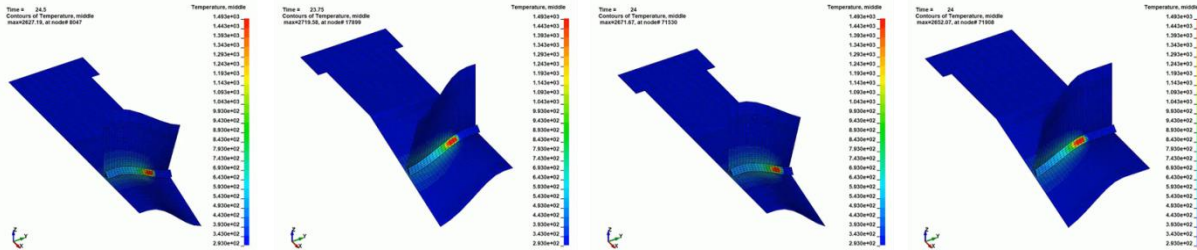

Content

- Boundary Conditions I
- Coupling Strategies
- Boundary Conditions II
 - *LOAD_THERMAL_RSW
- Material Modelling
- Thermal Contact Algorithms

Resistance spot welding (RSW)

- Successfully tested one-way coupled approach:
 - *BOUNDARY_TEMPERATURE_RSW as boundary condition in thermal-only simulation
 - *LOAD_THERMAL_BINOUT as loading condition in structure-only simulation
- In early design phases this approach might be numerically too expensive
- Further simplification
 - Skip the calculation of heat transfer altogether
 - Imprint the temperature field of the weld nugget directly as thermal load
 - Structure-only simulation
 - Adapt the HAZ, because there is no heat transfer into the surroundings

Resistance spot welding (RSW)

- Keyword *LOAD_THERMAL_RSW implemented
- Temperature profile in the weld nugget same as in the temperature boundary condition
 - Prescribed at the center, boundary of nugget, and boundary of HAZ
 - Quadratic approximation inside the nugget
 - Linear approximation in the HAZ
- Default temperature to be defined
 - Assumed outside the HAZ
 - Used before birth and after death of loading condition
- No heat transfer into surroundings
- Sharp edges in temperature distribution

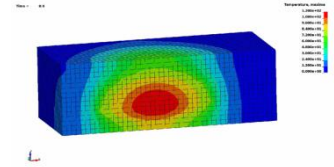

linear temp increase,
BIRTH=0.1, DEATH=0.9

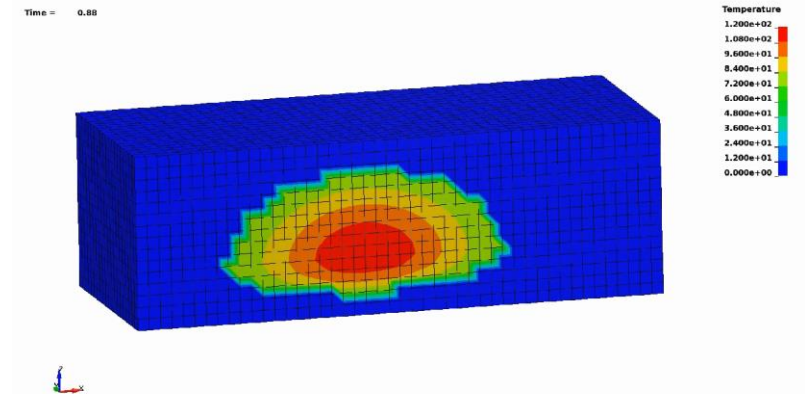

peak temp. profile, horizontal

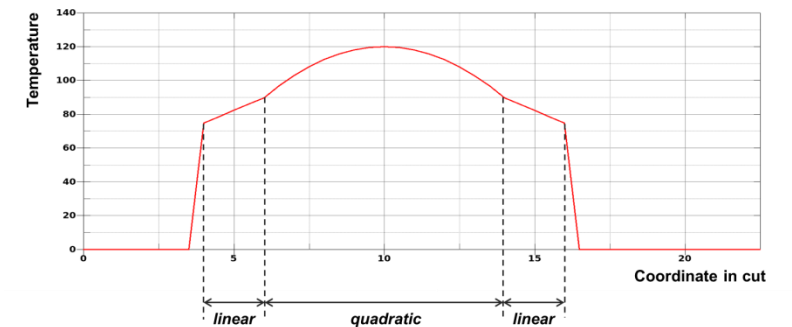

Content

- Boundary Conditions I

- Coupling Strategies

- Boundary Conditions II

- Material Modelling
 - *MAT_CWM / *MAT_270
 - *MAT_THERMAL_CWM / *MAT_T07
 - *MAT_GERNALIZED_PHASE_CHANGE / *MAT_254

- Thermal Contact Algorithms

*MAT_270 – Ghosting approach for welding

- Material has two different states
 - Elements are initially "Ghost" or "Silent" until activated at a specific temp.
 - Low stiffness
 - Negligible thermal expansion
 - After activation, material with temperature dependent
 - Mechanical properties of the base material
 - Von-Mises plasticity with mixed isotropic/kinematic hardening
 - Thermal expansion
- Anneal at specific temperature
 - Reset of plastic strain data
 - Perfect plasticity without accumulation of plastic strains

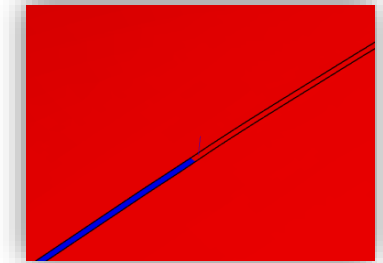

activation

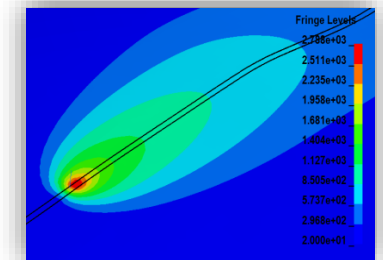

temperatures

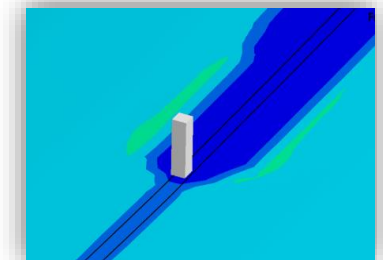

annealing

*MAT_T07 – Ghosting approach for welding

- Material has three different states
 - Material has a birth time
 - Elements are born as "Ghost" or "Silent" until activated at a specific temp.
 - For all three states, specific heat and thermal conductivity are to be defined
- The formulation allows to simulate multiple weld paths and additive manufacturing processes

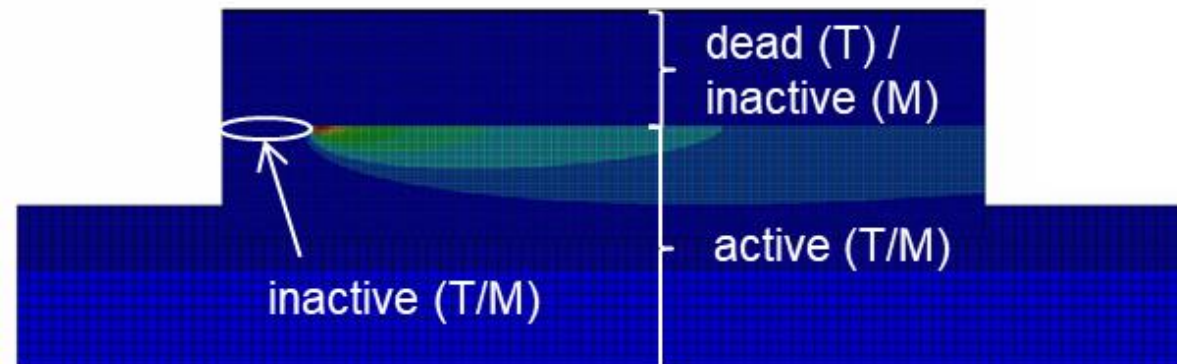

*MAT_254 – Overview

- up to 24 individual phases (= 552 possible phase change scenarios)
- phase changes in heating, cooling or in a temperature window
- user can chose from a list of phase change models for each scenario

- basic mechanical features:
 - elasto-plastic material with a von-Mises plasticity model
 - temperature and strain-rate effects
 - transformation induced strains and plasticity
 - thermal expansion
- any mechanical quantity α is determined by a rule of mixtures based on the current phase fractions x_i and the quantity α_i of phase i :

$$\alpha = \sum_{i=1}^{24} x_i \alpha_i$$

*MAT_254 – Overview

- elaborate features:
 - latent heat algorithm
 - calculation and output of additional pre-defined post-processing histories
 - calculation and output of additional user-defined history values
 - refers to *DEFINE_FUNCTION keyword
 - Possible input:
time, user-defined histories, phase concentrations, temperature, peak temperature, temperature rate, stress state, plastic strain data
 - enhanced annealing option by evolution equation for plastic strain depending on time and temperature

*MAT_254 – Phase transformation

	1	2	3	4	5	6	7	8
Card 3	PTLAW	PTSTR	PTEND	PTX1	PTX2	PTX3	PTX4	PTX5
Card 4	PTTAB1	PTTAB2	PTTAB3	PTTAB4	PTTAB5			

■ microstructural phase evolution

- up to 24 individual phases
- parametrization of the phase transformation to be given in a matrix-like structures (*DEFINE_TABLE_2D/3D)
- matrix input for
 - phase transformation law (2D)
 - start and end temperatures (2D)
 - transformation constants (2D)
 - temperature (rate) dependent parameters (3D)
 - parameters depending on eqv plastic strain (3D)

		to				
		ph. 1	ph. 2	ph. 3	...	ph. n
from	ph. 1	--	data	data	...	data
	ph. 2	data	--	data	...	data
	ph. 3	data	data	--	...	data
	⋮	⋮	⋮	⋮	--	⋮
	ph. n	data	data	data	...	--

*MAT_254 – Phase transformation

	1	2	3	4	5	6	7	8
Card 3	PTLAW	PTSTR	PTEND	PTX1	PTX2	PTX3	PTX4	PTX5
Card 4	PTTAB1	PTTAB2	PTTAB3	PTTAB4	PTTAB5			

■ Available phase transformation laws

- Koistinen-Marburger
- generalized Johnson-Mehl-Avrami-Kolmogorov (JMAK)
- Akerstrom (only cooling, *MAT_244)
- Oddy (only heating, *MAT_244)
- Phase Recovery I (only heating, Titanium)
- Phase Recovery II (only heating, Titanium)
- Parabolic Dissolution I (only heating, Titanium)
- Parabolic Dissolution II (only heating, Titanium)
- incomplete Koistinen-Marburger (only cooling, Titanium)

		to				
		ph. 1	ph. 2	ph. 3	...	ph. n
from	ph. 1	--	data	data	...	data
	ph. 2	data	--	data	...	data
	ph. 3	data	data	--	...	data
	⋮	⋮	⋮	⋮	--	⋮
	ph. n	data	data	data	...	--

*MAT_254 – Phase transformation

	1	2	3	4	5	6	7	8
Card 3	PTLAW	PTSTR	PTEND	PTX1	PTX2	PTX3	PTX4	PTX5
Card 4	PTTAB1	PTTAB2	PTTAB3	PTTAB4	PTTAB5	PTTAB6		

■ Johnson-Mehl-Avrami-Kolmogorov (JMAK):

- Evolution equation:

$$\frac{dx_b}{dt} = n(T)(k_{ab}x_a - k'_{ab}x_b) \left(\ln \left(\frac{k_{ab}(x_a + x_b)}{k_{ab}x_a - k'_{ab}x_b} \right) \right)^{\frac{n(T)-1.0}{n(T)}}$$

$$k_{ab} = \frac{x_{eq}(T)}{\tau(T, \varepsilon^p)} f(\dot{T}), k'_{ab} = \frac{1.0 - x_{eq}(T)}{\tau(T, \varepsilon^p)} f'(\dot{T}),$$

$$\tau(T, \varepsilon^p) = \tau^0(T) \cdot \alpha(\varepsilon^p)$$

- incremental form (isothermal case)

$$x_b = x_{eq}(T)(x_a + x_b) \left(1 - e^{-\left(\frac{t}{\tau(T, \varepsilon^p)}\right)^{n(T)}} \right)$$

- Parameter:

- PTTAB1: $n(T)$
- PTTAB2: $x_{eq}(T)$
- PTTAB3: $\tau^0(T)$
- PTTAB4: $f(\dot{T})$
- PTTAB5: $f'(\dot{T})$
- PTTAB6: $\alpha(\varepsilon^p)$

*MAT_254 – Phase transformation validation

- influence of parameter $n(T)$ on isothermal transformation

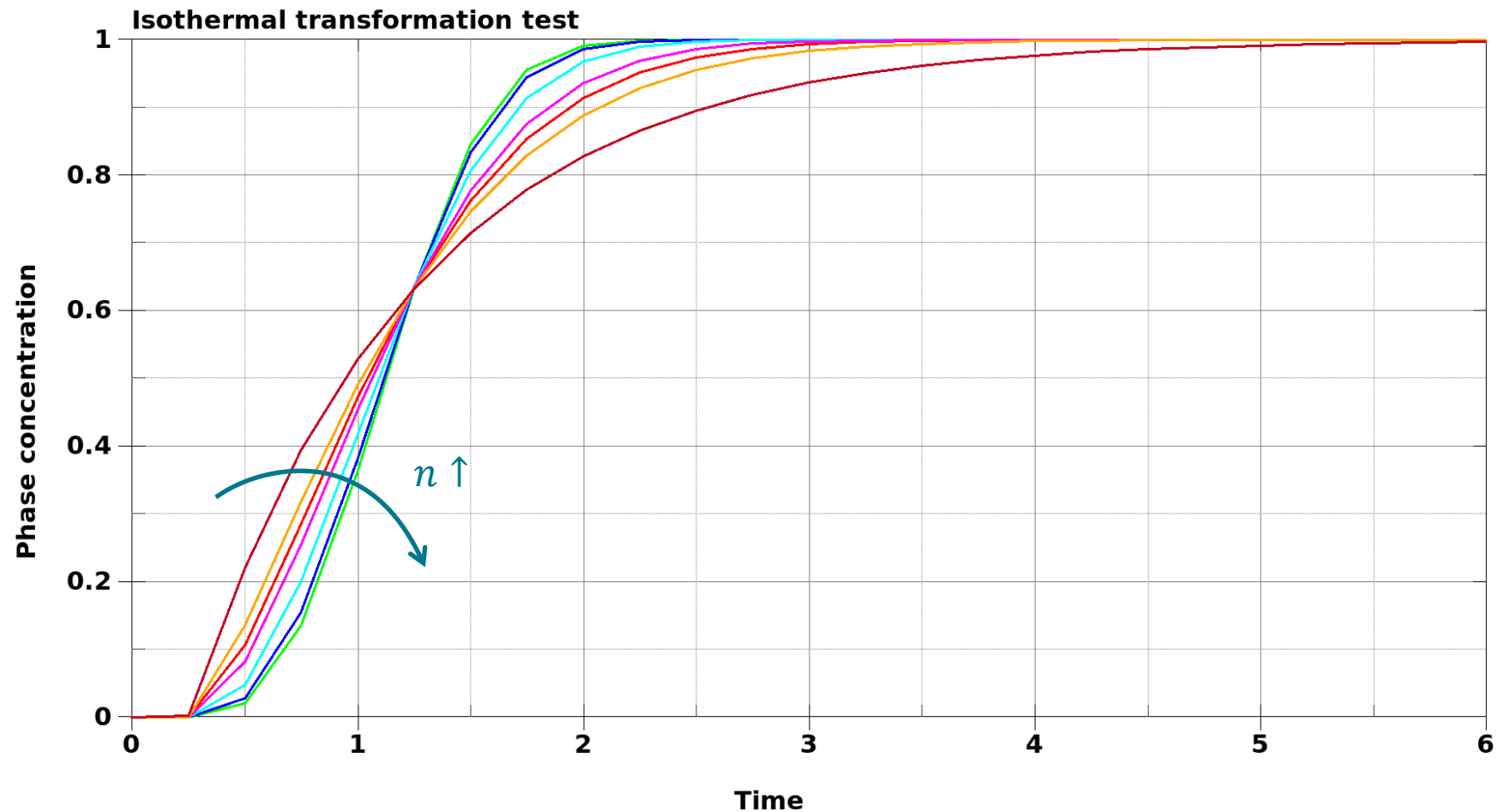

*MAT_254 – Phase transformation validation

- influence of parameter $x_{eq}(T)$ on isothermal transformation

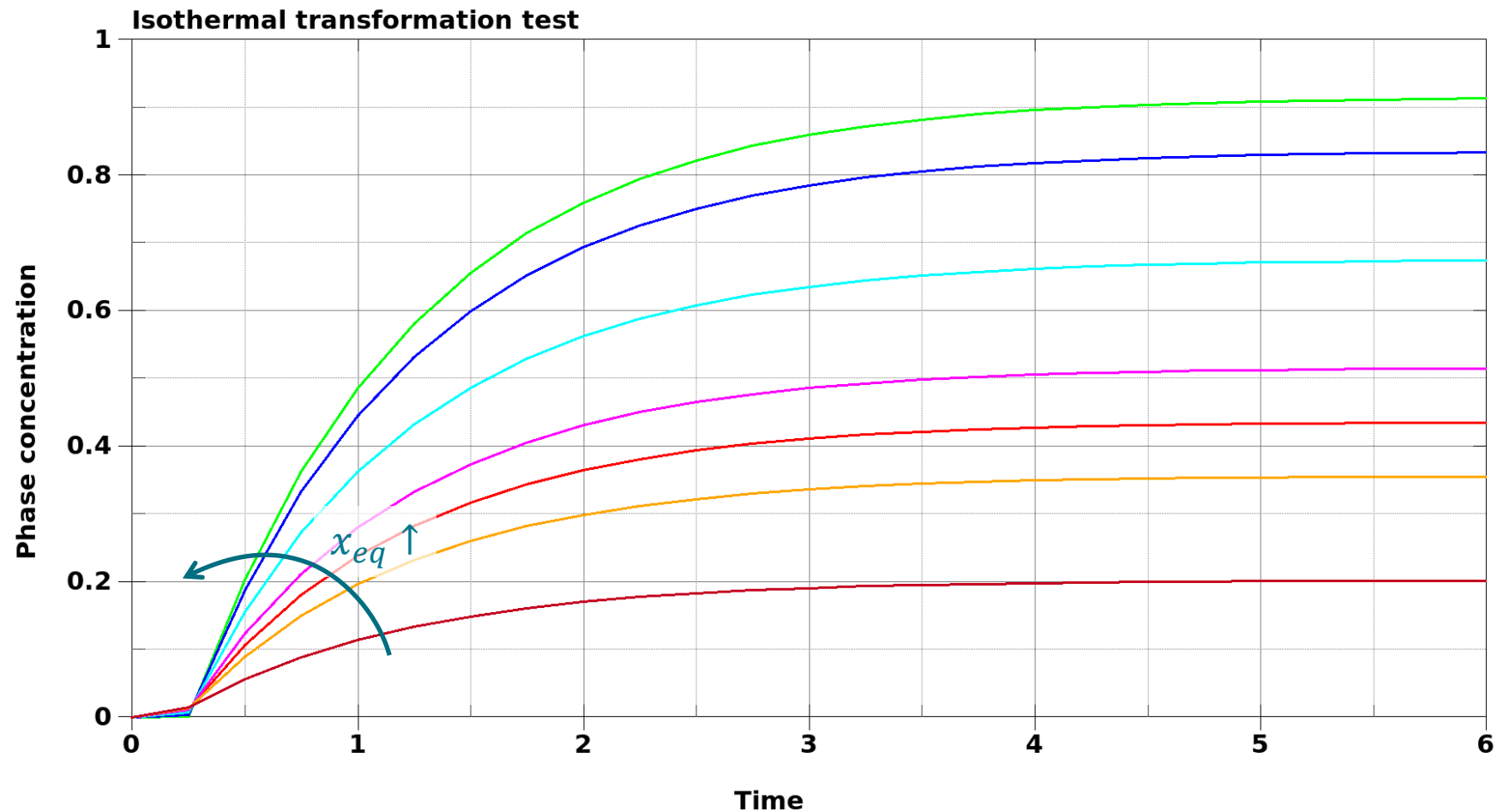

*MAT_254 – Phase transformation validation

- influence of parameter $\tau(T)$ on isothermal transformation

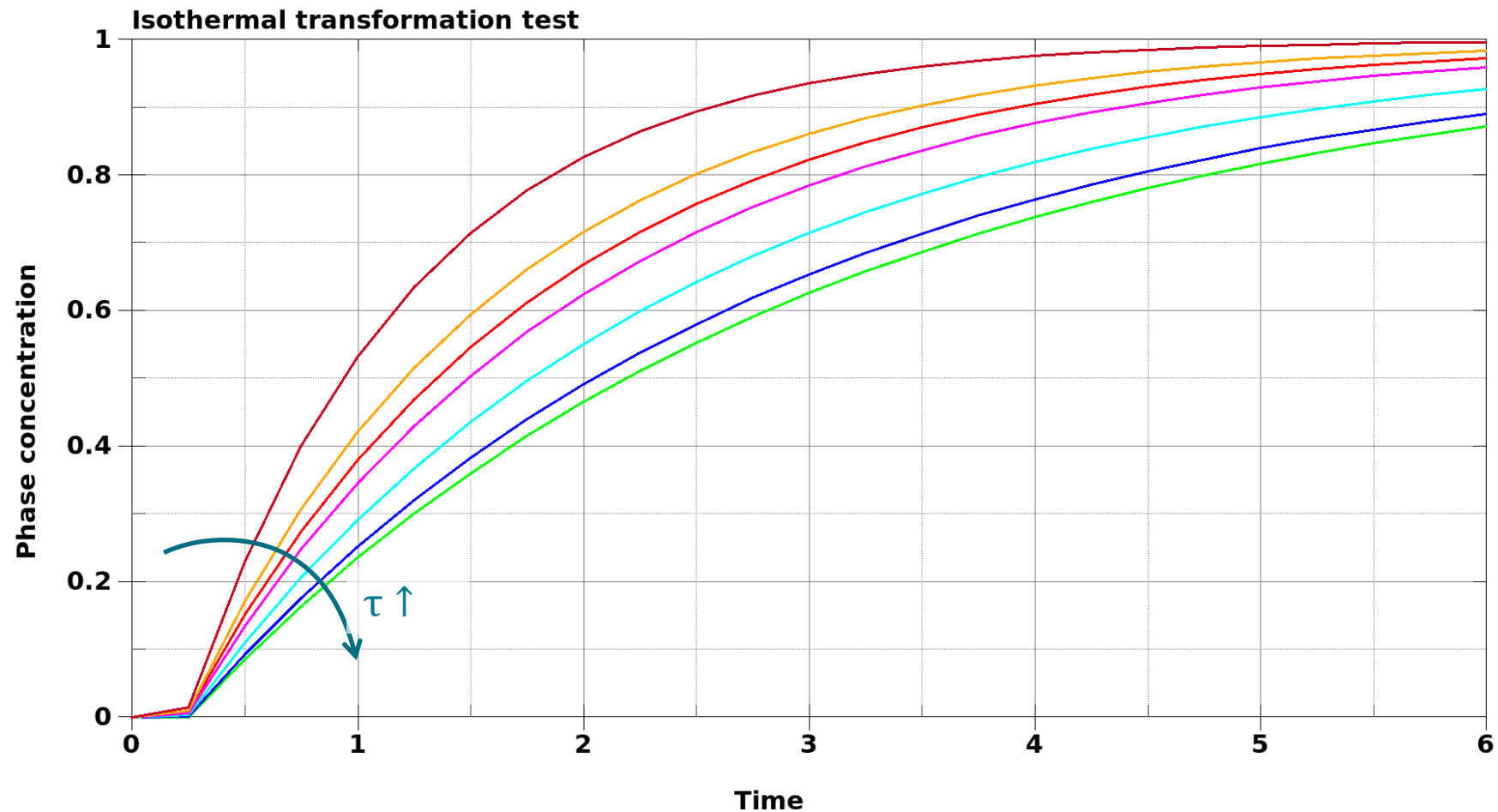

Content

- Boundary Conditions I

- Coupling Strategies

- Boundary Conditions II

- Material Modelling

- Thermal Contact Algorithms
 - `_TIED_WELD` option
 - thermal shell edge contacts

TIED_WELD contact formulations

- Motivation:
For welding processes without filler material, ghost approach is not applicable
- Basic features
 - Formulation can locally switch from sliding (un-welded) to tied (welded)
 - Switch is triggered by a temperature criterion
 - Welding only considered, if the gap between the contact partners are below a certain limit
 - Heat transfer coefficient also changes with welding
- MORTAR version available and recommended
- Available for solids and shells

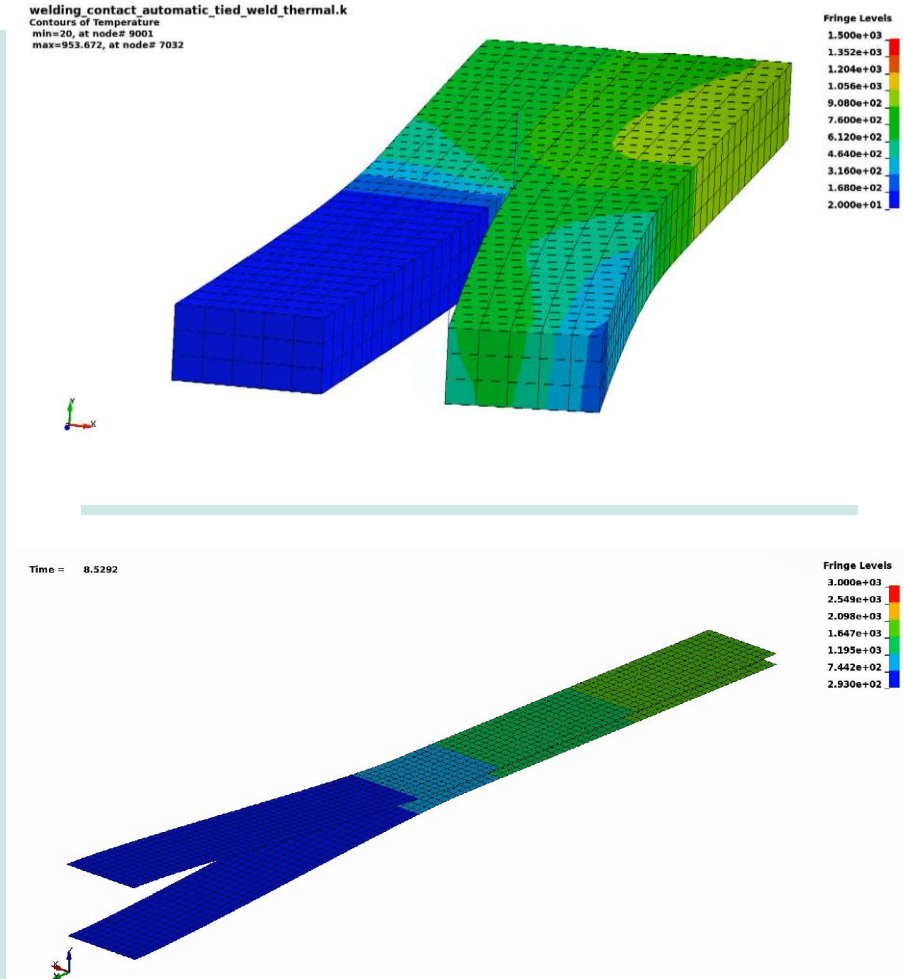

Heat Transfer over Shell Edges in Contact

- Situation so far:
 - heat transfer only available for surface to surface type contact formulations
 - for shell contacts only heat flux normal to shell surface implemented

- Thermal thick shells allow for reconstruction of two four-node surfaces at each shell edges for contact

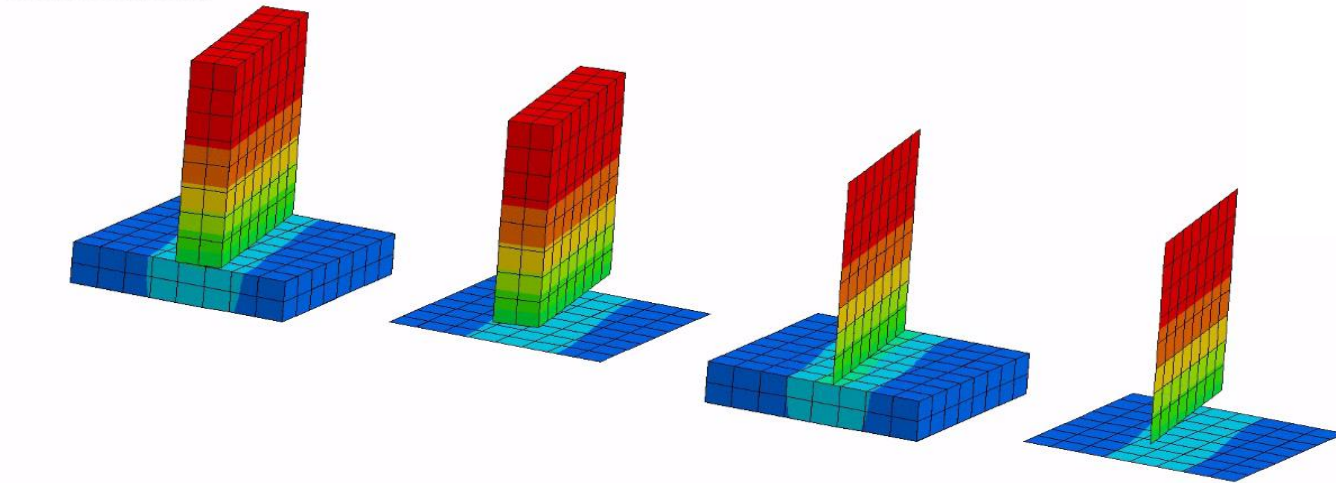

- contact segment 1
- contact segment 2
- nodes provided by user
- virtual nodes

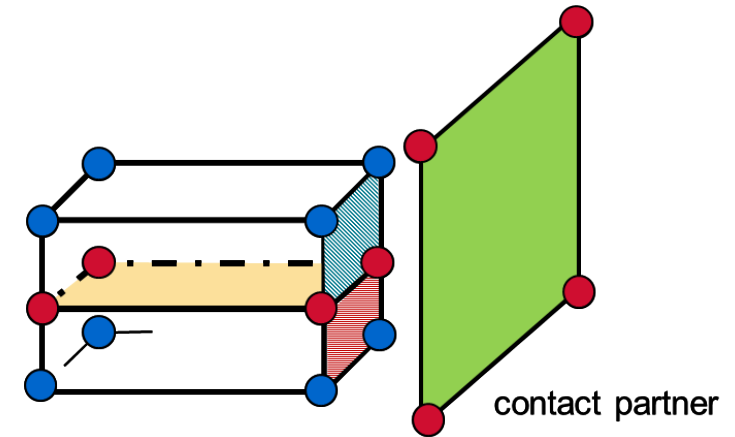

Summary

- Introduced tailored boundary conditions to comfortably simulate heat generation in welding processes
 - *BOUNDARY_THERMAL_WELD_TRAJECTORY for line welding
 - *BOUNDARY_FLUX_TRAJECTORY for laser heating and laser cutting
 - *BOUNDARY_TEMPERATURE_RSW / *LOAD_THERMAL_RSW for resistance spot welds
- Presented new coupling keyword 'LOAD_THERMAL_BINOUT'
 - Flexible input in LSDA format
 - Input of multiple thermal runs with easy modification of the input order
- Discussion on different material formulations for assembly simulations
 - *MAT_THERMAL_CWM as temporally and thermally activated thermal material
 - *MAT_CWM / *MAT_270 as thermally activated temperature dependent structure material
 - *MAT_254 as state-of-the-art material formulation for phase transformations (UHS, Al6xxx, Ti6Al4V, ...)
- Brief summary of new features in the thermal contacts
 - TIED_WELD option to locally switch from sliding to tied contact
 - Heat transfer across shell edges can be accounted for



Thank you for your attention!

Questions: thomas.kloeppel@dynamore.de