

# Development of an optimised side crash concept for the battery-electric vehicle concept Urban Modular Vehicle

Michael Schäffer<sup>1</sup>, Marco Münster<sup>1</sup>, Ralf Sturm<sup>1</sup>, Horst E. Friedrich<sup>1</sup>

Institute of Vehicle Concepts, German Aerospace Center (DLR), Stuttgart, Germany

## 1 Introduction

As part of the DLR research project 'Next Generation Car' (NGC; Fig. 1), the German Aerospace Center (DLR) is investigating three new vehicle concepts in the field of transport: Urban Modular Vehicle (UMV), Safe Light Regional Vehicle (SLRV) and the Interurban Vehicle (IUV). The NGC project integrates the development of technologies, methods and tools of various vehicle concepts from across DLR's transport research. This work makes it possible for new ideas and innovations for future vehicles to be driven forward.

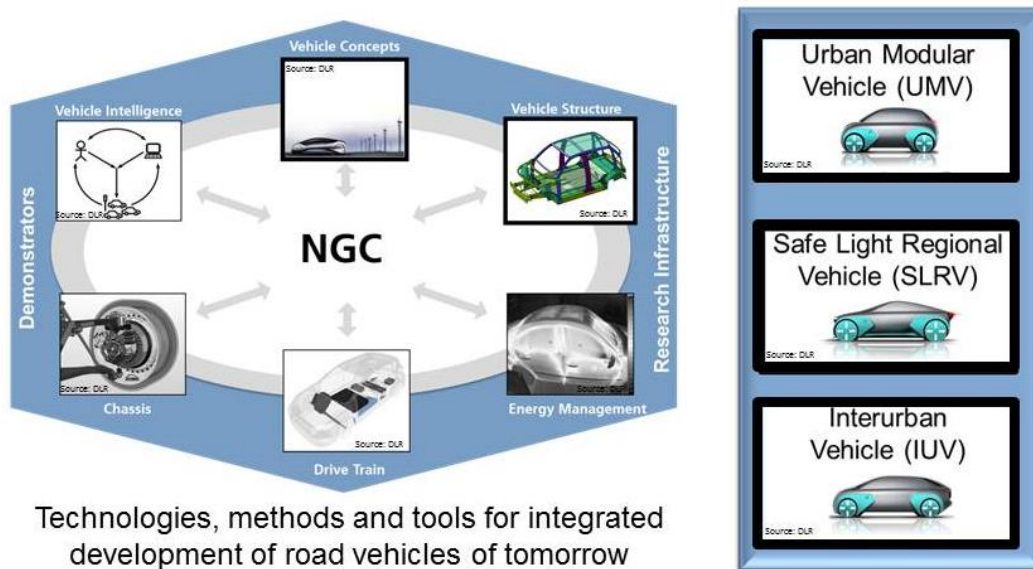

Fig. 1: Organisational structure of the Next Generation Car (NGC) project with the six working groups: Vehicle Concepts, Vehicle Structure, Energy Management, Drive Train, Chassis, Vehicle Intelligence and the three vehicles: Urban Modular Vehicle (UMV), Safe Light Regional Vehicle (SLRV), Interurban Vehicle (IUV). [1]

Today's vehicles and their body structures are characterised, in particular, by their drive technology, and by legislation. Most concepts have a traditional combustion engine at the front of the vehicle and a gearbox in the transmission tunnel.

Due to the electrification of vehicles, vehicle concepts and their body-in-white structures must be rethought. The integration of new components (e.g. the volume- and mass intensive battery) when developing electrified vehicles presents challenges in terms of the overall design of the vehicle, as well as vehicle safety. For example, the battery can be placed in the transmission tunnel in a 'T'-shaped design, or in a double floor.

It has been found that, when designing a vehicle body specifically for a battery-electric vehicle concept, a double floor has advantages over other solutions. [1] Therefore, this paper focuses on the development of an optimised side crash concept (side pole crash) for the battery-electric vehicle concept Urban Modular Vehicle.

## 2 Methodological approach

A side crash concept (side pole crash) was developed for the Urban Modular Vehicle concept. During the design of the concept, load path analyses, dimensioning and shape optimisation were applied to the floor concept to increase crash performance (see Fig. 2). The process shown below is used as an example, and is based on a door sill profile with energy-absorbing aluminium sandwich panels.

Each of the 9 steps shown in Fig. 2 is described in the paragraphs that follow in detail, and section 3 discusses the results achieved. This paper mainly focuses on steps 7 and 8 from Fig. 2, as well as the optimisations in these (e.g. multi-level optimisation of the door sill structure) to increase crash safety in the event of a side pole crash.

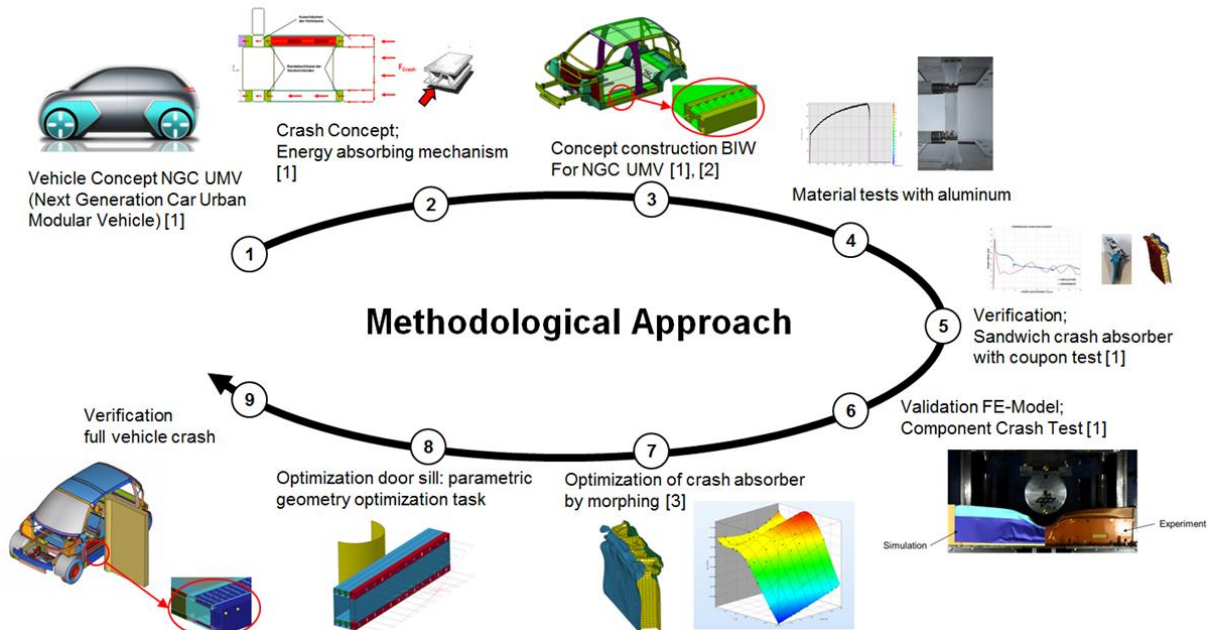

Fig.2: Methodological approach for development of side pole crash concept of a full electric, modular vehicle concept.

### Step 1:

The vehicle concept shown, Urban Modular Vehicle, is a modular and intelligent battery-electric vehicle. The modularity of the UMV is one of the main requirements of the concept, and therefore, of the development of a floor module. This modularity is, for example, most notable on the body structure. This offers the possibility of demonstrating various structures, from the Basic to Cargo, through to the fully autonomous Peplemover and Cargomover, whilst maintaining the structural concept (Fig. 3). [4]

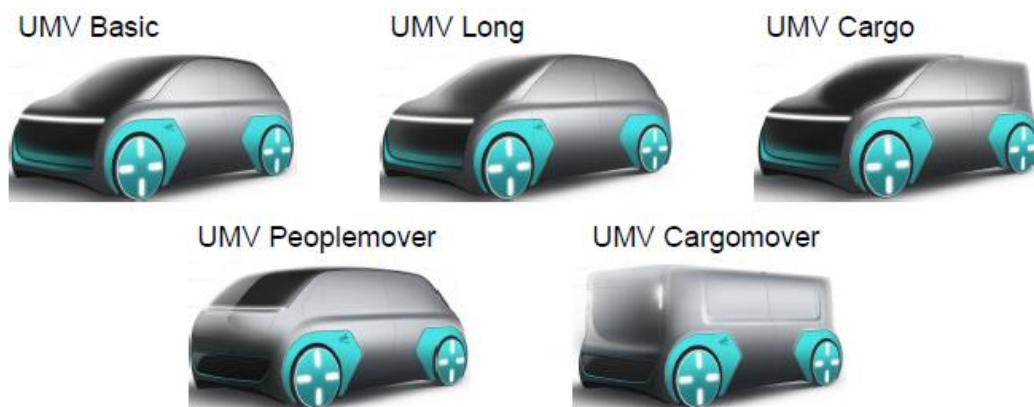

Fig.3: Example of the modularity of the UMV: Different derivatives on one modular system. [1]

**Step 2:**

To develop a crash concept, it is necessary to carry out a load path analysis so that the requirements can be met during a vehicle crash. This step involves the systematic analysis, evaluation and selection of different crash concepts for energy absorption. A promising solution here lies in the possibility of absorbing energy using a sandwich construction in the in-plane load.

Fig. 4 a) shows the load paths for the load case of a side pole crash. In this scenario, the door sill with the underlying energy absorber is primarily used to absorb energy. (Fig. 4 b)) The door sill inputs and transmits the force to the absorber (shown in red), which converts the kinetic energy into deformation work to prevent any intrusion into the battery box located behind it. This energy absorber can be implemented in various ways. One possibility is shown in Fig. 4 c). For sandwich constructions where the core is supported unidirectionally, deformation energy is primarily achieved in the sandwich core by buckling.

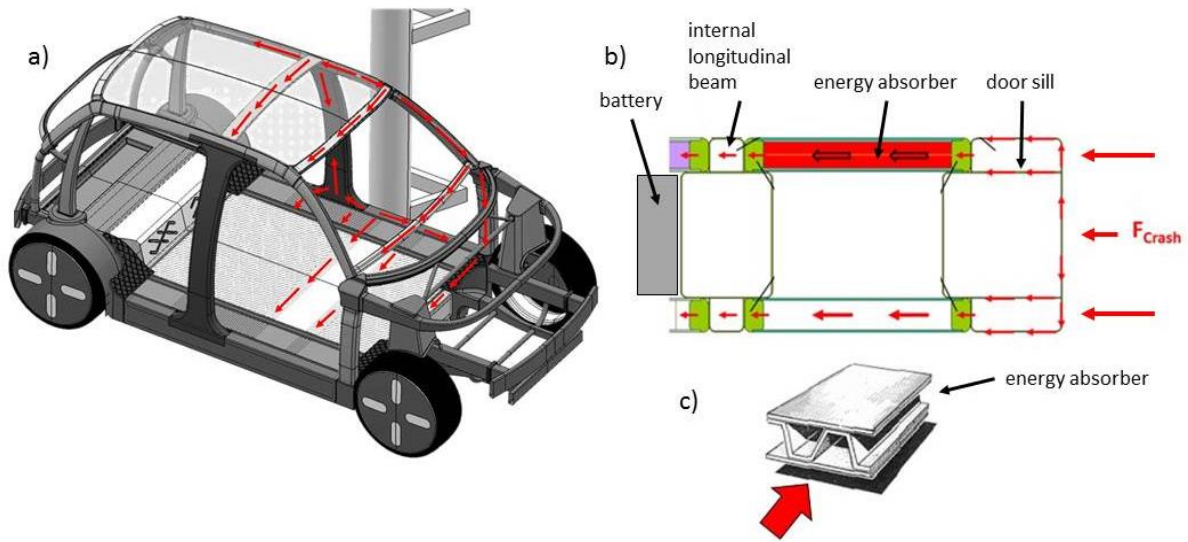

Fig.4: a): Load path during pole crash; b): Cross section through door sill and sandwich crash absorber; c): one possible sandwich crash absorber with trapezoidal core.

**Step 3:**

Taking into consideration the requirements of step 1, particularly those related to modularity, and the considerations of step 2, a body concept for the UMV was developed in step 3 based on the method developed by Münster [4], which serves as a basis for all subsequent steps. The body is a combination of a space frame and sandwich structure. Another feature is the double floor, as well as the crash elements within the door sill area for the side pole crash. [1]

**Step 4:**

Given that the crash concept will be carried out using a pure aluminium construction, tests to produce a material card are indispensable for calculations and subsequent optimisations. To simplify the process, the production of the model and material cards is automated using Python scripts. This allows to quickly extract the material parameters for the simulation, and is very useful for the definition of the material card.

**Step 5:**

Before optimising the individual parameters of the concept, it is necessary to verify that the principle behind the underlying energy absorption mechanism works properly and that the concept meets the necessary requirements. For this, real components are built and a pressure test is carried out. The chosen sandwich core, which consists of a trapezoidal aluminium sheet, is attached to the aluminium face sheets with a structural adhesive (Fig. 5).

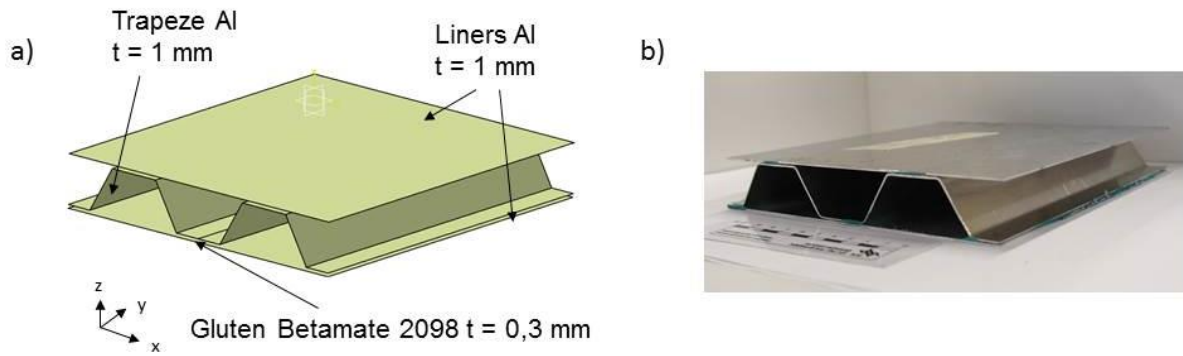

Fig.5: a): Trapezoidal sandwich absorber CAD model; b): Trapezoidal sandwich absorber as a real prototype [1].

**Step 6:**

Once the individual components have been tested, the FE model is validated in the next step. This involves the complete construction of a prototype of the floor crash module and dynamic testing at the dynamic component crash test facility (Fig. 6). This test is used to validate the FE model. The following steps involve the optimisation of the individual components and parameters of the model that has been verified.

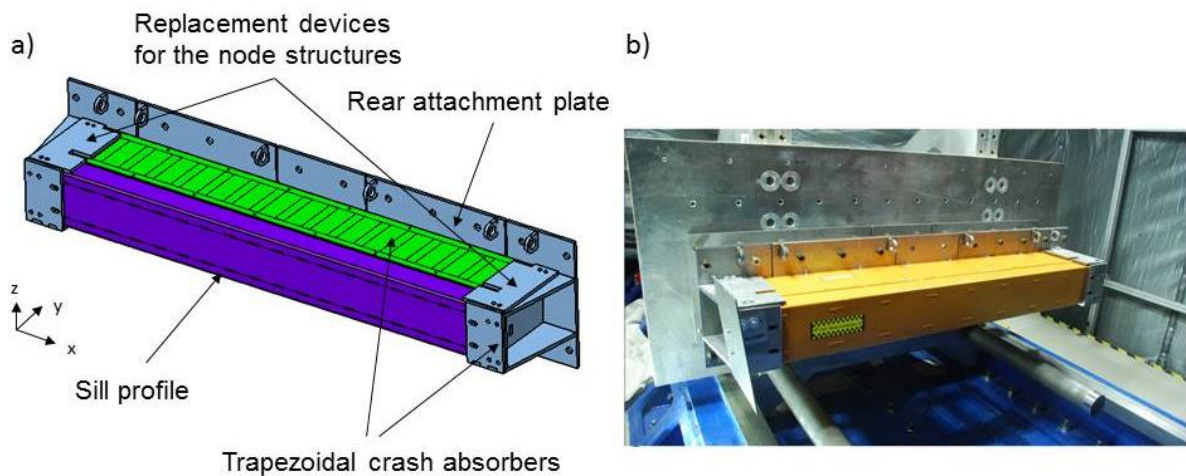

Fig.6: a): CAD model of the UMV floor module crash concept set-up; b): Real test set-up of the floor module. [1]

**Step 7:**

When optimising the shape of the sandwich element (step 7 in Fig. 2), ‘morphing’ produces various geometrics. This involves changes to the angle and height (Fig. 7) of the sandwich core that, with this type of model modification, is carried out with acceptable levels of mesh distortion. To ensure optimal energy absorption, both the geometric variations of the crash absorber, as well as the plate thickness of the face sheets and the core, are modified. As demonstrated in step 2, the energy absorption mechanism, a buckling of the sandwich core, is supported by the face sheets.

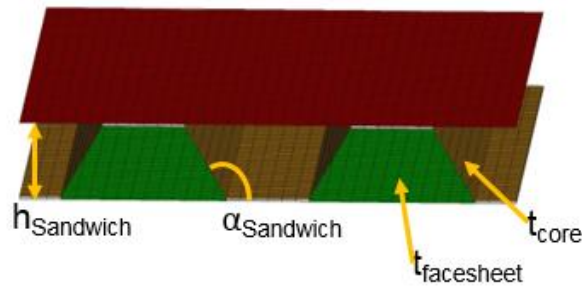

Fig.7: Optimisation parameters of the energy sandwich absorber. [3]

**Step 8:**

The following geometric optimisation of the shape of the door sill (step 8 of Fig. 2) is shown in an outer loop (Fig. 8), which carries out the variation in the internal supporting structures (e.g. the retraction of additional structures), and an inner loop for the optimisation of the internal structure (wall thickness and distance between the structures).

A parametric geometric model is produced with ANSYS APDL within the inner loop, and the structure is automated with Python in a process chain (see Fig. 8 'Inner Loop'). The simulations and optimisations are carried out with the LSTC products LS-DYNA and LS-OPT.

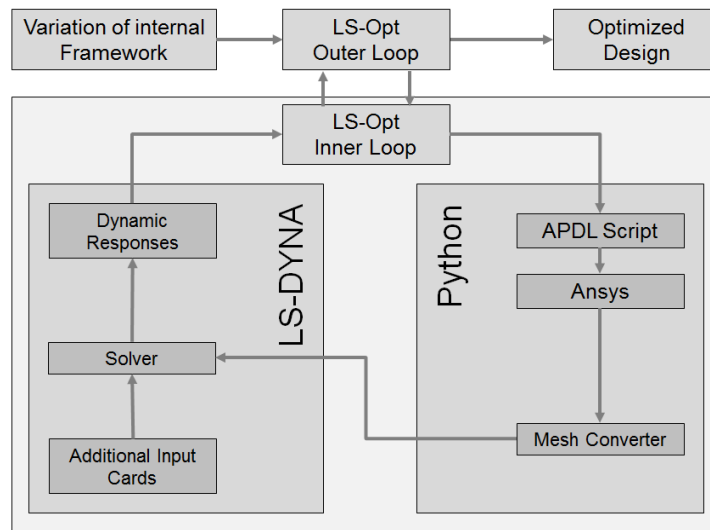

Fig.8: Multi-level optimisation loop for the geometric optimisation of the door sill profile

Optimisation consists of a multi-level optimisation process because it is a discrete optimisation problem. It is not only the positioning of the structures and wall strengths that are optimised, but there is also a variation of the internal supporting structures (Fig. 9). These structures differ from each other such that a continuous optimisation problem can no longer be assumed. There are also other internal structures possible such as foam or honeycombs.

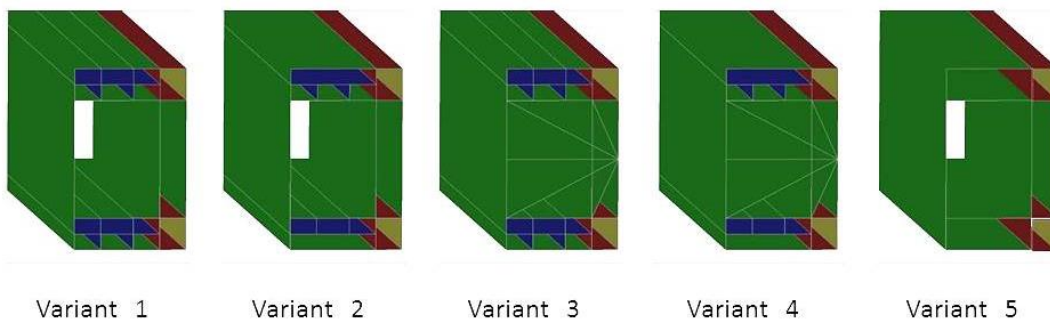

Fig.9: Different internal structures of the door sill, which will be varied during optimisation. [3]

Only one optimisation of the door sill is insufficient because the deformation behaviour of the structure behind it (the crash absorber) must also be taken into consideration. A considerable amount of computing time would be required to simulate the entire floor module. The model must therefore be simplified enough so that optimisation can be performed with acceptable levels of accuracy and in the shortest possible amount of time (98% reduction when compared to the full-vehicle simulation<sup>1</sup>). This is carried out with the following elements: **ELEMENT\_BEAM** and the material model **MAT\_GENERAL\_NONLINEAR\_6DOF\_DISCRETE\_BEAM**, which includes the optimised force-path characteristic from the previous absorber optimisation (step 7 in Fig. 2). This modelling can be seen in Fig. 10. Here, the crash element mentioned in step 5 and 7 is being shown with 3 beams. This ensures that the door sill can undergo a local bend deformation.

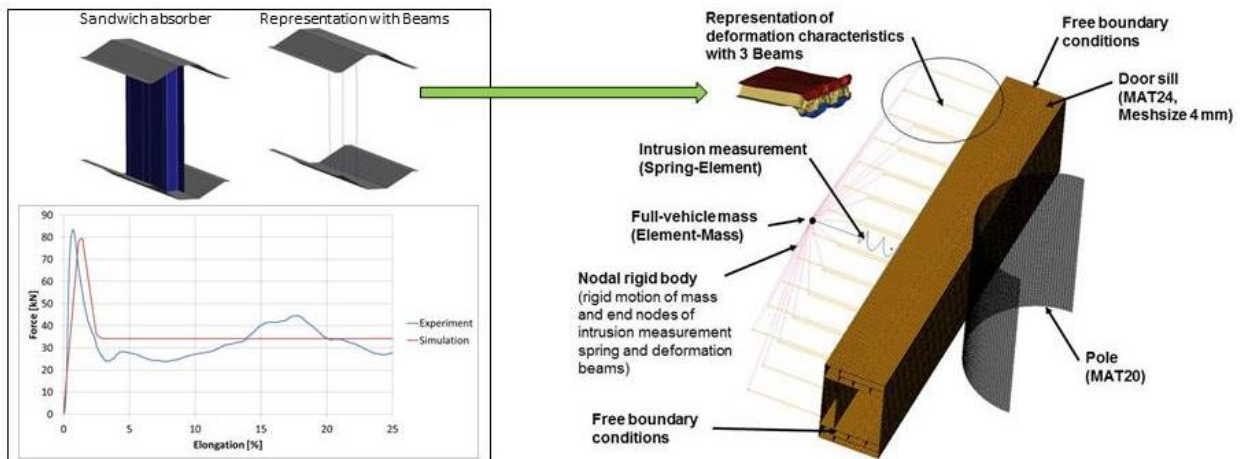

Fig.10: Description of reduced door sill and sandwich crash absorber model.

An **ELEMENT\_DISCRETE** is integrated into the model for measuring intrusion so that each of the design proposals can be assessed. [5]

### Step 9:

Finally, the optimised design proposal must be verified during a full-vehicle simulation. This ensures that the model simplifications that have occurred are assessed and evaluated for each of the individual optimisation steps.

## 3 Results of the optimisation steps

This section will explore steps 5-9 in greater detail. Please refer to [1], [2] and [4] for detailed descriptions of steps 1-3.

### Step 4:

For a detailed and realistic prediction of the structures under a crash load, it is essential to carry out initial material tests. These tests enable behaviour predictions to be carried out by means of structure simulations, as well as optimisation of the structure behaviour, which takes place in the following step. To this end, the material behaviour of the 5xxx series aluminium used is illustrated as accurately as possible. One of the many tests carried out, the unidirectional tensile test, can be seen in Fig. 2, step 4.

### Step 5:

The comparison between the simulation and the test (sandwich made of 5xxx series aluminium) in the force-displacement diagram (Fig. 11) shows a good level of correlation. Both the force peak and plateau can be seen with the FE model. The relatively high peak force could be reduced with different trigger mechanisms.

<sup>1</sup> Intel Xeon E3-1275, 3.5 GHz, 32 GB RAM, LS-DYNA: 4 CPU

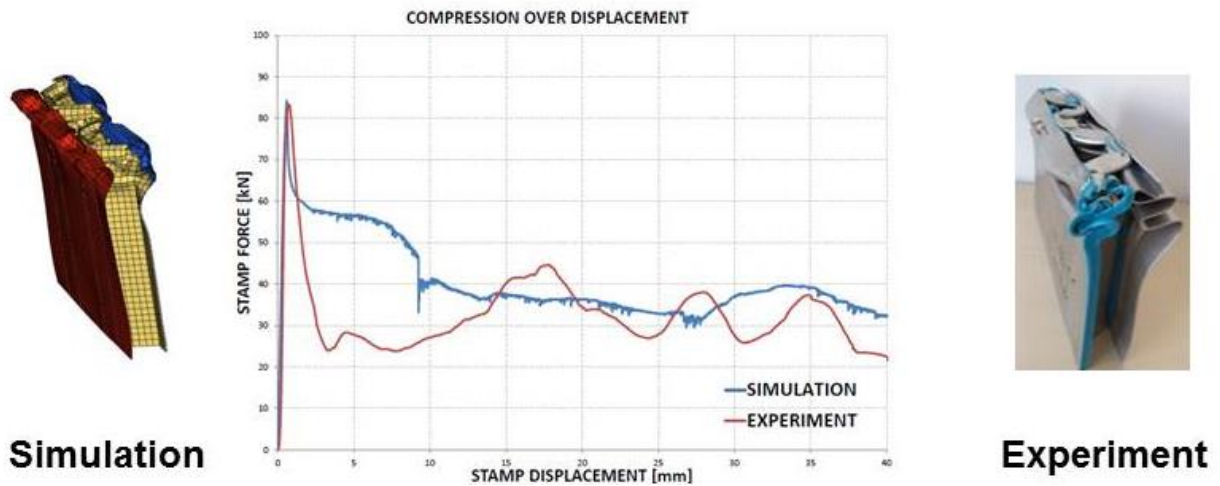

Fig.11: Force-displacement diagram of the simulation and test of a trapezoidal absorber. [1]

In addition to the tests shown in Fig. 11, which only relate to the sandwich absorber, tests are also carried out here on the sandwich absorbers with edge profiles. This is so that a realistic depiction of the deformation mechanisms within the energy absorption concept can be obtained. [1]

**Step 6:**

When validating the entire floor module, a prototype is tested at a dynamic component crash test facility, where an impact mass of 750kg is used in a side door crash (Euro NCAP pole crash), propelled at a speed of 29km/h. When comparing the simulation and the test, the deformation image shows a good degree of correlation (Fig. 12). [1]

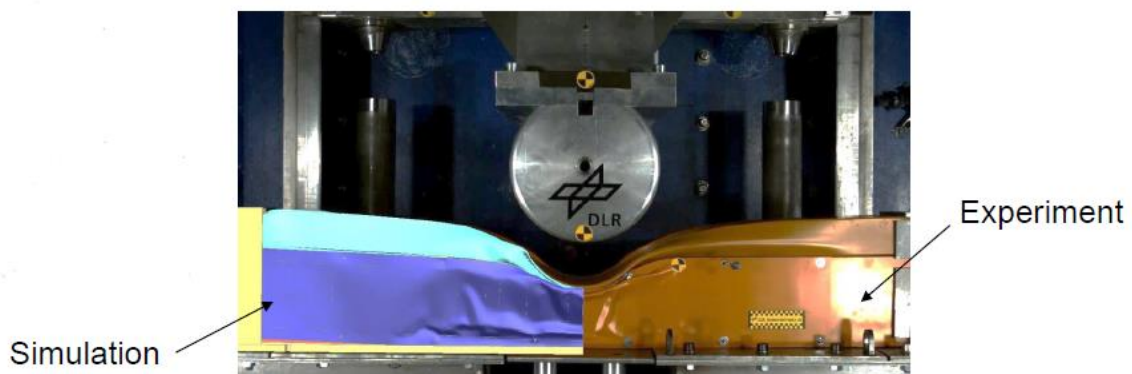

Fig.12: Deformation of the simulation and test of the floor crash concept. [1]

**Step 7:**

Once the simulation model in step 5 has been validated, this next step uses a Design of Experiments (DoE) to determine, first and foremost, the main influential parameters (see Fig. 7) on efficiency (the ration between the peak and plateau forces) and on the specific energy absorption of the sandwich absorber. [5] Following this, adjustments can be made to the parameters identified previously so that absorption behaviour can be optimised.

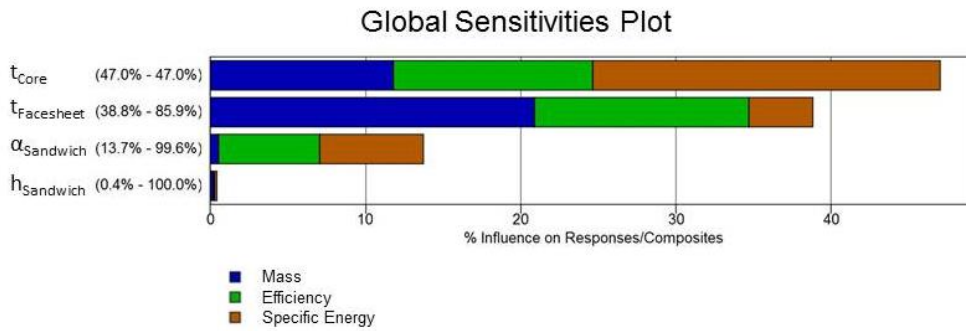

Fig. 13: Global Sensitivities Plot with percentage Influence on Responses.

Varying the parameters shown in Fig. 7 has shown that the thickness of the trapezoidal core has an important influence on specific energy absorption. A change in both the thickness of the face sheets and in the trapezoidal core has a significant influence on the mass. To improve the specific energy without increasing the mass, changes can be made to the trapezoid angle. Since the angle of the trapezoid has no effect on the mass, yet a significant one on the specific energy, these parameters have the potential to increase the specific energy whilst maintaining the mass. The efficiency of the crash absorber is largely influenced by both the thickness of the face sheets as well as the trapezoidal core. As such, this influence shall be illustrated further in Fig. 14.

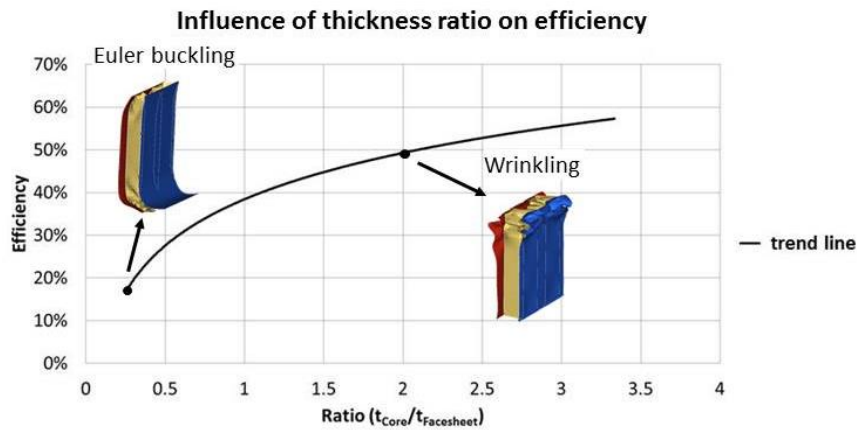

Fig. 14: Influence of thickness ratio on efficiency of the sandwich absorber.

To illustrate the influence that both sheet plates have on the level of efficiency, the ratio ( $\eta = t_{Core} / t_{Facesheet}$ ) has been used on both parameters. This ratio has a large influence on the failure behaviour of the sandwich absorber. A small ration will lead to a global Euler buckling. But if the ratio is large, the curve will be stable, which is preferred in terms of high-energy absorption and a high level of efficiency (see Fig. 14).



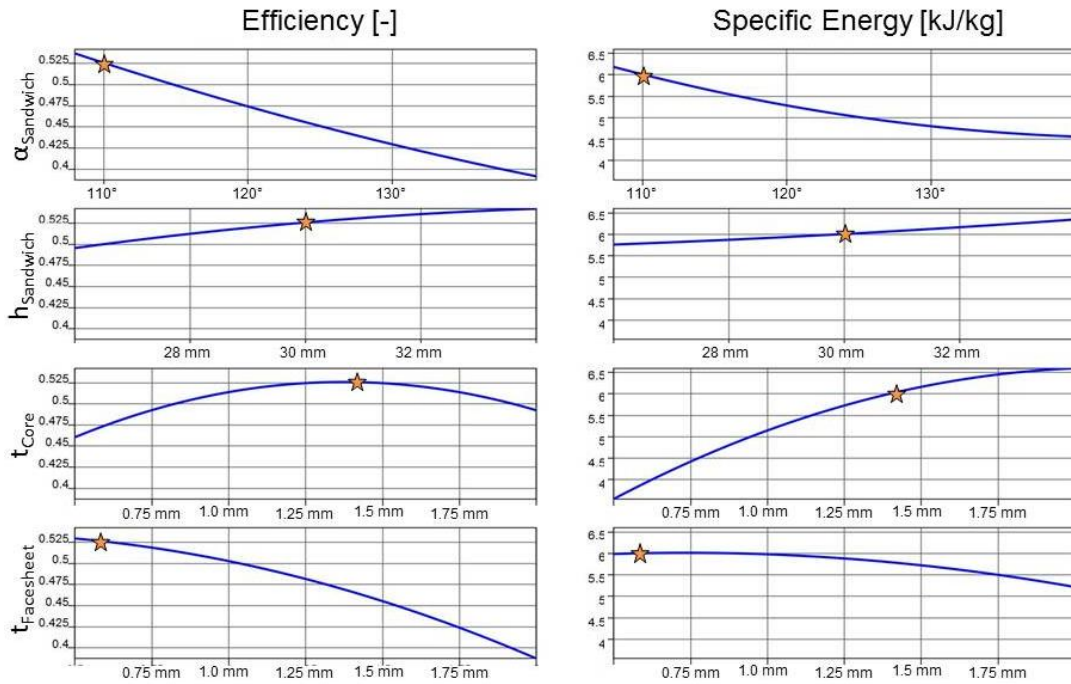

Fig. 15: DoE results of the sandwich crash absorber by varying angle, height and thickness of the core and face sheets.

The ideal combination for reaching a high level of efficiency whilst also achieving high specific energy absorption is shown in Fig. 15.

It is worth pointing out here that the height of the sandwich only has a small influence. A smaller angle (~110°) here has the advantage that more edges that can be achieved during the buckling of deformation energy. Furthermore, it has been shown that the optimal thickness of the trapezoidal core is 1.4mm, based on the level of efficiency. A greater thickness must be chosen for the plates used for the face sheets because energy absorption takes place primarily in the sandwich core, and the face sheets serve mainly to stabilise the core during energy conversion.

#### Step 8:

Once an optimal parameter combination has been found for the sandwich absorber, all that remains is to implement this to the door sill structure. As described in the previous section, the optimised sandwich absorber is also taken into consideration at this point.

The result of the multi-layer optimisation of the variants shown in Fig. 9 can be seen in Fig. 16. This relates to finding a reasonable compromise between the mass of the structure and the specific energy absorption, whilst also taking intrusion into account. Consideration for intrusion is an evaluation criterion here, because this ensures survival space for passengers in the event of a crash.

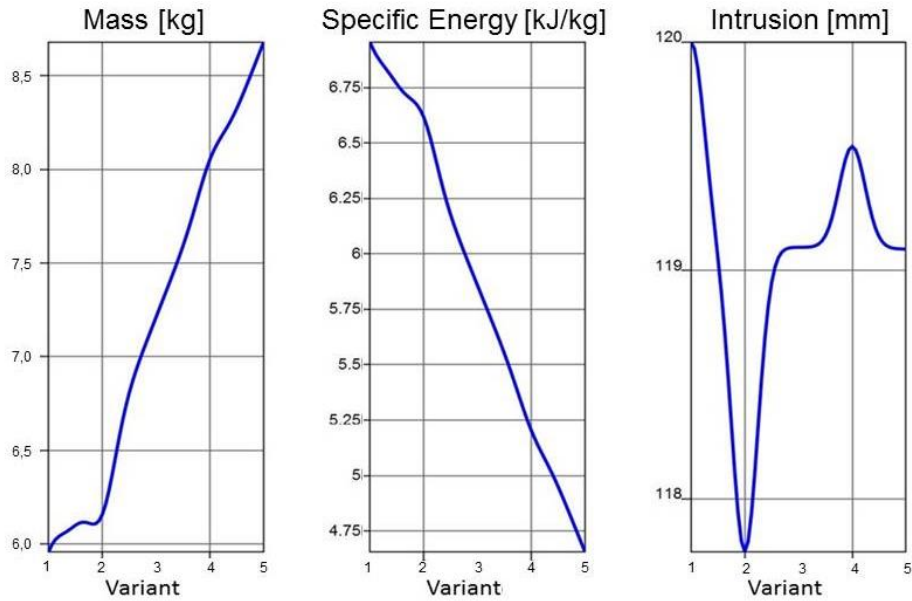

Fig. 16: Results of multi-level-optimisation of the internal structures of the door sill.

In this case, Variant 2 offers the best compromise. On the one hand, Variant 2 provides a high specific energy absorption, but on the other hand, it has the lowest intrusion of all optimised variants. Given these results, placing a stiffening structure (Fig. 17 a)) inside the door sill is only logical.

Fig. 17 b) shows the deformed structure. Both the door sill structure and the crash absorber behind it (shown in the analogical models) convert the kinetic energy into deformation work and, therefore, contribute to the crash safety of the entire structure.

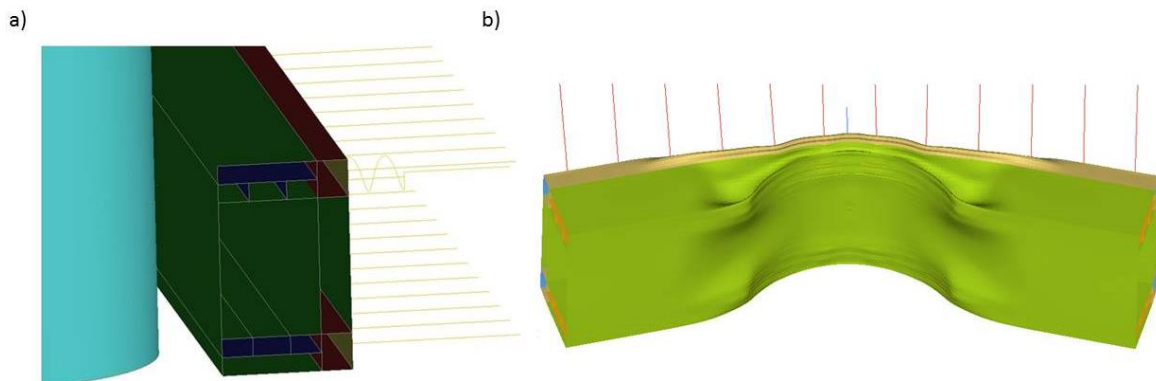

Fig. 17: a): Optimised internal structure of door sill from the multi-level-optimisation; b): Deformed door sill with sandwich crash absorber after pole crash.

#### Step 9:

Finally, a simulation of the entire vehicle is needed in order to verify the optimisation results and the analogical modelling. Fig. 18 shows the results of this simulation. Both the door sill structure and the sandwich crash absorber behind it deform in the same way as the analogical model and in so doing, ensure the survival space for passengers and prevent intrusion into the battery, which is located behind in the double floor. Compared to the non-optimised version, energy absorption was improved by ~24% and intrusion by ~30%.

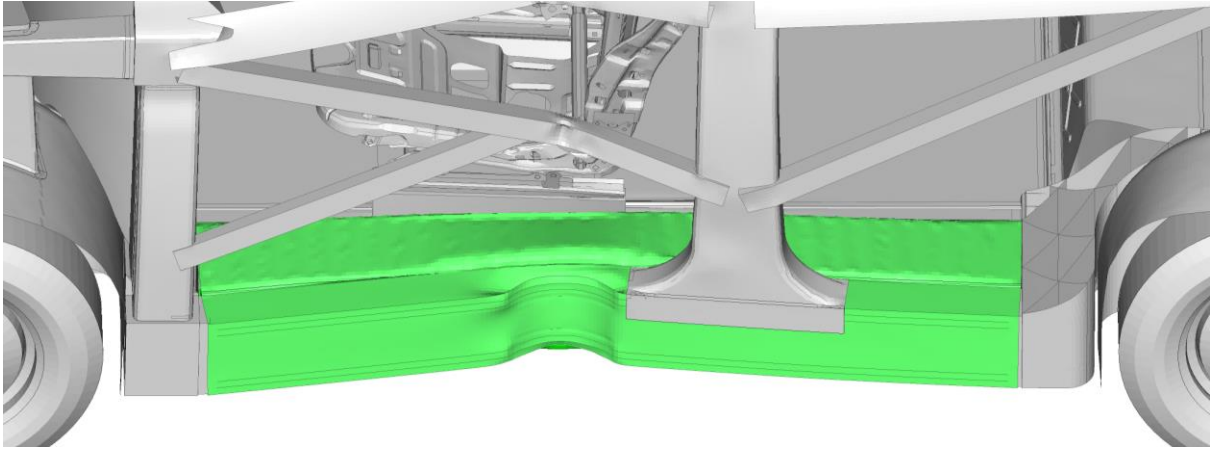

Fig.18: Deformed structure in full-vehicle crash after pole impact.

#### 4 Conclusion

A methodological approach to the development of an optimised side crash concept for the battery-electric vehicle concept Urban Modular Vehicle was presented in order to meet the requirements of a fully functional concept. In addition to the load path analyses shown, and the subsequent energy absorption process, validation tests at a coupon and component level, as well as the optimisation models validated alongside these, have been demonstrated.

To optimise the sandwich crash concept, the 'morphing' method was used to modify the geometry. This allows the main influential factors for energy absorption to be identified due to the buckling of the sandwich core, as well as allowing the determination of an optimal combination of the parameters being tested.

One sole optimisation of the door sill structure was shown to be impractical, which led to the development of an analogical modelling, which yielded acceptable levels of accuracy (2.5% deviation for intrusion when compared to the full-vehicle simulation; see Fig. 19) and the best possible reduction in time (98% reduction when compared to the full-vehicle simulation<sup>2</sup>) to be achieved when optimising the internal structures of the door sill. The analogical model shows, above all else and with sufficient accuracy, the important area of deformation at the point of impact of the pole. The model also shows weaknesses in the free ends of the edge areas, which is of little importance here. Given that the variation in the door sill structure is equal to that of a discrete optimisation problem, a multi-level optimisation was used. The advantage of this is that each variant is optimised and then later compared with the discrete variants. One final check is made in the full-vehicle crash model in order to verify both the optimisation results and the analogical model. Furthermore, optimisation steps 7 and 8 improve the specific energy absorption by ~24%, and the intrusion by ~30%.

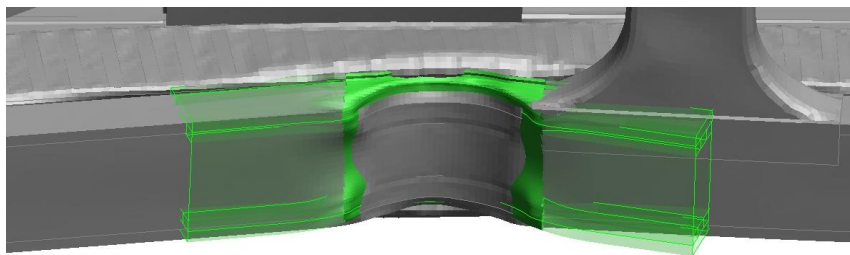

Fig.19: Comparison of full-vehicle crash and Submodel after pole impact.

The future goal is to detail the UMV body even further, as well as to use and detail the analogous model and optimisation approaches developed for different applications. In addition, it is planned to carry out the more complicated geometric changes in CAD systems, which will enable the optimisation process chain used to be extended to the system interfaces, thus guaranteeing an automated optimisation process. In order to improve accuracy in the edge areas of the analogical model for the optimisation of the door sill structure, whilst also taking into consideration the underlying crash

<sup>2</sup> Intel Xeon E3-1275, 3.5 GHz, 32 GB RAM, LS-DYNA: 4 CPU

elements, in addition to the rest of the body structure, the modelling methods of [6] can be used, as this takes the specific forces and degrees of freedom of the planes into consideration.

## 5 Literature

- [1] Münster, M.; Schäffer, M.; Sturm, R.; Friedrich, H.E.: "Methodological development from vehicle concept to modular body structure for the DLR NGC-Urban Modular Vehicle, 16<sup>th</sup> Stuttgart International Symposium, Stuttgart, Germany, 2016
- [2] Kopp, Gu.; Kopp, Ge.; Münster, M.; Kriescher, M.; Friedrich, H.E.: "Next Generation Car – Function Integrated Lightweight Structures", strategies for car body construction, Bad Nauheim, Germany, 2016
- [3] Schäffer, M.; Münster, M.; Sturm, R.; Friedrich, H.E.: "Optimization of energy absorber for a novel electric vehicle concept", 9<sup>th</sup> Graz Symposium Virtual Vehicle, Graz, Austria, 2016
- [4] Münster, M.; Schäffer, M.; Kopp, Ge.; Kopp, Gu.; Friedrich, H.E.: "New approach for a comprehensive method for urban vehicle concepts with electric powertrain and their necessary vehicle structures", 6<sup>th</sup> Transport Research Arena, Warsaw, Poland, 2016
- [5] Prem, A.; Bastien, C.; Dickison, M.: "Multidisciplinary Design Optimisation Strategies for Lightweight Vehicle Structures", 10<sup>th</sup> European LS-DYNA Conference, Würzburg, Germany, 2015
- [6] Straßburger, P.; Beeh, E.; Friedrich, H.E.: "Novel procedure model for an improved comparison of simulation and component crash test results", automotive CAE Grand Challenge, Hanau, Germany, 2016