

eta/Post

User's Manual

Version 1.2.10 (Build 2006-06-02)

Engineering Technology Associates, Inc.

1133 E. Maple Road, Suite 200

Troy, MI 48083-2896

Phone: (248) 729-3010

Fax: (248) 729-3020

Support: (800) 382-3362

E-mail: support@eta.com

Engineering Technology Associates, Inc., ETA, the ETA logo, and eta/Post are the registered trademarks of Engineering Technology Associates, Inc. All other trademarks or names are the property of the respective owners.

Copyright 1998 to 2006 Engineering Technology Associates, Inc. All rights reserved.

TABLE OF CONTENTS

TABLE OF CONTENTS	III
TABLE OF FIGURE	VII
INTRODUCTION	1
1. STRUCTURAL OVERVIEW	3
1.1. GENERAL OVERVIEW.....	3
1.2. MENU BAR	4
1.3. ICON BAR	5
1.4. DISPLAY OPTIONS.....	13
1.5. PRIORITY OF FUNCTIONS.....	15
1.6. CONTROL WINDOW AND CONTROL OPTION	15
1.7. FILE FORMAT	15
1.8. CONFIGURATION FILE	16
2. GETTING STARTED	19
2.1. GETTING STARTED WITH D3PLOT FILE.....	19
2.2. INDEX File.....	20
2.3. REQUIREMENTS.....	21
3. FILE MENU	23
3.1. OPEN.....	23
3.2. IMPORT	24
3.3. EXPORT.....	24
3.4. COPY TO CLIPBOARD.....	25
3.5. PRINT.....	25
3.6. PRINT TO FILE	28
3.7. QUIT (ALT+Q)	29
4. EDIT MENU.....	31
4.1. CREATE LINE.....	31
4.2. DELETE LINE	32
4.3. LABEL/ARROW.....	32
4.4. ROTATE LIGHT.....	34
4.5. LIGHT PROPERTY	34
4.6. COLOR MAP	36
4.7. PART ATTRIBUTES.....	37
4.8. USER VIEW.....	43
4.9. BACKGROUND COLOR.....	44
5. TOOL.....	47
5.1. SECTION CUT.....	47
5.1.1. DEFINE CUT PLANE.....	48

5.1.2. CLEAR SECTION CUT	50
5.1.3. NORMAL VIEW	50
5.1.4. SECTION CUT OPTIONS	50
5.1.5. EXPORT SECTION CUT	52
5.1.6. SECTION VALUE CURVE.....	53
5.1.7. SECTION CURVATURE CURVE	54
5.1.8. MEASURE ARC LENGTH	55
5.1.9. MOVE SECTION BY MOUSE.....	56
5.1.10. DISPLAY OPTIONS	56
5.1.11. SECTION LINE POSITION.....	57
5.2. CONSTRAINT MOTION	58
5.3. MIRROR RESULT BY XYZ.....	58
5.4. FACE REFLECTION LINE CHECK	60
5.5. DEFINE ACTIVE WINDOW	63
5.6. DEFINE NODE TRACE	64
5.7. PART VALUE CURVE	65
5.8. NODAL VALUE CURVE.....	66
5.9. ELEMENT VALUE CURVE.....	67
5.10. NODAL DISPLACEMENT CURVE.....	68
5.11. PART DISTANCE.....	69
5.12. PART INTERFERENCE CHECK	71
5.13. EXPORT BOUNDARY LINE	73
5.14. MODEL SUMMARY	73
6. OPTION	75
6.1. AXIS (toggle)	75
6.2. TITLE (toggle).....	75
6.3. COLOR BAR(toggle).....	75
6.4. MAX-MIN MARKER (toggle)	76
6.5. LOGO	76
6.6. NORMAL COLOR (toggle)	76
6.7. ELEMENT ORIENTATION (toggle)	76
6.8. ACTIVE CONTOUR RANGE	77
6.9. OVERALL CONTOUR RANGE.....	77
6.10. DEFINE ROTATE CENTER	77
6.11. APPLY VPG LAYOUT.....	77
6.12. APPLY SECOND SHADING	78
6.13. APPLY FADED BACKGROUND.....	78
6.14. APPLY LOCAL LIGHT.....	78
6.15. APPLY MOUSE TRACKING	78
7. POSTPROCESS.....	79
7.1. UNDEFORM	80
7.2. DEFORM.....	80
7.2.1. DEFORM OPERATION	80

7.2.2. FRAME OPERATION	81
7.2.3. ANIMATION OPERATION	82
7.3. CONTOUR	84
7.3.1. SELECT COMPONENT	85
7.3.2. CURRENT LAYER.....	86
7.3.3. INCREMENT	86
7.3.4. UNDEFORM	87
7.3.5. ELEMENT RESULT	88
7.3.6. CONTOUR SETTING.....	88
7.3.7. EXPORT CONTOUR LINE.....	90
7.3.8. LIST VALUE.....	91
7.4. VECTOR	93
7.4.1. SELECT COMPONENT	94
7.4.2. BY ELEMENT SIZE AND SCALE FACTOR	95
7.5. FLD.....	96
7.5.1. FLD CURVE OPTION	97
7.5.2. EDIT FLD WINDOW.....	100
7.5.3. FLD REVERSED MAPPING.....	100
7.5.4. FLD PATH.....	101
7.6. THICKNESS	101
7.7. MAJOR AND MINOR STRAIN.....	104
7.8. IN PLANE STRAINS.....	104
7.9. BLANK TOOL DISTANCE	105
7.10. CIRCULAR GRID.....	108
7.11. SKID MARK	110
7.12. BLANK OUTLINE	112
7.13. EDGE MOVEMENT.....	114
7.14. DEFECT DETECTION	116
7.15. BLANK MOVEMENT.....	120
8. GRAPH.....	123
8.1. START UP.....	123
8.2. RESULT FILE LOAD.....	124
8.2.1. AIRBAG STATISTICS (ABSTAT)	126
8.2.2. BOUNDARY NODAL FORCES (BNDOUT)	126
8.2.3. DEFORMED GEOMETRY (DEFGEO)	126
8.2.4. DISCRETE ELEMENTS (DEFORC).....	126
8.2.5. ELEMENT DATA (ELOUT)	127
8.2.6. CONTACT ELEMENT RESULTANTS (GCEOUT)	127
8.2.7. GLOBAL DATA (GLSTAT).....	127
8.2.8. JOINT FORCE FILE (JNTFORC)	128
8.2.9. MATERIAL EERGIES (MATSUM).....	128
8.2.10. CONTACT INTERFACE FORCES (NCFORC).....	128
8.2.11. NODAL FORCE (NODFOR).....	129
8.2.12. NODAL POINT DATA (NODOUT).....	129

8.2.13. RIGID BODY DATA (RBDOUT)	129
8.2.14. RESULT INTERFACE FORCES (RCFORC)	130
8.2.15. WALL FORCES (RWFORC).....	130
8.2.16. SEATBELT OUTPUT (SBTOUT)	130
8.2.17. CROSS SECTION FORCE (SECFORC)	130
8.2.18. SLIDING INTERFACE ENERGY (SLEOUT).....	131
8.2.19. SPC REACTION FORCES (SPCFORC)	131
8.2.20. SUBSYSTEM STATISTICS (SSSTAT)	131
8.2.21. SPOTWELD RIVET FORCES (SWFORC).....	132
8.2.22. TEMPERATURE OUTPUT (TPRINT)	132
8.3. Graph Control Window.....	132
8.4. Graph Operation.....	135
8.4.1. PRINT	135
8.4.2. CLIPBOARD	135
8.4.3. EXPORT	136
8.4.4. ATTRIBUTE	136
8.4.5. OPERATION.....	140
8.4.6. SAVE.....	150
INDEX FILE FORMAT	151
INTRODUCTION	151
HEADER	151
*DATABASE_FILE.....	151
*DATABASE_STATISTICS	152
*DATABASE_UNIT.....	152
*PART_DF	153
*DEFINE_FLD.....	153
*DRAWBEAD_DF	154
*DEFINE_POPLINE.....	155
*DEFINE_LINE3D	155
*END.....	156
HARDWARE AND SOFTWARE REQUIREMENTS.....	157
FINAL NOTES	159

TABLE OF FIGURE

Figure 1.1 eta/Post interface window	3
Figure 1.2 PART ON/OFF window	6
Figure 1.3 Identify Node Control Option window	11
Figure 1.4 Measure distance Control Option window	12
Figure 1.5 Post process functional icons in icon bar	13
Figure 1.6 Special icons for eta/DYNAFORM result	13
Figure 2.1 eta/Post GUI.....	19
Figure 2.2 Select File window	20
Figure 2.3 Select idx File Window	21
Figure 3.1 The file menu	23
Figure 3.2 Select File window	23
Figure 3.3 Import File window	24
Figure 3.4 Export file dialog box	25
Figure 3.5 Print window.....	26
Figure 3.6 Select Print Area Dialogue Box	28
Figure 3.7 Print to File Window.....	29
Figure 4.1 Edit menu.....	31
Figure 4.2 Create Line Control Option window	31
Figure 4.3 Label and Arrow Control Option Window.....	33
Figure 4.4 Light Property Control Option Window	34
Figure 4.5 Light Adjustment Control Window.....	36
Figure 4.6 Color Map Control window.....	37
Figure 4.7 Part Color Control window.....	37
Figure 4.8 Part Attributes control window (Part Colour).....	38
Figure 4.9 Part Attributes control window (Part Material)	39
Figure 4.10 Part Attributes control window (Transparency).....	40
Figure 4.11 Part Attributes control window (Wire Frame).....	41
Figure 4.12 Part Attributes control window (No Contour)	42
Figure 4.13 User View control window	43
Figure 4.14 View Name control window	44
Figure 4.15 Background Color Palette.....	45
Figure 5.1 Tool Menu.....	47
Figure 5.2 Section Cut Operation.....	48
Figure 5.3 Define Cut Plane.....	49
Figure 5.4 Section Cut Operation.....	50
Figure 5.5 Section Cut Option	51
Figure 5.6 The result of ARC FIT	52
Figure 5.7 Export Nastran File	53
Figure 5.8 A Section plus curve window.....	54
Figure 5.9 Section Curvature Curve.....	55
Figure 5.10 Measure Arc Length	55
Figure 5.11 An Example for PARTIAL MODEL display	57
Figure 5.12 Constraint Motion Dialog Window.....	58
Figure 5.13 Constraint Motion Dialog Window.....	58
Figure 5.14 Mirror Result Control Option Window.....	59
Figure 5.15 Example of a quarter model and result	59
Figure 5.16 Mirrored model and result by YZ Plane	60
Figure 5.17 Face Reflection Control Window	61
Figure 5.18 Face Reflect Examination Result.....	62

Figure 5.19 Define Active Window Control Window	63
Figure 5.20 Select Node Control Window	64
Figure 5.21 The Node Trace.....	64
Figure 5.22 Select Part Control Option.....	65
Figure 5.23 A typical Part value curve	66
Figure 5.24 Select Node Control Window	66
Figure 5.25 Node Curve Result.....	67
Figure 5.26 A sample of ELEMENT VALUE CURVE.....	68
Figure 5.27 User Select Control Window	68
Figure 5.28 Nodal Displacement Curve Example.....	69
Figure 5.29 User Control Window	69
Figure 5.30 Calculation Result When the Option is off	71
Figure 5.31 Calculation Result when the Option is on.....	71
Figure 5.32 User Control Window	72
Figure 5.33 Export Boundary Line dialog window.....	73
Figure 5.34 Model Summary	74
Figure 6.1 Tool Menu.....	75
Figure 6.2 Typical display with Normal Color and Plate Normal option.....	76
Figure 6.3 Typical display with Element Orientation option	77
Figure 7.1 Post-process functional icons.....	79
Figure 7.2 Deform control window.....	80
Figure 7.3 Frames Operations	81
Figure 7.4 Animate.....	82
Figure 7.5 Play Status	83
Figure 7.6 Pause Status	83
Figure 7.7 Animate Contour control window.....	85
Figure 7.8 Contour display on un-deformed mesh.....	87
Figure 7.9 Contour display on deformed mesh	87
Figure 7.10 Contour Setting box.....	88
Figure 7.11 The Reverse contour Bar result.....	88
Figure 7.12 A typical contour plot with Contour Range	89
Figure 7.13 An Example for Contour plot of 12 colors.....	90
Figure 7.14 Select Node Control Option.....	91
Figure 7.15 List Node Value	92
Figure 7.16 List Value Control Option.....	92
Figure 7.17 Vector Operation control window	94
Figure 7.18 FLD control window.....	96
Figure 7.19 FLD Curve and Option	97
Figure 7.20 FLD file format.....	98
Figure 7.21 An Example of FLD evaluation.....	100
Figure 7.22 FLD Strain Path	101
Figure 7.23 Thickness Control Window.....	102
Figure 7.24 Thickness Contour	103
Figure 7.25 Thinning Contour.....	103
Figure 7.26 Major Strain and Minor Strain	104
Figure 7.27 Strain In-Plane Control Window.....	105
Figure 7.28 Blank Tool Distance.....	106
Figure 7.29 Select Part Control Option.....	107
Figure 7.30 Blank and Tool Distance	108
Figure 7.31 Circular Grid.....	109
Figure 7.32 A sample plot of Circular Grid.....	110
Figure 7.33 Skid Mark Operation	111
Figure 7.34 A sample plot of Skid Mark	112
Figure 7.35 Select Line Control Option Window.....	113

Figure 7.36 Trim Line on Final Step of the Deformed Blank	113
Figure 7.37 Outline on the Undeformed blank	113
Figure 7.38 Edge movement control window	114
Figure 7.39 Material Float Define.....	115
Figure 7.40 X Displacement is 20, the material movement	115
Figure 7.41 Defect Detection	117
Figure 7.42 Select Elements Option.....	118
Figure 7.43 Defect Detection	119
Figure 7.44 An Example of Detect Defection	120
Figure 7.45 Blank Distance.....	121
Figure 7.46 Blank Movement Nephogram.....	122
Figure 8.1 Graph start up window.....	124
Figure 8.2 Select File dialog box.	125
Figure 8.3 Graph control window	133
Figure 8.4 Graph window in eta-Post window.	134
Figure 8.5 Curve operation toolbar.	135
Figure 8.6 An inserted image form clipboard to MS-Word.....	136
Figure 8.7 Attribute control window	137
Figure 8.8 Properties window	138
Figure 8.9 Colour panel.....	139
Figure 8.10 Curve Operation window.....	141
Figure 8.11 DATA CONTROL window of AVERAGE filter.....	144
Figure 8.12 DATA CONTROL of FIR filter	145
Figure 8.13 DATA CONTROL window of SAE filter	146
Figure 8.14 DATA CONTROL window of Butterworth filter	147

0

INTRODUCTION

The POST function in DYNAFORM is a general post-processor for all ETA software, including DYNAFORM, VPG, and FEMB. POST is an independent application module that is started when the user selects POST from the top menu.

The POST module quickly post-processes result data of finite element analyses, including the real-time animation of stresses, strain, energy, displacements, and time history curves. Its fully dynamic allocation of memory optimizes system resources, allowing for unlimited model sizes.

1

STRUCTURAL OVERVIEW

1.1. GENERAL OVERVIEW

The POST application interface varies slightly from the preprocessing user interface. It allows the user to quickly access most functions at any time during the session. The icon bar and menu bar functions behave in the same manner as the preprocessing functions.

eta/Post breaks the screen into six distinct regions. The regions are used to provide input or display messages to the user. The six regions are illustrated and described in Figure 1.1.

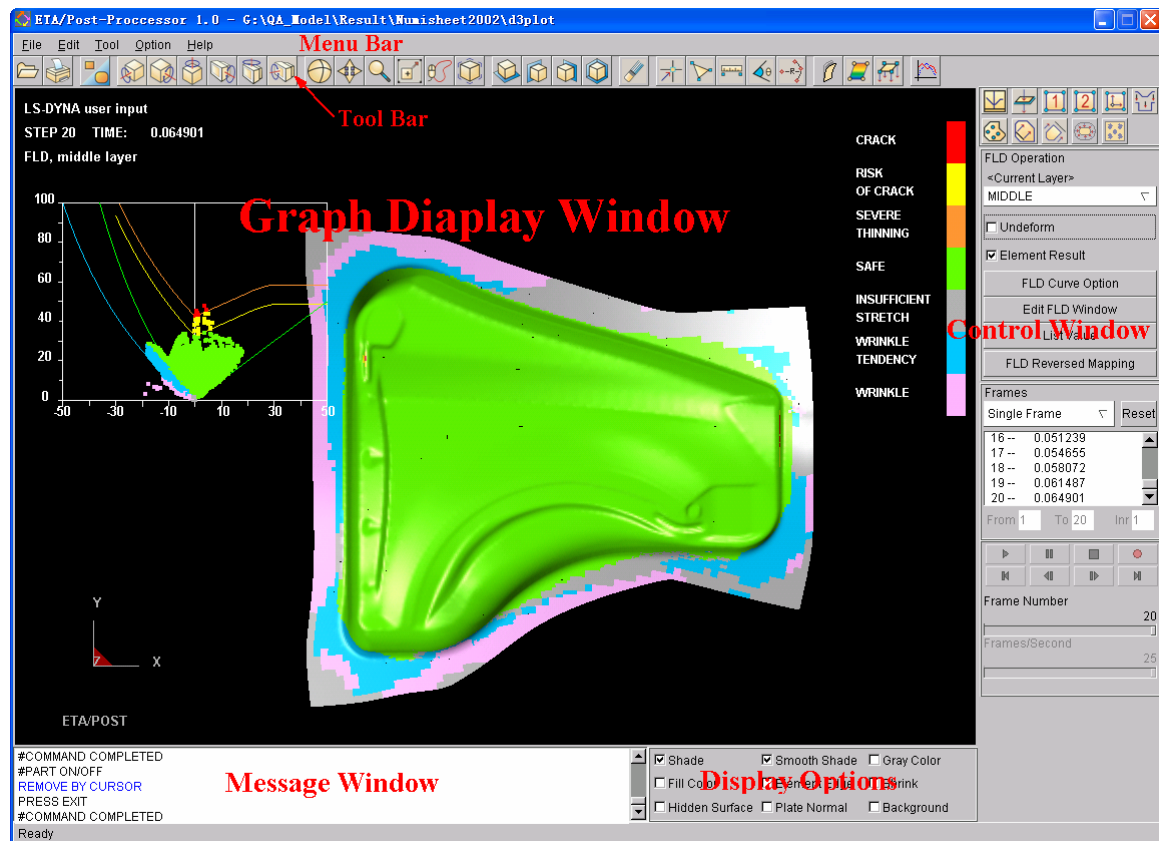

Figure 1.1 eta/Post interface window

1. GRAPHIC DISPLAY WINDOW

Model and graphs are displayed in this window.

2. MENU BAR

Commands and options are displayed in this area.

3. ICON BAR

Gives the user easy access to the commonly used functions of the program.

4. CONTROL WINDOW AREA

Once the user selects a command from the MENU BAR or ICON BAR, a corresponding dialog window with the appropriate functions is displayed in this area.

5. DISPLAY OPTIONS

The options in this group are used to control the model displayed in the graphic display window. These options are always displayed and can be used at any time during an eta/Post session.

6. PROMPT AREA

eta/Post displays comments and messages to the user.

The Graphic User Interface (GUI) is designed for easy access to all the functions for post-processing DYNA and Nastran results. This GUI is unified for both Windows and UNIX/LINUX platforms. The user activates the functions via mouse click.

1.2. MENU BAR

The menu bar contains the FILE, EDIT, TOOL and OPTION menus. All the menus are designed in a logical and efficient way to minimize number of mouse clicks and operations. The FILE menu contains functions that control the input and output of data files, the EDIT menu contains functions that allow the user to alter the model/graph and the VIEW menu contains functions that alter the display. Each of these menus branches into various submenus and functions.

File Edit Tool Option Help	
FILE MANAGER	Imports and exports data from eta/Post
EDIT	Organizes the functions for model operation
TOOLS	eta/Post's "tool kit."
OPTION	Provide options in the graphics display window.
HELP	Displays the information to contact eta/Post Technical Support.

The menus and functions will be described in the related sections.

1.3. ICON BAR

The icon bar is designed to give the user easy access to the most commonly used functions in eta/Post. Some of the functions represented in the icon bar are also located in the different menus. The user may simply click these icons to activate the functions instead of navigating through the menus.



7.  OPEN

Opens a result or model file.

8.  PRINT

Creates a postscript file of the display area and sends it to the printer (default) or writes the image to a file. Prior to printing, the printer must be initialized to accommodate the print out from eta/Post software.

9.  PART ON/OFF

This function enables the user to turn the selected part(s) on/off. Once the function is selected, the PART ON/OFF dialog window is displayed shown as Figure 1.2.

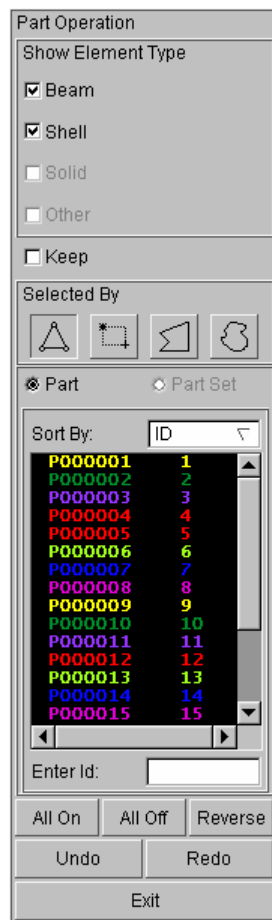

Figure 1.2 PART ON/OFF window

Note: When PART ON/OFF dialog window is displayed, only VIEW OPERATION functions are enabled to use, other functions are disabled.

- Part and part set option

Default setting closes and opens parts. If post process result includes part set define, the option can be activated. At this time, the opening and closing object is part set.

- Sort By

Includes ID and NAME options. Parts can be arranged by selected method in part list.

- Enter ID

User may enter part ID in the input box and then click ENTER to change current real status. If it was open before, it is closed after clicking ENTER, and vice versa.

User can select part to turn on or off by picking the part name in the part list. There are several other methods to turn part on or off as described below.

- SELECT BY

-  PICK ELEMENT

The part including the selected element is selected. The element will be highlighted as the cursor moves over the part.

-  SELECT BY DRAG WINDOW

This function allows the user to drag a window around the desired parts, All parts including the selected elements are selected.

-  SELECT BY MULTI-REGION

This function allows the user to select a multi-point region, all parts including the selected elements are selected. Points are selected by clicking the mouse in the Graphic Display area.

-  SELECT BY FREE HAND

This function allows the user to select a region by a free hand, all parts including the selected elements are selected. The user depresses the left mouse button and moves the mouse to select the desired region.

- SHOW ELEMENT TYPE

This function allows the user to turn selected element types on/off so that they are shown or no longer shown in the window list and in the GRAPHIC DISPLAY window.

- BEAM

All parts with the beam element are removed from the part list if the BEAM is toggled off. And all parts with the beam element appear in the part list if the BEAM is toggled on.

- SHELL

All parts with the shell element are removed from the part list if the SHELL is toggled off. And all parts with the shell element appear in the part list if the SHELL is toggled on.

- SOLID

All parts with the solid element are removed from the part list if the SOLID is toggled off. And all parts with the solid element appear in the part list if the SOLID is toggled on.

- OTHER

All parts with the line are removed from the part list if the OTHER is toggled off. And all parts with the line appear in the part list if the OTHER is toggled on.

- KEEP

If KEEP is selected, the selected parts are highlighted and are labeled with asterisk on the Part List. When the user exits the function, only the selected parts remain displayed.

- ALL ON

Turns all parts on and displays them on the screen.

- ALL OFF

Turns all parts off from the GRAPHICS DISPLAY.

- REVERSE

This function reverses the current on and off status of the parts in the model. The program updates the model display accordingly.

- UNDO

Undo the last operation in Part ON/OFF function.

- REDO

Redo the last operation in the part ON/OFF function.

- EXIT

Closes the PART ON/OFF dialog window and exits the function.

10. VIRTUAL X ROTATION

The displayed model will dynamically rotate about the global X-axis when the cursor is moved up or down. Default rotate center is the model center. If Define Rotate Center is open, user may define rotate center. After clicking the VX icon, user may click left button of mouse to specify a suitable position as the rotate center, and move the cursor up and down to rotate the model.

11.  VIRTUAL Y ROTATION

The displayed model will dynamically rotate about the global Y-axis when the cursor is moved up or down. Default rotate center is the model center. If Define Rotate Center is open, user may define rotate center. After clicking the VY icon, user may click left button of mouse to specify a suitable position as the rotate center, and move the cursor up and down to rotate the model.

12.  VIRTUAL Z ROTATION

The displayed model will dynamically rotate about the global Z-axis when the cursor is moved up or down. Default rotate center is the model center. If Define Rotate Center is open, user may define rotate center. After clicking the VZ icon, user may click left button of mouse to specify a suitable position as the rotate center, and move the cursor up and down to rotate the model.

13.  SCREEN X ROTATION

The displayed model will dynamically rotate about the screen X-axis when the cursor is moved up or down. Default rotate center is the model center. If Define Rotate Center is open, user may define rotate center. After clicking the SX icon, user may click left button of mouse to specify a suitable position as the rotate center, and move the cursor up and down to rotate the model.

14.  SCREEN Y ROTATION

The displayed model will dynamically rotate about the screen Y-axis when the cursor is moved up or down. Default rotate center is the model center. If Define Rotate Center is open, user may define rotate center. After clicking the SY icon, user may click left button of mouse to specify a suitable position as the rotate center, and move the cursor up and down to rotate the model.

15.  SCREEN Z ROTATION

The displayed model will dynamically rotate about the screen Z-axis when the cursor is moved up or down. Default rotate center is the model center. If Define Rotate Center is open, user may define rotate center. After clicking the SZ icon, user may click left button of mouse to specify a suitable position as the rotate center, and move the cursor up and down to rotate the model.

16.  FREE ROTATION

This function is a combined rotation of Screen X Rotation and Screen Y Rotation. Moving the mouse up/down manipulates Screen X rotation. Moving the mouse left/right manipulates Screen Y rotation. Moving the mouse diagonally combines the rotations of both directions. Click the left

mouse button to stop the rotation. The user may activate this function by pressing Control and left mouse button while moving the mouse. Release the mouse button to stop the rotation.

Default rotation center is the model center. If Define Rotate Center is open, user may define rotate center. After clicking the icon, user may click left button of mouse to specify a suitable position as the rotate center, and move the cursor up and down to rotate the model.

17.  PAN

This command enables the user to translate the model on the screen by following the movement of the cursor. If the cursor is moved off the graphics display window, the cursor reappears at the opposite edge of the window to continue the operation. Click the left mouse button to stop the pan operation. The user may activate this function by pressing Control and Middle mouse button while moving the mouse. Release the mouse button to exit the function.

18.  CURSOR ZOOM

The user picks a point about which to zoom. The model is centered about this point and the user may move the cursor up to zoom in or down to zoom out. The user may activate this function by pressing Control and right mouse button while moving the mouse. Release the mouse button to exit the function.

Note: *If the cursor is moved off the graphics display window in functions ROTATE, PAN or CURSOR ROOM, the cursor re-appears at the opposite of the window automatically to continue the operation.*

19.  WINDOW ZOOM

The user defines the corners of the zoom window by positioning the cursor on the display screen. The user presses and holds the left mouse button and drags the cursor diagonally until the desired window size is reached. Releases the left button, the area included in the window will be displayed in full screen.

20.  FREE HAND ZOOM

The user defines a free region by pressing the left mouse button and dragging the cursor on the display screen to define the region. Releases the left button, the area included the region will be displayed in full screen.

21.  FILL

Rescale the model to include all entities that are currently displayed. FILL automatically zooms in or out until the model fits the viewing area of the screen.

22.  TOP VIEW

Automatically displays the model from the TOP or in the XY-plane.

23.  Y-Z VIEW

Automatically displays the model from the RIGHT or in the YZ-plane.

24.  X-Z VIEW

Automatically displays the model from the LEFT or in the XZ-plane.

25.  ISOMETRIC VIEW

Automatically displays the model from the isometric plane (60-degree isometric).

26.  CLEAR

Remove the highlighted entities from the screen.

27.  IDENTIFY NODE

This function enables the user to identify any node by cursor selection (default) or key in node number. The program labels the node number of the selected node is highlighted on the screen and the outputs the coordinates in the message window. Figure 1.3 shows the CONTROL OPTION window when the function starts.

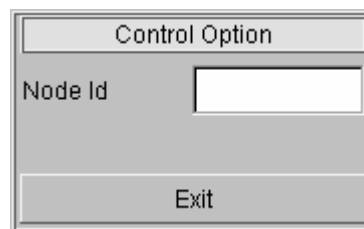

Figure 1.3 Identify Node Control Option window

- Node ID

Select by cursor is the Default fashion. The program highlights the node that is nearest the cursor. Click the left mouse button when the desired node is traced. The selected node will be

labeled with the node number. User also can key node ID in the input box. This option allows user to identify the node by entering a node number.

28.  IDENTIFY ELEMENT

This function enables the user to identify any element, its part and its nodes by cursor selection (default) or key in element ID number. The program will highlight the selected element with the element number on the screen and also display the element connectivity in the message window. The operation of this function is same as the IDENTIFY NODE function.

29.  DISTANCE BETWEEN TWO NODES/POINTS

This function calculates the distance between two nodes/points selected by cursor pick or key in node number/point number. The program displays a CONTROL OPTION window as shown as Figure 1.4.

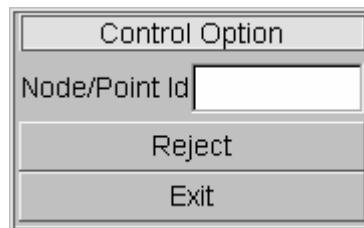

Figure 1.4 Measure distance Control Option window

Operation of SEELECT BY CURSOR and KEY IN ID are the same with IDENTIFY NODE function. REJECT LAST allows user to reject the last selected node. Once two nodes are selected, the program labels the distance and X, Y, Z components between the selected nodes on the screen and also outputs the information in the message window.

30.  ANGLE BETWEEN THREE NODES

This function measures the angle between two vectors formed by three nodes. The first selected node defines the vertex of the angle. The program displays a CONTROL OPTION window that is common with the one in DISTANCE BETWEEN TWO NODES function. Once three nodes are selected, the program labels the angle at the vertex node and outputs the information in the message window.

31.  ANGLE BETWEEN TWO LINES

This function is used to measure the angle between two lines that are composed by selected four nodes. Default setting is to select by mouse click or inputting node numbers. After selecting four nodes, program displays the angle at the two lines by selected four nodes and at the same time

output information in the information window.

32.  RADIUS BETWEEN THREE NODES

This function enables the user to measure the radius of an arc that is passing through three selected nodes by cursor selection (default) or key in node number. After selecting three nodes the program will display the radius on screen and output the coordinates of the center of the arc in message window.

33. POSTPROCESS ICON

The functions in the POSTPROCESS icon bar allow the user to access the functions to process the result files. There are two kinds of icon on the eta/Post, one is global icons, which control part on/off, views, and dynamic rotation. The second group of icons controls the type of post processing to be performed; deformed shape, stress, vector plots, and graphing. There are icons specializing for eta/DYNAFORM result, located in the control window. As shown in Figure 1.5 and Figure 1.6, each of these icons is described in Chapter 7.



Figure 1.5 Post process functional icons in icon bar



Figure 1.6 Special icons for eta/DYNAFORM result

1.4. DISPLAY OPTIONS

The DISPLAY OPTIONS window displays the current part and contains the following commonly used functions.

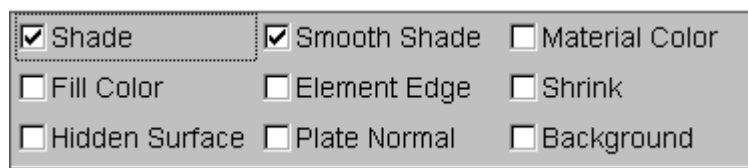

1. SHADE (toggle)

This command displays the elements as if they were illuminated by a light source. Elements that are not directly exposed to the light source are appropriately “shaded” to simulate the actual shading effect.

Eta/Post uses two methods for object shading: flat and smooth. Flat shading shades each polygon upon the intensity of the light over a series of polygons making the elements appear flat and angled.

2. SMOOTH SHADE (toggle)

This function uses the Gourand shading method to make the model appears more smoothly. It interpolates shade across edges, reduces effect of intensity change. The feature angles between adjacent elements are smoothed by this shading method.

Note: *The SMOOTH SHADE option is only available when the SHADE option is on.*

3. MATERIAL COLOR (toggle)

This function can only be used in SHADE mode. If the function is toggled on, the model will be plotted in gray color during deformed plot or animation deformation and the parts without stress/strain during contour plot or animation. If the parts are defined with material color in Part Attribute function, they will be shaded in the material color.

Note: *The GRAY COLOR option is only available when the SHADE option is on.*

4. FILL COLOR (toggle)

This function toggles on/off the model in FILL COLOR mode. FILL COLOR fills the displayed elements with their designated part color.

5. ELEMENT EDGE (toggle)

This function can only be used in FILL COLOR mode. The outline of the elements is plotted in white when the option is toggled on. The model can be displayed without the outline by toggling off the option.

Note: *The ELEMENT EDGE is only available when the FILL COLOR or SHADE option is on.*

6. SHRINK (toggle)

SHRINK creates a plot with elements reduced in size by 20 percent. This option allows the user to toggle the function on/off.

7. HIDDEN SURFACE

This function toggles on/off the model in HIDDEN SURFACE mode. HIDDEN SURFACE hides the elements behind the elements viewed from the user's point of view.

8. PLATE NORMAL (toggle)

This function toggles plate normal on and off. The plate normal is shown with a vector drawn at the center of element and along the element's normal direction.

9. BACKGROOUND (toggle)

If this function is toggled on, the background color is set to white. Otherwise, default background color is black. User may open EDIT menu in Background color menu adjust background color.

1.5. PRIORITY OF FUNCTIONS

The functions in eta/Post are prioritized. Functions in Display Options can be accessed to at any time. The functions in Edit and Tool menu have the highest priority. If any of these functions is started, all other functions in eta/POST are disabled.

Control Window has the lowest priority. The user is enabled to access other functions when Control window is opened. Only functions in Edit menu, Tool menu and Display Option are allowed to be used during animation.

1.6. CONTROL WINDOW AND CONTROL OPTION

eta/Post incorporates two types of window, FUNCTION DIALOG WINDOW and CONTROL WINDOW. At the bottom of the FUNCTION DIALOG WINDOW there are buttons to execute, reject, reset the data or close the window. The functions of these buttons are listed below.

APPLY	Executes the current function
CANCEL	Rejects the current operation
EXIT	Exits the current window
OK	Accepts the data in the dialog box and forwards the user to the next step.
UNDO	Rejects the last step of the operation.
REDO	Allows user to restore to the operation before UNDO
RESET	Restores the original set
REJECT	Rejects the previous selection

1.7. FILE FORMAT

The protocol for naming files during an eta/Post session includes attaching suffixes to the file names that specify the file types. The appropriate file names are listed in the option area of the display screen.

DYNA result file (d3plot, d3drif, dynain)

DYNA model file (*.dyn)

DYNA result file of eigenvalue analysis (d3eigv)

NASTRAN results file (*.pch, *.op2)

NASTRAN model file (*.nas, *.dat)

DYNAFORM/VPG/FEMB LINE DATA file (*.lin)

eta3DPlayer 3D display file format (*.e3d)

eta/Post can open DYNA result file to process the results directly. After the NASTRAN result file is loaded, the program will require loading the corresponding NASTRAN model file. The user may import LINE DATA, DYNA or NASTRAN model file.

1.8. CONFIGURATION FILE

The etapost.config file or initialization file controls the default setting of eta/Post. This file is located in the installation directory and can be edited via the text editor. The normal content of the etapost.config file is:

```
#ETA/Post User Configure File
[GRAPHIC ENGINE]
Renderer Volume Factor = 2
Z Buffer Bit = 16
Color Buffer Bit = 16
Edge Color = 255 255 255
Background Color = 0 0 0
Faded Background Type = 1
Xor Plotter Styler = GDI
Light Source Type = LOCAL
Second Render = OFF
Mouse Trace = OFF
Debug = OFF
Define Rotate Center = ON
Polygon Offset = ENABLE
Frame Rate = 10
Default
Material(ALUMINIUM,COPPER,SILVER,STEEL) = STEEL

[WINDOW PARAMETER]
Layout Type = RIGHT

[PRODUCT PARAMETER]
Product Name = DYNAFORM

Extended GUI = ON
Language Type = ENGLISH

[COLORMAP SETTING]
Color Id 1 = 0 0 0
Color Id 2 = 255 0 0
Color Id 3 = 255 100 50
Color Id 4 = 255 255 0
Color Id 5 = 146 138 50
Color Id 6 = 160 255 27
Color Id 7 = 50 250 0
Color Id 8 = 0 140 0
Color Id 9 = 100 243 243
Color Id 10 = 77 174 255
Color Id 11 = 0 0 200
Color Id 12 = 150 50 255
Color Id 13 = 255 90 148
Color Id 14 = 220 0 210
Color Id 15 = 150 147 143
Color Id 16 = 255 255 255

[DRAW SETTING]
Line Element Width = 3
```

[STONING SETTING]

Defect A = 0.01

Defect B = 0.1

Defect C = 0.2

Defect D = 0.5

Stone Length = 10

Unit Type(MM,INCH) = MM

<Wrinkle tendency > = 0 200 255

<Wrinkle > = 255 181 255

<Serere wrinkle > = 220 0 210

<Inadquate stretch > = 200 200 200

[PRINTER SETTING]

File Type = JPEG

[CONTOUR SETTING]

Lower Limit Color = 14 122 14

Upper Limit Color = 9 37 122

[LICENSE SETTING]

Check Type (CHECK_ALL,

LSTC_ONLY,ETA_ONLY)=CHECK_ALL

[FLD DEFAULT SETTING]

Curve Type (ENGINEERING

OR TRUE) = TRUE

<Crack > = 255 0 0

<Crack risk tendency> = 255 255 0

<Severe thinning > = 255 165 79

<Safe > = 100 255 0

[FILE MANAGER]

File Type = 0

Macro Index = ON

[DIRECTORY]

Home = D:\Software_test\op10

2

GETTING STARTED

The user begins a session by entering the program name "eta-POST" at the Linux/UNIX prompt, or double clicking the eta/Post icon at the Windows. Once the program is activated, it displays the program window and is ready for operation. Figure 2.1 shows the main GUI.

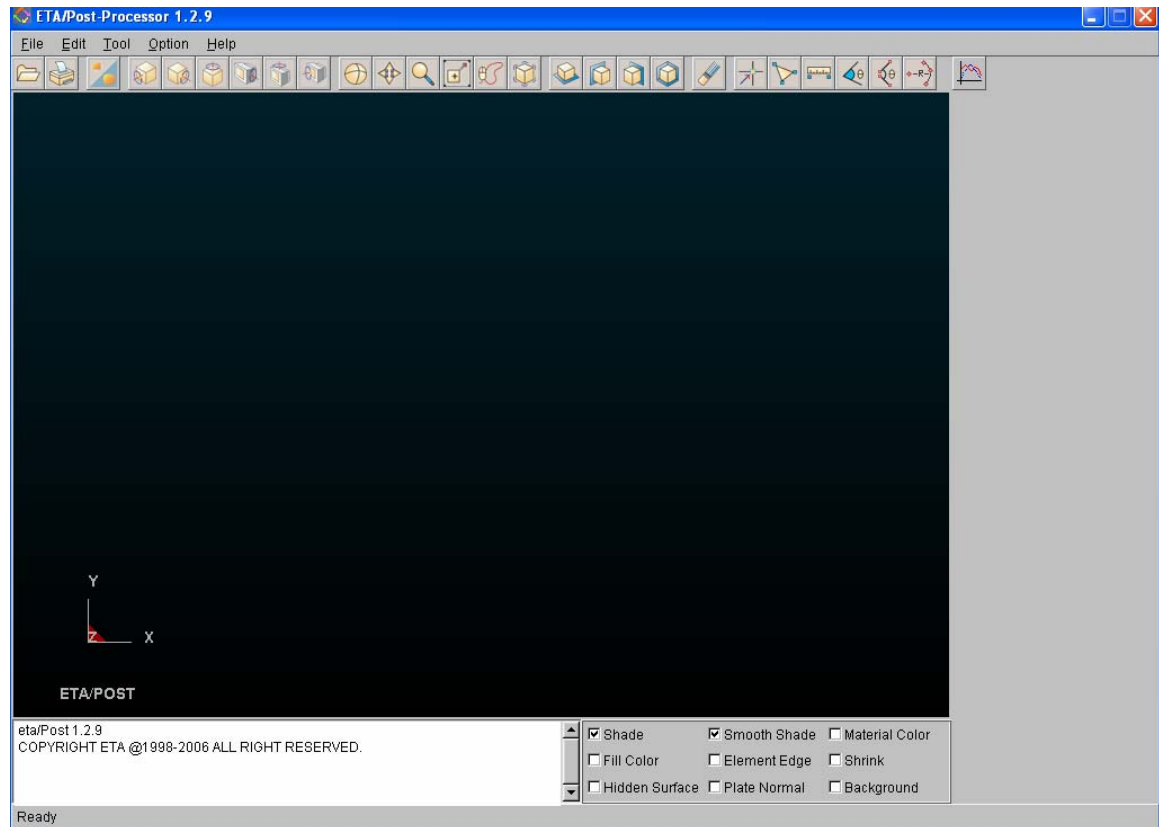

Figure 2.1 eta/Post GUI

2.1. GETTING STARTED WITH D3PLOT FILE

Start eta/Post and open the desired file via the OPEN command in the FILE MENU. This function displays the Open File dialog and allows the user to read result file or model file into eta/Post. Figure 2.2 shows the SELECT FILE window.

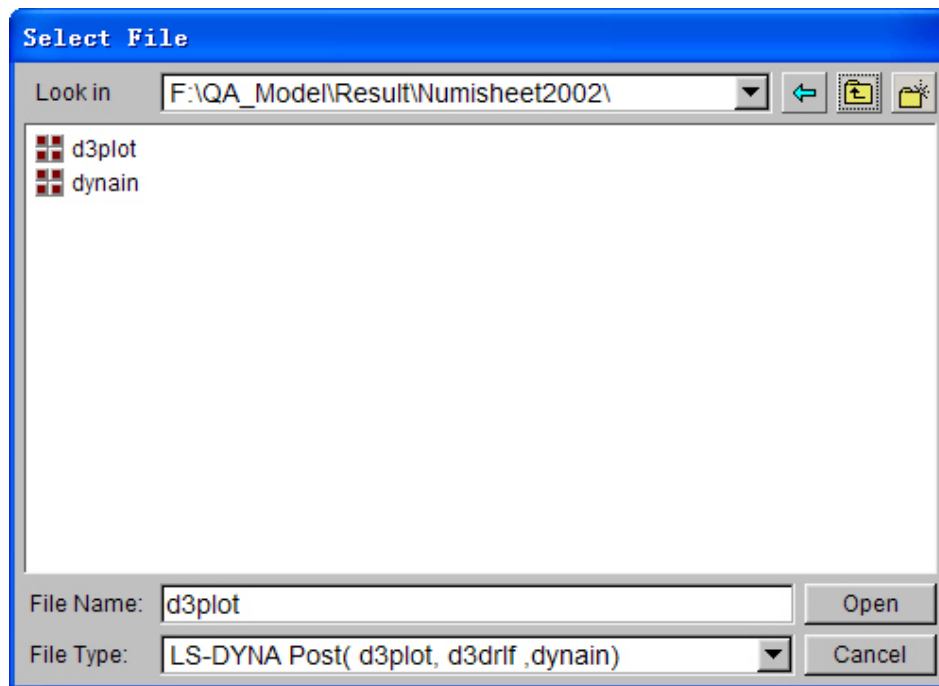

Figure 2.2 Select File window

1. LOOK IN

Allow the user to navigate directories when opening/saving files.

2. FILE NAME

Allow the user to specify the name of the file to open/save.

3. FILES OF TYPE

Allow the user to specify the type of file to open/save. The available file types are displayed in the drop down list. The SELECT FILE window only displays the files that match the current FILES OF TYPE extension.

2.2. INDEX File

Index file (.idx) is written by pre-processor together with dyn, mod file under the same directory. It is mainly used to transfer process parameter to post processor. If there are more than one idx file under the same directory, when post processor opens another result, it prompts user to select a matching idx file with the result. Figure 2.3 shows the dialog to select idx file. Detailed information of index file refers to reference APPENDIX A.

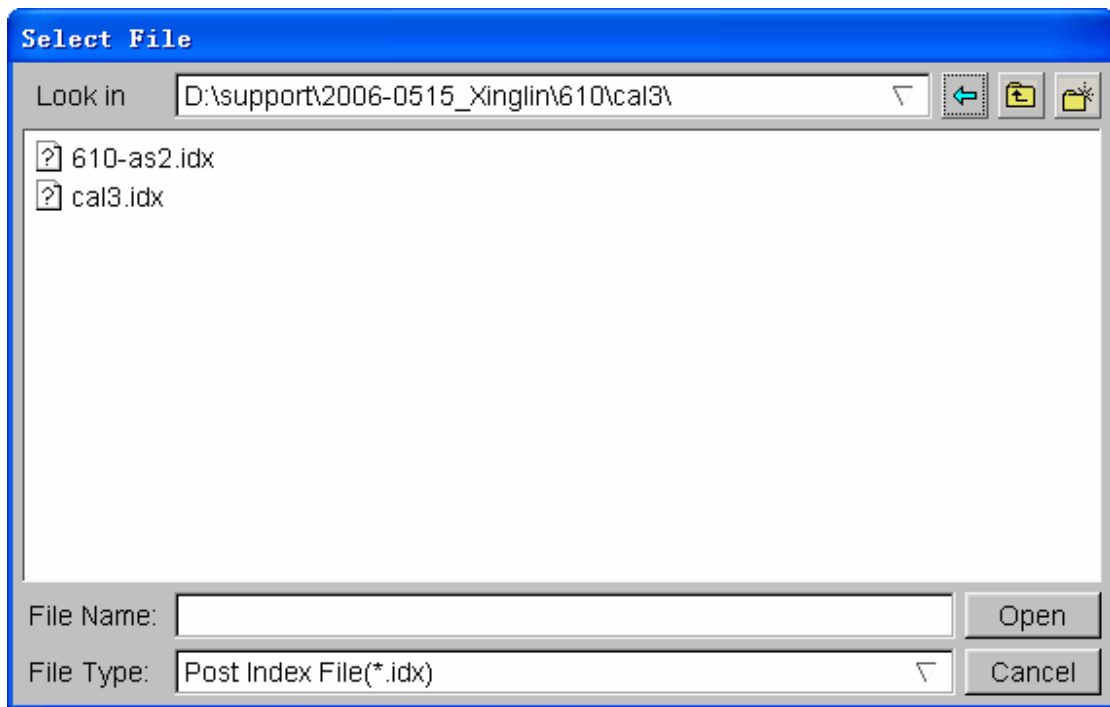

Figure 2.3 Select idx File Window

2.3. REQUIREMENTS

eta/Post is compatible with LS-DYNA/PC 940, 950,960 and 970 It will run in a Windows 98 or NT 4.X(or later) or LINUX?UNIX operating system. It is not recommended for use with earlier versions of Windows. The following are minimum requirements for proper operation of eta/Post in a Windows environment:

1. Minimum Graphics Requirement:

800 x 600 (requires small fonts)

NOTE: *The monitor resolution is determined by the Windows display settings. The settings can be accessed by clicking the right mouse button on the Windows desktop and selecting **PROPERTIES** from the pull down menu and **SETTINGS** from the displayed pop-up window. These settings can also be accessed through the **WINDOWS START MENU/SETTINGS/CONTROL PANEL/ DISPLAY**.*

2. Minimum Memory Requirement:

Small model (10,000-20,000 elements)	256 megabytes RAM
Medium model (20,000-100,000 elements)	512 megabytes RAM
Large model (100,000-300,000 elements)	768 megabytes RAM
Huge model (300,000-1,000,000 elements)	1GB+RAM

3. Graphics Card:

OpenGL (recommended) or DIRECT 3D (sufficient) with 8 megabytes video RAM

3

FILE MENU

The options in this pull-down menu are used to open, save, import, export, and print related files,. It copies model in graphic area to clipboard and printing related files. See Figure 3.1.



Figure 3.1 The file menu

A detailed description of each function is given in the following sections.

3.1. OPEN

This function displays the Open File dialog and allows the user to read result file or model file into eta/Post. The open file dialog is shown in Figure 3.2.

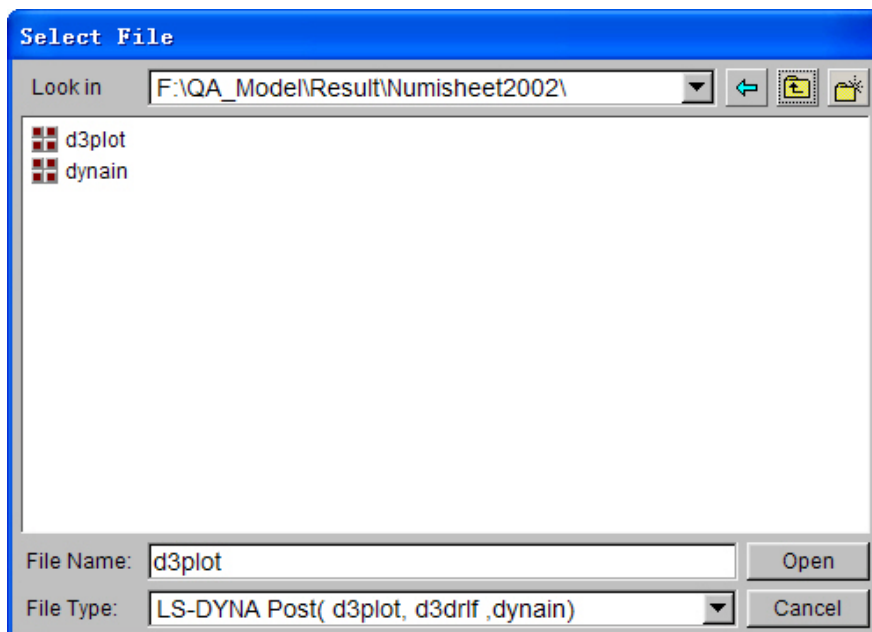

Figure 3.2 Select File window

To open result file or model data, select File Type that will be read in. Locate the desired file using the browser and click OPEN. The model will be displayed in the Graphic Display Window and will be ready for post processing.

Eta/Post 1.0 supports LS-DYNA d3plot, d3eigv and d3drif, NASTRAN punch and output2 result files for post processing. The program will display the Select File window again for the user to select a Nastran model file after the Nastran result file is loaded. It is necessary to select a matching Nastran model in order to post-processing the result correctly.

3.2. IMPORT

This function allows the user to import DYNAFORM/VPG/FEMB Line Data file for SKID MARK and BLANK OUTLINE functions. The Import File dialog is shown in Figure 3.3.

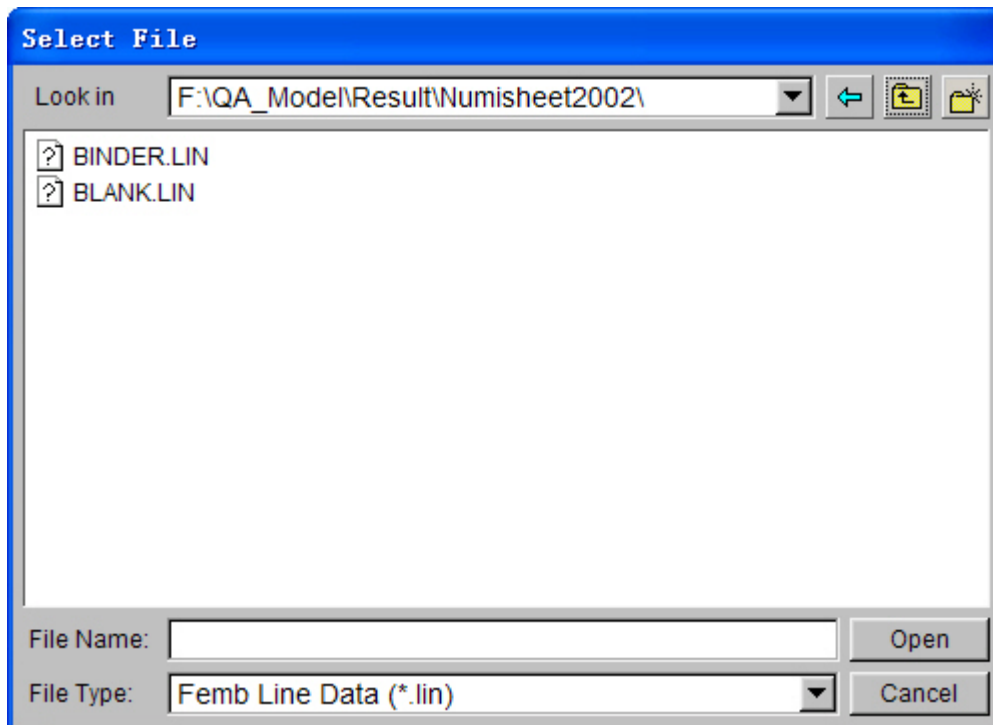

Figure 3.3 Import File window

User can select a DYNAFORM/VPG/FEMB Line Data file, then click OPEN button, or double click the desired file icon from the file name list to import it.

Note: *IMPORT function is disabled until a d3plot file or NASTRAN punch/output2 file is read in.*

3.3. EXPORT

This function allows user to export the current model as NASTRAN file or DYNAFORM/VPG/FEMB line data file. The Export File dialog is shown in Figure 3.4.

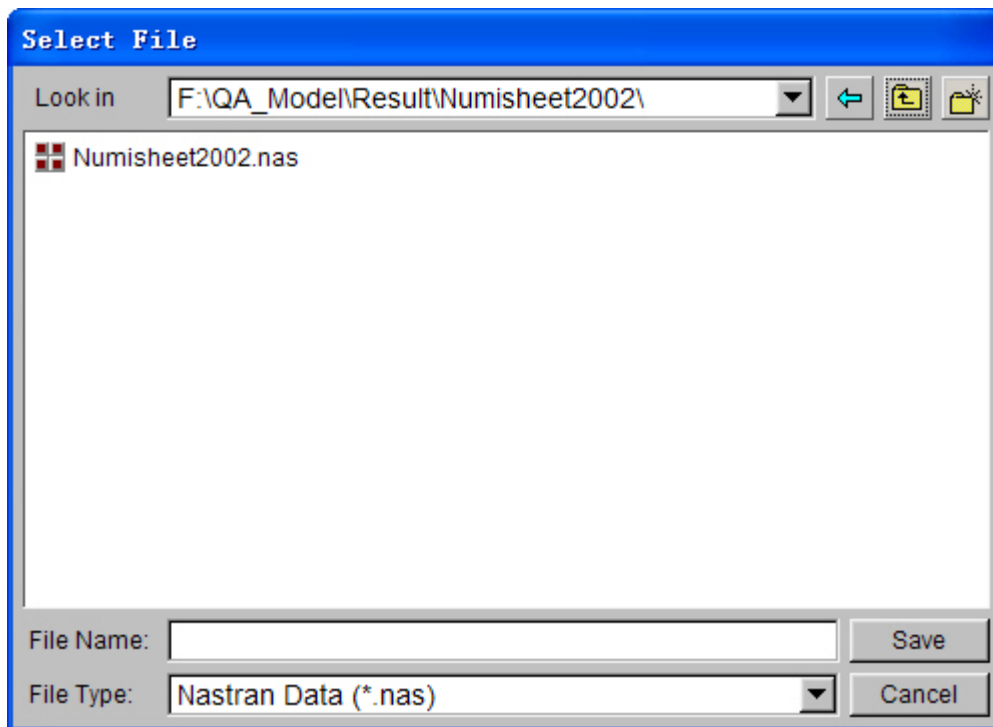

Figure 3.4 Export file dialog box

User can export the model turned on in the current database as the NASTRAN FILE. Give a file name, then click SAVE button to export the model in the selected file format.

Note: EXPORT function is disabled until a d3plot file or NASTRAN punch/output2 file is read in.

3.4. COPY TO CLIPBOARD

This function allows the user to save the model displayed in the GRAPHICS DISPLAY window to the clipboard in the Windows environment. The image in the clipboard can be pasted to the document files.

3.5. PRINT

The PRINT function prints the contents of the graphics display window to a printer or saves it to a image file.

This function allows the user to define the default settings for printing or saving image files. The options are shown in Figure 3.5.

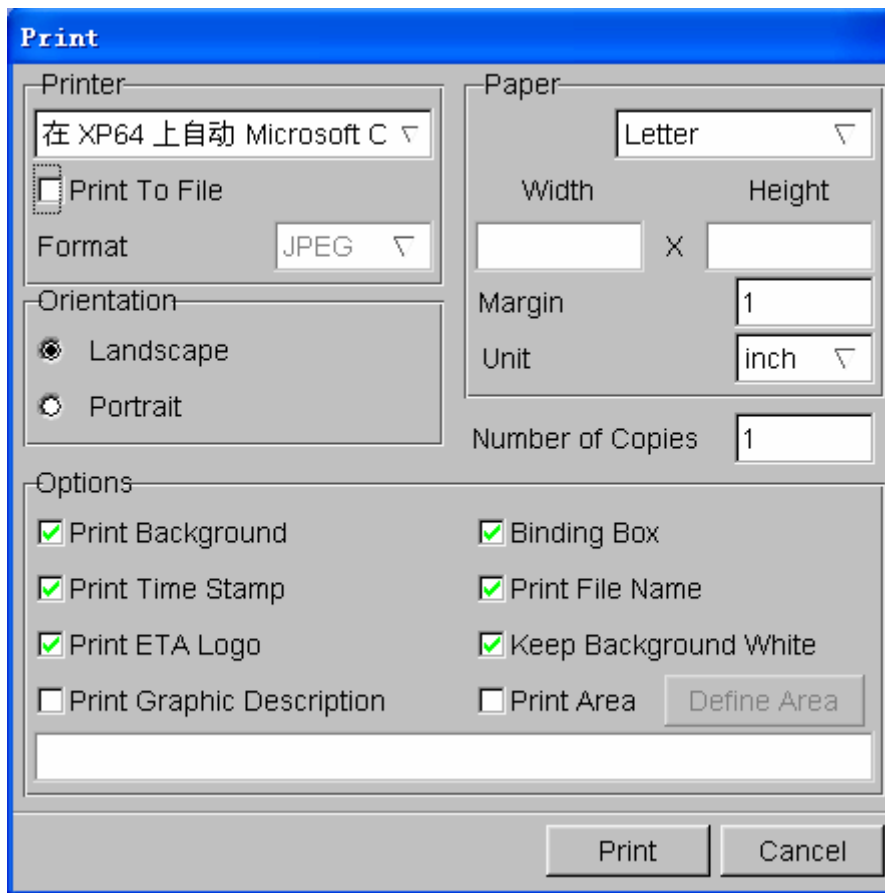

Figure 3.5 Print window

1. PRINTER

The user can select a printer or select a format to print to a file.

Enter the printer name in the field or select from the drop down list and click PRINT to print the image.

If PRINT TO FILE option is selected, the user can choose a format by selecting the options in the drop down list in FORMAT window. DYNAFORM supports Postscript (PS), Encapsulated Postscript (EPS), GIF and JPEG file formats.

Note: *When PRINT TO FILE is selected, the program will prompt the user to enter a filename to save the current display to a file of the specified format.*

2. PAPER

The user can specify the paper size and/or margin for the image print out.

Select the button at the top left to choose a paper size.

Note: *The supported sizes are: LETTER - 8.5x11 inches; A4 - 8.26x11.69; and B5 - 7.17x10.13.*

Users can also specify a paper size for a specific paper by entering size in the width and height field.

Enter a number in the field next to MARGIN to define the margin of the shorter edge of the paper. The program automatically determines the margin of the other edge in order to maintain the original aspect ratio of the picture. This feature can also be used to scale the picture.

Select the drop down option next to UNIT to choose the unit (inch or mm) used for paper size and margin.

3. ORIENTATION

This function defines the image orientation as landscape or portrait on the printed copy.

4. OPTION

These options are for defining printer output and layout on the paper.

- PRINT BACKGROUND

If this function is toggled on, the background color of the screen will be included in the print out. If this function is toggled off, there will be no background color on the print out.

- BOUNDING BOX

This function draws a line frame around the picture's border.

- PRINT STAMP TIME

This function prints the current time at the lower right corner of the picture.

- PRINT FILE NAME

This function prints the file name at the lower left corner of the picture.

- PRINT ETA LOGO

This function prints eta/DYNAFORM at the lower right corner of the picture.

- PRINT GRAPHIC DESCRIPTION

If the function is toggled on, the field below the switch is enabled to use. User can enter a string of characters to describe the current image to be printed on the print out.

- KEEP BACKGROUND WHITE

When this option is toggled on, set the graphic background with white color before print to file or print to printer.

- PRINT AREA

When opening this option, the Define Area button beside is activated. Click Define Area button to open following dialogue box, and left click in graphic area and drag out an area as defined graphic output area.

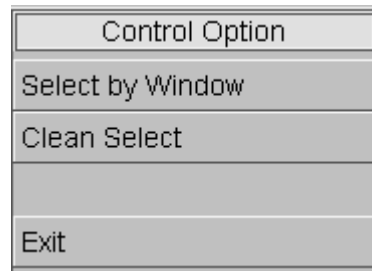

Figure 3.6 Select Print Area Dialogue Box

- NUMBER OF COPIES

This function allows the user to print multiple copies to the printer. It has no effect on the PRINT TO FILE option.

5. PRINT

This function will send the model to a selected printer or prompt the user to enter a file name to save the file.

6. CANCEL

This function allows user to exit the function, and reject any selections made.

3.6. PRINT TO FILE

This function is used to save the content in display area as graphic file. Its interface is asFigure 3.7:



Figure 3.7 Print to File Window

3.7. QUIT (ALT+Q)

Selection of this option ends the current eta/Post session and returns back to eta/DYNAFORM pre processing environment. If the user is executing eta/Post from a stand-alone mode, this option terminates the eta/Post software.

4

EDIT MENU

The functions in the Edit menu allow the user to modify the setting of the model display. Figure 4.1 shows the drop down list of the Edit functions.



Figure 4.1 Edit menu

A detailed description of each function is given in the following sections.

4.1. CREATE LINE

This function enables the user to create a line by selecting a set of nodes. In eta/Post a line is formed by a sequence of points. The program displays the line by a set of straight-line segments between adjacent points in sequence. The generated lines are included in a new part. The program displays a CONTROL OPTION window as shown as Figure 4.2.

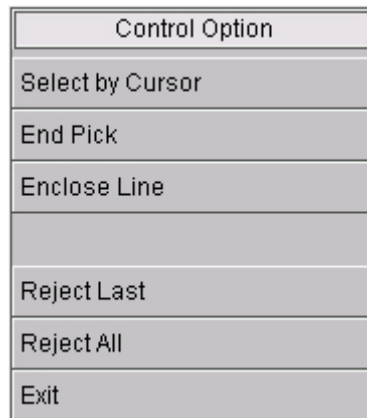

Figure 4.2 Create Line Control Option window

1. SELECT BY CURSOR

Select the location of the node, a point will be created.

2. END PICK

Click this button to create a line by a set of straight-line segments between adjacent points in sequence.

3. ENCLOSE LINE

The created line is closed by a straight-line segment between the first selected and the last selected point.

4. REJECT LAST

The last selected node is rejected.

5. REJECT ALL

All selected nodes are rejected.

6. EXIT

Exit the function.

4.2. DELETE LINE

This function enables the user to delete the selected line(s).

4.3. LABEL/ARROW

LABEL allows the user to enter a title or text label at any location in the graphic display window. ARROW allows the user to draw arrows at any location in the display window. The program displays a control window as shown in Figure 4.3



Figure 4.3 Label and Arrow Control Option Window

1. DISPLAY LABEL/ARROW

Controls the Label/Arrow display in the graphic display window. Default is toggled on.

2. FONT SIZE

This function is used to control font size of the text. Mouse click the pulling-down menu beside to select font size. Default value is Pt12.

3. ARROW

This function enables the user to select two points by cursor to draw an arrow in the graphic display window. The name of the arrow will be listed in the Label/Arrow control window. The first location is the tail of the arrow and the second location is the arrow head.

4. TEXT

This function allows the user to add a text label in the graphic display area. Enter a string of characters in the field above the TEXT button. Press the TEXT button then click a location on the screen. The program will add the text label at the clicked location.

5. DELETE

Delete an arrow or a text label. The program will highlight the arrow or text label on the screen as the user selects an arrow or text label in the list. Click DELETE button to delete the highlighted arrow or text label. The user may combine the Shift or Cntrl key and mouse click for multiple selections.

6. EXIT

Exit the function.

4.4. ROTATE LIGHT

eta/Post uses two light sources directed from the specific locations from the model. This function allows the user to rotate the light sources along the screen X Y axes. The function only works when the SHADE option is turned on. The program displays the light source 1 and 2 and their lighting directions when the function starts. The user uses the mouse to move the light sources on the screen. The lighting effect is updated as the user moves the mouse. Press the left mouse button to exit the function. The user may activate this function by pressing the SHIFT and LEFT mouse button simultaneously. Release the mouse button to exit the function.

4.5. LIGHT PROPERTY

This function allows the user to change the light property and the material property for gray shading. This function only works when the SHADE option is turned on. The program displays the LIGHT PROPERTY control window as shown in Figure 4.4

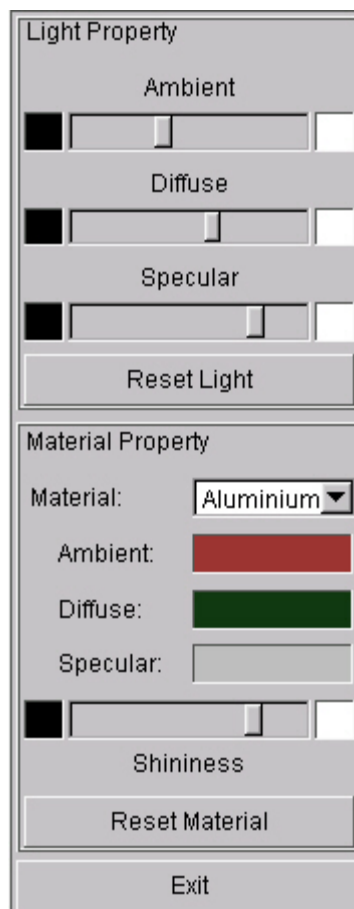

Figure 4.4 Light Property Control Option Window

1. LIGHT PROPERTY

The light property allows the user to adjust the brightness and shininess of the part by adjusting the setting of Ambient, Diffuse and Specular light. The LIGHT PROPERTY only works when the SHADE option is turned on. The user may click and drag the slider in each light property to adjust the light property. Slide to the right results in more brightness or reflection of the display.

- AMBIENT

Ambient light is a uniform light source coming from all directions to the part.

- DIFFUSE

Diffuse light is a parallel light source coming from the light source direction. This light is reflected evenly from the part surface.

- SPECULAR

Specular light is similar to the diffuse light except the light is reflected sharply in a particular direction.

- RESET LIGHT

Reset the light property to the default setting.

2. MATERIAL PROPERTY

eta/Post allows the user to modify different material properties for rendering the part. The material property only takes effect in the SHADE mode with GRAY COLOR option.

- MATERIAL

User may select the material from the Material drop down list. The available materials are: aluminum, steel, copper, gold, iron, silver, bronze and rubber. User may assign a material to selected parts by using the PART ATTRIBUTE function.

- MATERIAL COLOR

The program provides adjustment for AMBIENT, DIFFUSE and SPECULAR color by clicking the color box next to the property type. The program displays a control window as shown in Figure 4.5

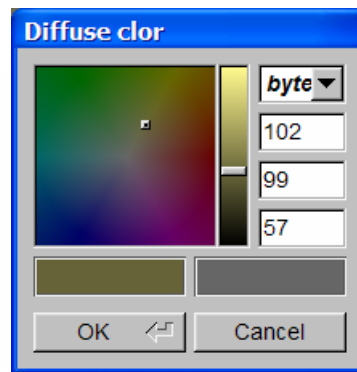

Figure 4.5 Light Adjustment Control Window

The user may click and drag the marker in the color map window to change the color of the selected material. The program updates the model display with the new material color in the graphic display window. It also shows the new material color in the color box on the low left side of the control window. The user can compare the new material color with the original color on the right. The user may also click and drag the slider in the vertical bar to adjust the brightness of the selected material. The RGB values of the material color are shown in the column on the right side of the control window. The user may change these values to change the material color. The user may choose any of the four scales to show the RGB values: Byte, RGB, Hex or HSV. When the desirable color is obtained, click OK to accept the color and exit the control window. Otherwise, click CANCEL to reject the color and exit the control window.

- SHININESS

The user may click and drag the slider to adjust the shininess of the selected material.

- RESET MATERIAL

Resets the material color to the default setting.

3. EXIT

Close the light property control window and exit the function.

4.6. COLOR MAP

Eta-Post uses 14 different colors to distinguish parts in the model. This function enables the user to modify any part color from default setting. The program displays the COLOR MAP control window as shown in Figure 4.6

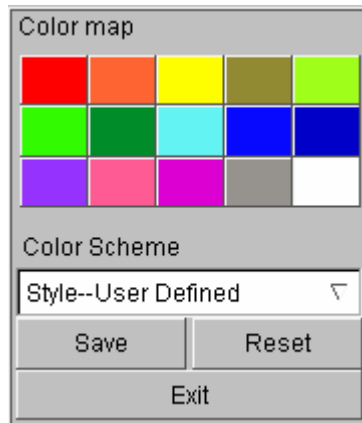

Figure 4.6 Color Map Control window

The user may select any color to modify by clicking on a color block in the color palette. The program will display a change part color control window as shown in Figure 4.7

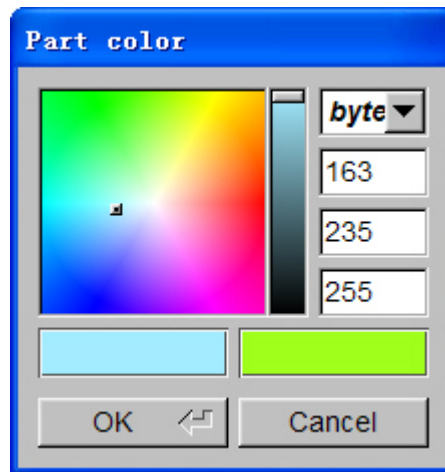

Figure 4.7 Part Color Control window

The procedure of changing Part Color is same as in Change Material Color that has been described in section 4.6.

1. COLOR SCHEME

This function is used to switch color scheme. User may select color scheme by clicking the pulling-down menu below. There are three types of color scheme: Style-User Defined, Style-ETA, Style-LSTC. Default style is Style- User Defined.

2. SAVE

This function is used to save the COLOR SCHEME.

4.7. PART ATTRIBUTES

The functions in PART ATTRIBUTES control window allow the user to customize the display

characteristics for selected parts in the model. There are five options. The default PART ATTRIBUTES control window is shown in Figure 4.8

1. COLOR

The user may change part color from the color list. Click on the PART COLOR option and select the parts from the part list window or click the part from the screen. The program will mark the part name with an asterisk (*) and highlight the parts on the screen. Select a color from the color table to change the part color. Then click APPLY below the control window. The program will change the color of the selected part on the screen and the part name in the window. Please see the Figure 4.8.



Figure 4.8 Part Attributes control window (Part Colour)

2. MATERIAL

This option allows the user to assign material property to the selected parts when the GRAY SHADE (Material Color, SHADE) option is turned on. The available materials are: aluminum, steel, copper, iron, Gold, silver, bronze and rubber. Click on the MATERIAL button and select a material type from the draw down list. Then the user can select the parts from the part list window or click the parts from the screen. The program will mark the part name with an asterisk (*) and highlight the part on the screen. Clicks APPLY and the selected parts will be endowed with the specified material. The changes of part's material can be show only when the SHADE and GRAY option are turned on. Please see the Figure 4.9.

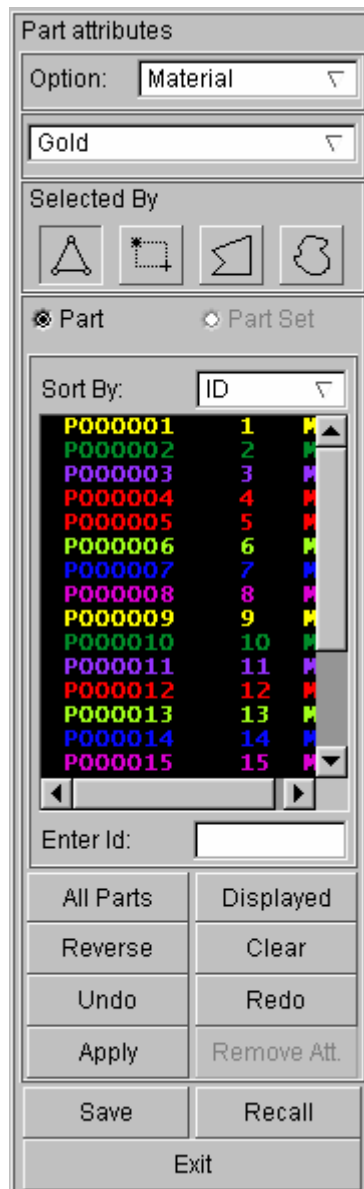

Figure 4.9 Part Attributes control window (Part Material)

3. TRANSPARENCY

This option allows the user to make the selected parts transparent when the SHADE option is turned on. Click on the TRANSPARENCY button and select the parts from the part list window or click the parts from the screen. The program will mark the part name with an asterisk (*) and highlight the part on the screen. Clicks APPLY and the transparency slider will be active. The user may use the transparency slider to adjust the degree of transparency. Slide to the left will make the selected parts more transparent. The program will show the selected parts transparent when the SHADE option is turned on. Please see Figure 4.10.

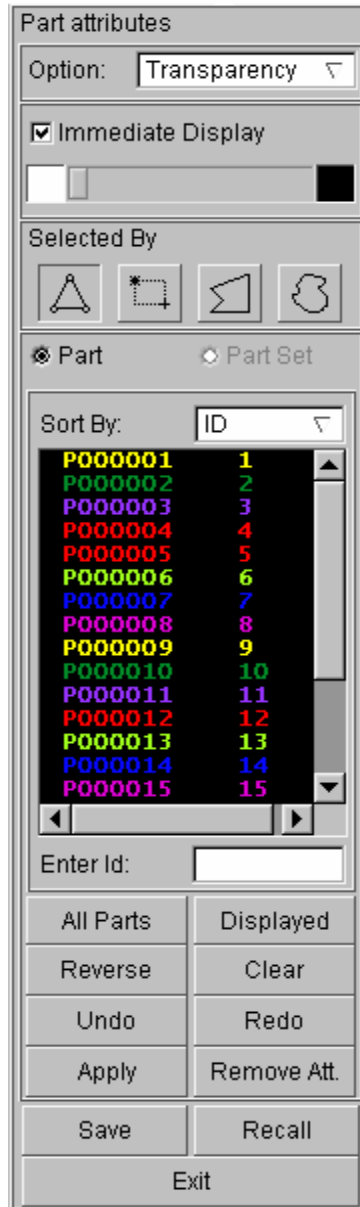

Figure 4.10 Part Attributes control window (Transparency)

4. WIREFRAME

This option allows the user to display the selected parts in wire frame when the SHADE option is turned on. Click on the WIREFRAME button and select the parts from the part list window or

click the parts from the screen. The program will mark the part name with an asterisk (*) and highlight the part on the screen. The program will not shade the selected parts when the SHADE option is turned on. Please see Figure 4.11.

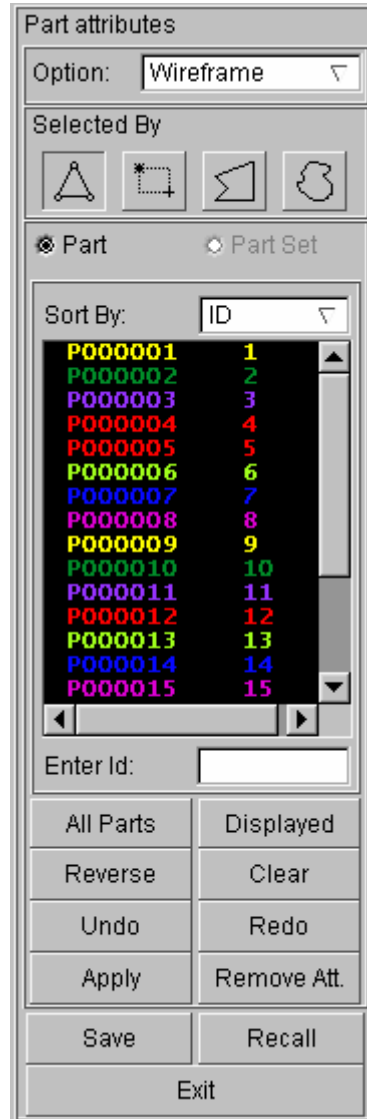

Figure 4.11 Part Attributes control window (Wire Frame)

5. NO CONTOUR

The user may choose not to show contour result in select parts. Click on the NO CONTOUR option and select the parts from the part list window or click the part from the screen. The program will mark the part name with an asterisk (*) and highlight the parts on the screen. Clicks APPLY and the program will not display contour of the selected part during CONTOUR ANIMATION. Instead, the selects parts will be plotted in gray color. Please see Figure 4.12.

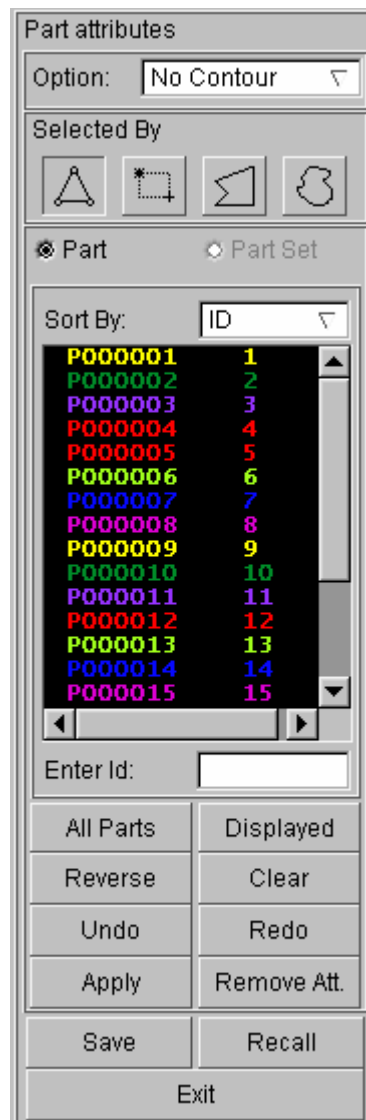

Figure 4.12 Part Attributes control window (No Contour)

There are some functional buttons on the Part Attributes window for user to easy operate the parts.

6. ALL PARTS

Enable the user to select all the parts on the current database.

7. DISPLAYED

Enable the user to select all the parts that are displayed in the current window.

8. REVERSE

Enable the user to reverse the selected parts. All the selected parts will be unselected and all the unselected parts will be selected.

9. CLEAR SELECTION

Turn all the selected parts to unselected.

10. UNOD

Enable the user to cancel the last selected operation before pressing the Apply button.

11. REDO

Enable the user to cancel the UNDO operation.

12. APPLY

Enable the user to execute the selected operation.

13. REMOVE ATT

Enable the user to remove current specified part properties.

14. SAVE

Enable the user to save the current part attributes to a file. A Select file dialog box will pop up and prompt the user to specify a name after clicking this button.

15. RECALL

Enable the user to load the previously saved part attribute file and set as the current parts attribute.

4.8. USER VIEW

This function is used to save the current viewing orientation and recall the previously saved view. User may save up to 10 views in a session. The program displays a control window as shown in Figure 4.13



Figure 4.13 User View control window

1. SAVE VIEW

Save the current viewing orientation. The program assigns a default view name as shown in Figure 4.14. User may enter any view name in the VIEW NAME field. Click OK to save the current viewing orientation, or click CANCEL to abort the save operation.

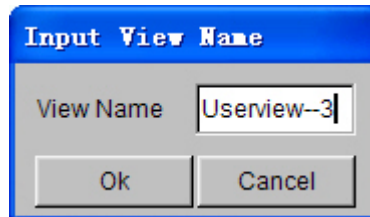

Figure 4.14 View Name control window

2. RECALL VIEW

Recall the previously saved viewing orientation. Click a VIEW NAME in the view list and then click RECALL. The program will display the model according to the viewing orientation saved under the selected VIEW NAME.

3. DELETE

Delete the previously saved viewing orientation. Click a VIEW NAME in the view list and then click DELETE to delete the saved view.

4. EXIT

Closes the SAVE VIEW control window and exits the function.

4.9. BACKGROUND COLOR

This function allows the user to select a color from color palette as the background color in the graphic display window. Once the function is selected, the program displays a color palette as shown in Figure 4.15



Figure 4.15 Background Color Palette

The user may select any color in the palette as the background color. The program will change the background color immediately and exit the function as the color is selected. Press the ESC key to exit the function without selecting any color.

5

TOOL

The functions in this menu are shown in Figure 5.1. The user can define section cut, mirror result, define active window, trace node and define node curve.

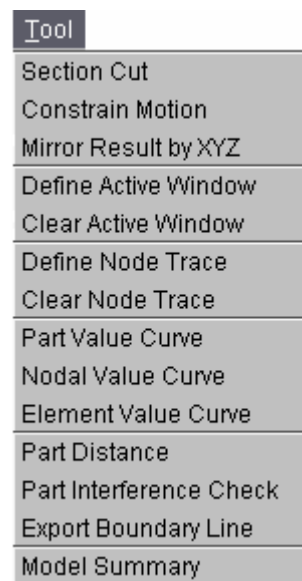

Figure 5.1 Tool Menu

A detailed description of each function and corresponding submenu is given in the following section.

5.1. SECTION CUT

This function displays the section cut of a finite element model with a defined plane intersecting the elements. The functions in SECTION CUT control window are shown in Figure 5.2. DEFINE CUT PLANE is the only function available when the SECTION CUT function starts.



Figure 5.2 Section Cut Operation

5.1.1. DEFINE CUT PLANE

The section plane is the U-V plane of the user defined local coordinate system. The local coordinate system may be defined by selecting one, two or three nodes from the model. The program displays a Control Option window as shown in Figure 5.3. The program also changes the displayed model to wire frame mode in gray color.

Control Option	
Coordinate	
X Value:	<input type="text"/>
Y Value:	<input type="text"/>
Z Value:	<input type="text"/>
Apply Input Value	
Select by Cursor	
W Along +X Axis	
W Along -X Axis	
W Along +Y Axis	
W Along -Y Axis	
W Along +Z Axis	
W Along -Z Axis	
Reject Last	
Exit	

Figure 5.3 Define Cut Plane

1. ONE POINT

Enter a X,Y,Z coordinate to the text box under Coordinate Group manually and then click Apply Input Value button Or select a node by cursor in graphic area to define the origin of the LCS, then select a global direction as the local W axis and click EXIT. The global direction may be either + or – X (Y or Z) axis as listed in Figure 5.1.2. The local coordinate system will be defined at the first node with the local W axes following the selected direction and U, V axes parallel to the other two global axes.

2. TWO POINTS

Enter a X,Y,Z coordinate to the text box under Coordinate Group manually and then click Apply Input Value button Select the first node to define the origin of the LCS and the second node to define the local W-axis, then click EXIT to define the LCS. The local coordinate system will be defined at the first node with local w-axis aligned with the vector connecting the first and the second node.

3. THREE POINTS

Enter a X,Y,Z coordinate to the text box under Coordinate Group manually and then click Apply

Input Value button Select the first node to define the origin of the LCS. Enter a X,Y,Z coordinate to the text box under Coordinate Group manually and then click Apply Input Value button select the second node to define the local U axis and the third node to define the U-V plane. The local V and W axis will be computed according to the right hand rule.

Once the local system is defined and accepted, the program will display the section lines in part color that represent the section cut of the model in the u-v plane. The program will activate other options as shown in Figure 5.4 for the user to change or operate the cut section.

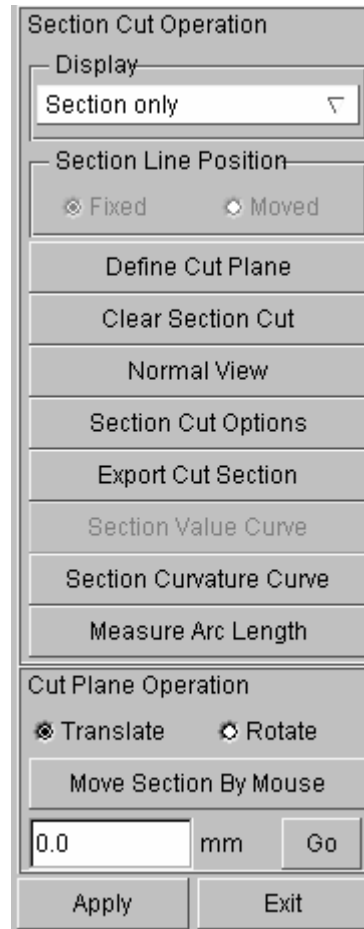

Figure 5.4 Section Cut Operation

5.1.2. CLEAR SECTION CUT

This function enables the user to erase the section cut from the display window.

5.1.3. NORMAL VIEW

This function enables the user to view from the normal direction of the cut plane.

5.1.4. SECTION CUT OPTIONS

This function controls the display and export of the section cut. Refer to Figure 5.5 for the available

options.

1. CUT PLANE

The default number of cut planes is 20 if ALL PLANE option is selected. This means there will be 20 cut planes equally spaced along the local W direction. If the CUR.PLANE is selected, the current section cut will be exported when select the function EXPORT SECTION CUT. If the ALL PLANE option is selected, all 20 section cuts will be exported when select the function EXPORT SECTION CUT.

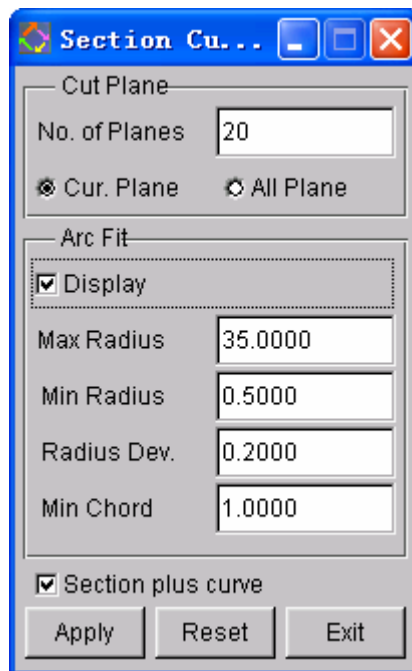

Figure 5.5 Section Cut Option

2. ARC FIT

This function will search and label all the arcs along the section line with the radius between the Max. Radius and the Min. Radius. If the DISPLAY is toggled on, the arcs labeled with radius will be displayed on the screen. The result of ARC FIT displays is shown in Figure 5.6.

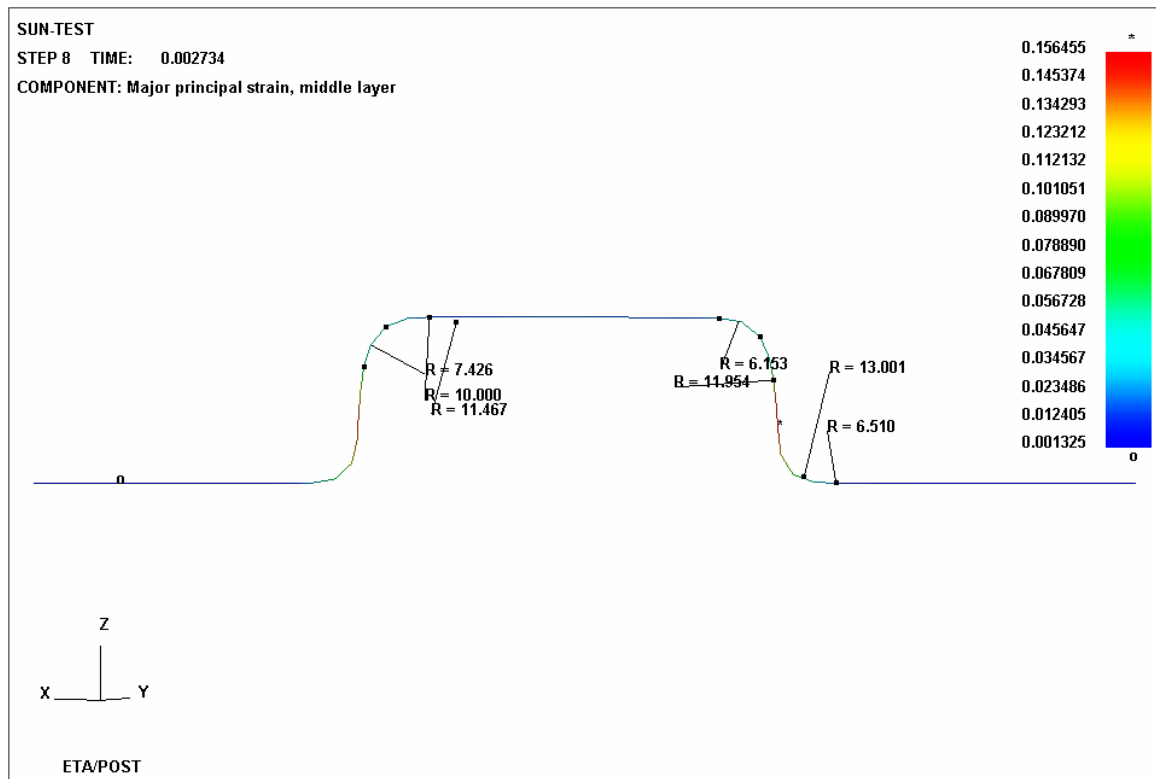

Figure 5.6 The result of ARC FIT

- MAX RADIUS

Set the maximum arc radius that can be displayed.

- MIN RADIUS

Set the minimum arc radius that can be displayed.

- RADIUS DEV.

Set the tolerance between two adjacent arcs to merge.

- MIN CHORD

Set the minimum chord length that can be displayed.

5.1.5. EXPORT SECTION CUT

This function allows the user to export all the section lines to a NASTRAN file. The number is controlled by Cut Plane group options as shown in Figure 5.5, The program displays a Select File dialog window as shown in Figure 5.7.

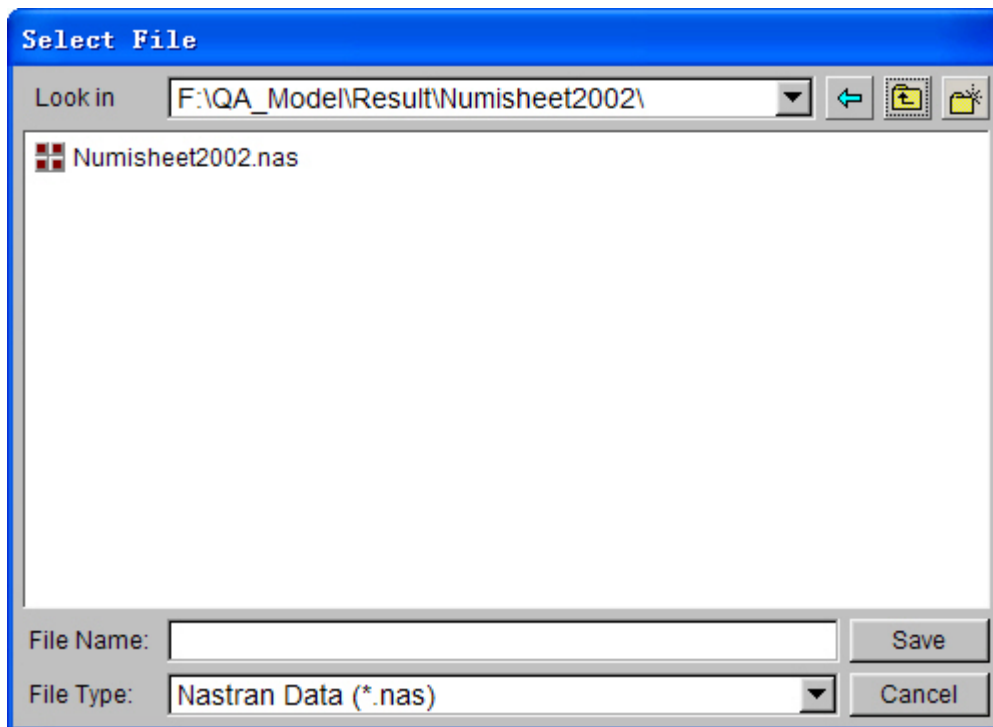

Figure 5.7 Export Nastran File

5.1.6. SECTION VALUE CURVE

This function is only enabled for the section cut in contour animation. Click SECTION VALUE CURVE to display a graph window containing the section curve. Refer to Figure 5.8 for a sample graph window. The abscissa is the arc length of the section and the ordinate is the corresponding contour value. Its zero point is correspondingly marked out in graphic area.

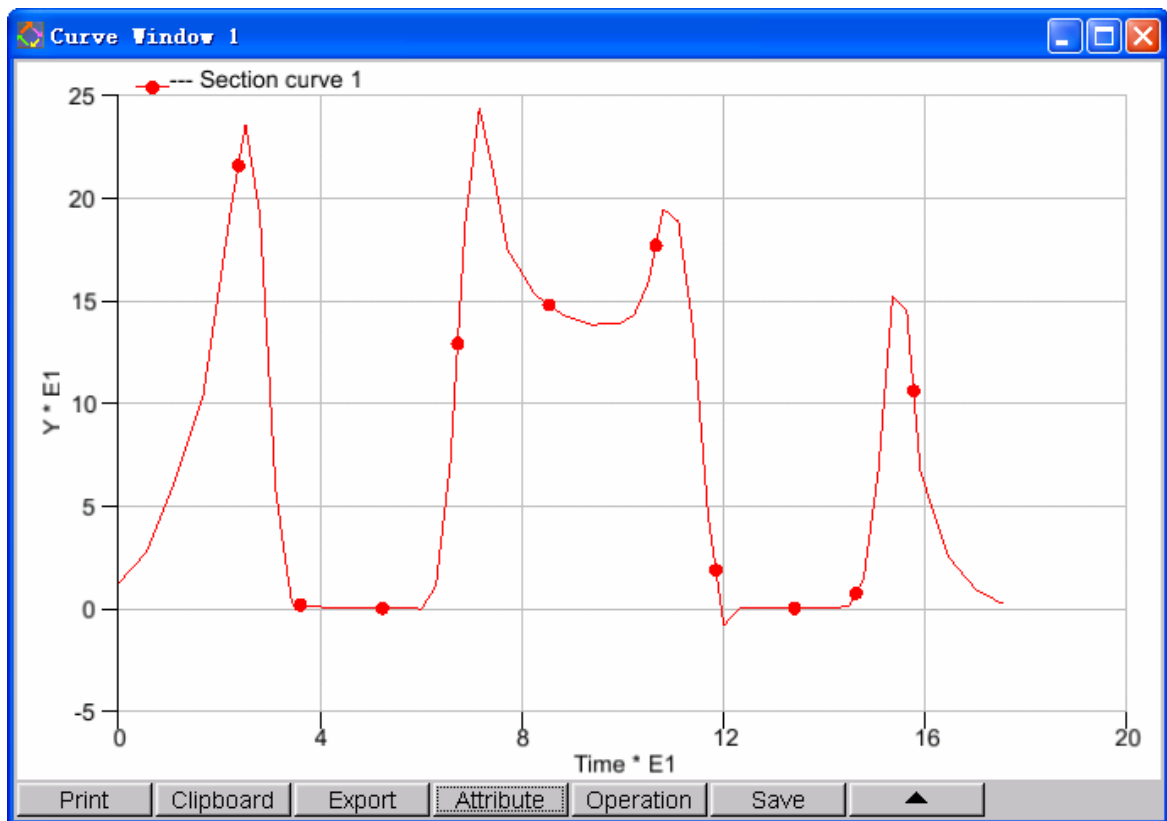

Figure 5.8 A Section plus curve window

5.1.7. SECTION CURVATURE CURVE

This function is used to display section curvature curve. Click SECTION CURVATURE CURVE to display graphic window that includes section curvature curve. See Figure 5.9. The abscissa is arc length of section curve and the ordinate is the corresponding curvature.

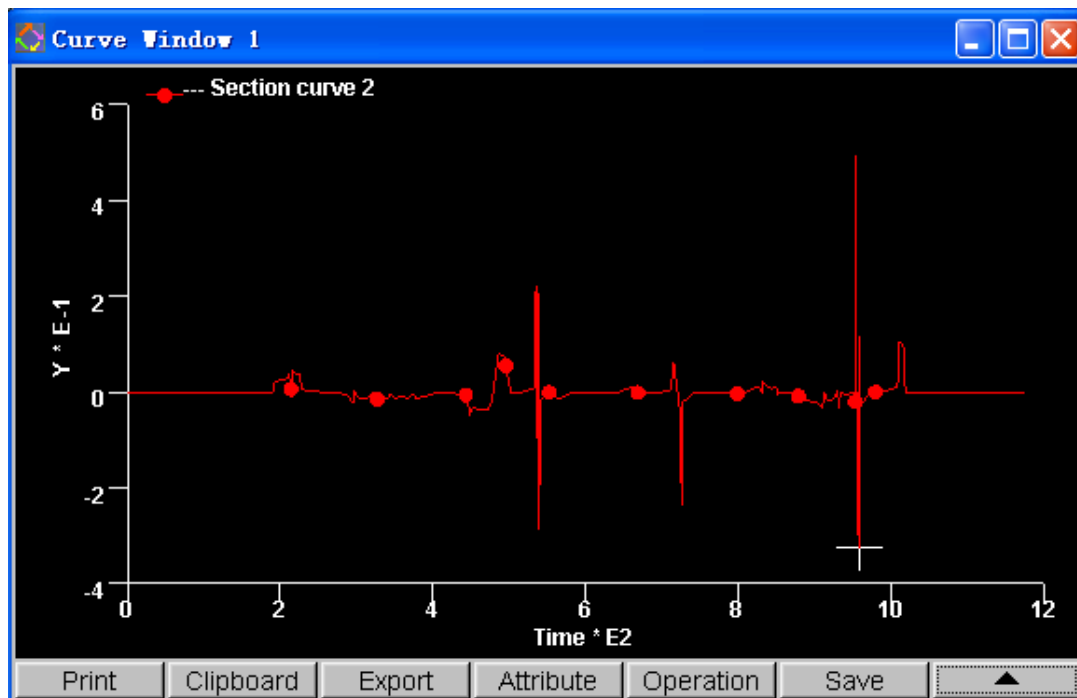

Figure 5.9 Section Curvature Curve

5.1.8. MEASURE ARC LENGTH

This function allows user to measure arc length of the same section line. User may left click mouse to select two nodes on any section line, selected nodes are marked with node number. When two nodes are selected, program displays arc length, highlight it on the screen and output relevant information in information window. See Figure 5.10.

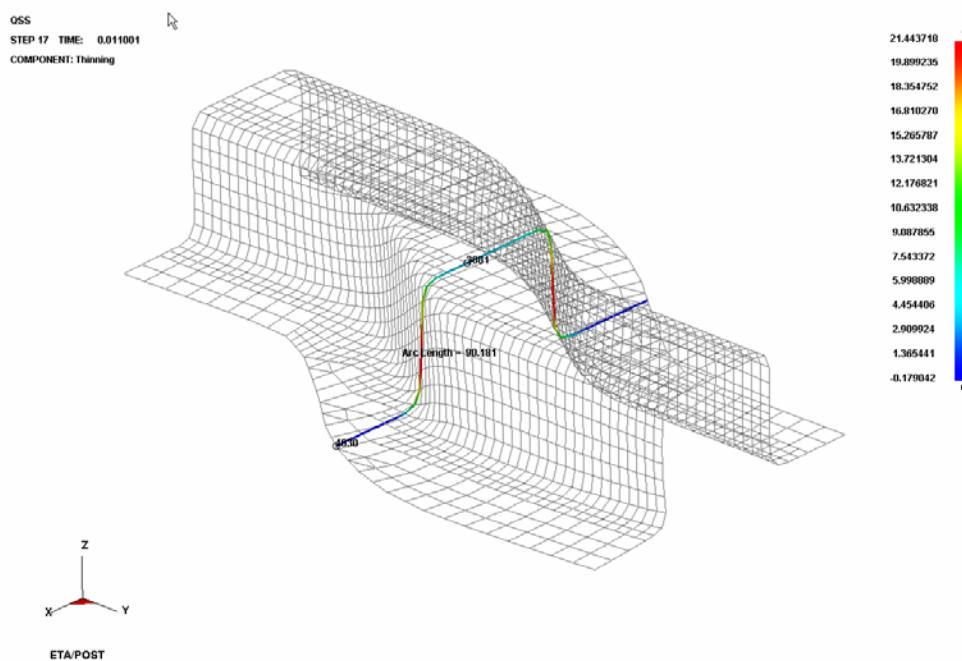

Figure 5.10 Measure Arc Length

5.1.9. MOVE SECTION BY MOUSE

This function allows the user to move the section cut location by using the mouse. The movement may be translation along the local W axis or rotation about the local W axis.

- TRANSLATE

Click the MOVE SECTION BY MOUSE option and click MOVE SECTION BY MOUSE. eta/Post displays a Control Window to allow the user to define the reference point. Click DEFINE REFERENCE POINT to select a node in the current section as the reference node. Or click PREVIOUS POINT to use the previously defined reference point. The program draws a line along the local W axis as the directional line. Move the mouse along the directional line to obtain the new section cut nearest the cursor. Click the left mouse button to accept the new section and exit the function.

- ROTATE

Click the MOVE SECTION BY MOUSE option and click MOVE SECTION BY MOUSE. eta/Post displays a Control Window to allow the user to define the rotational axis. Click DEFINE ROTATION AXIS to select two nodes in the current section as the W-Axis. Or click PREVIOUS AXIS to use the previously defined rotational axis. Move the mouse along the directional line to obtain the new section cut. Exit the Control Option to accept the U-Axis, at this time the user is allowed to drag mouse, the section cut will rotate along the U-Axis.

- MOVE OR ROTATE SECTION BY INPUTING DISPLACEMENT

This function allows user to input offset value to move section position. Displacement value is based on cutting section, enter offset value and click GO button. Section translates or rotates about defined local W-axis.

5.1.10. DISPLAY OPTIONS

- WHOLE MODEL

Whole model will be displayed after exit from the section cut menu.

- SECTION ONLY

Only the section line will be displayed after exit from the section cut menu. This option is the default display option when the user uses Section function.

- PARTIAL MODEL

This function allows user to display a portion of the model on the one side of the section line

after exit from the section cut menu. If this option is selected, the program will prompt the user to select the side about the section line. The program will display only the selected portion of the model on the screen. Figure 5.11 shows a typical display of PARTIAL MODEL option.

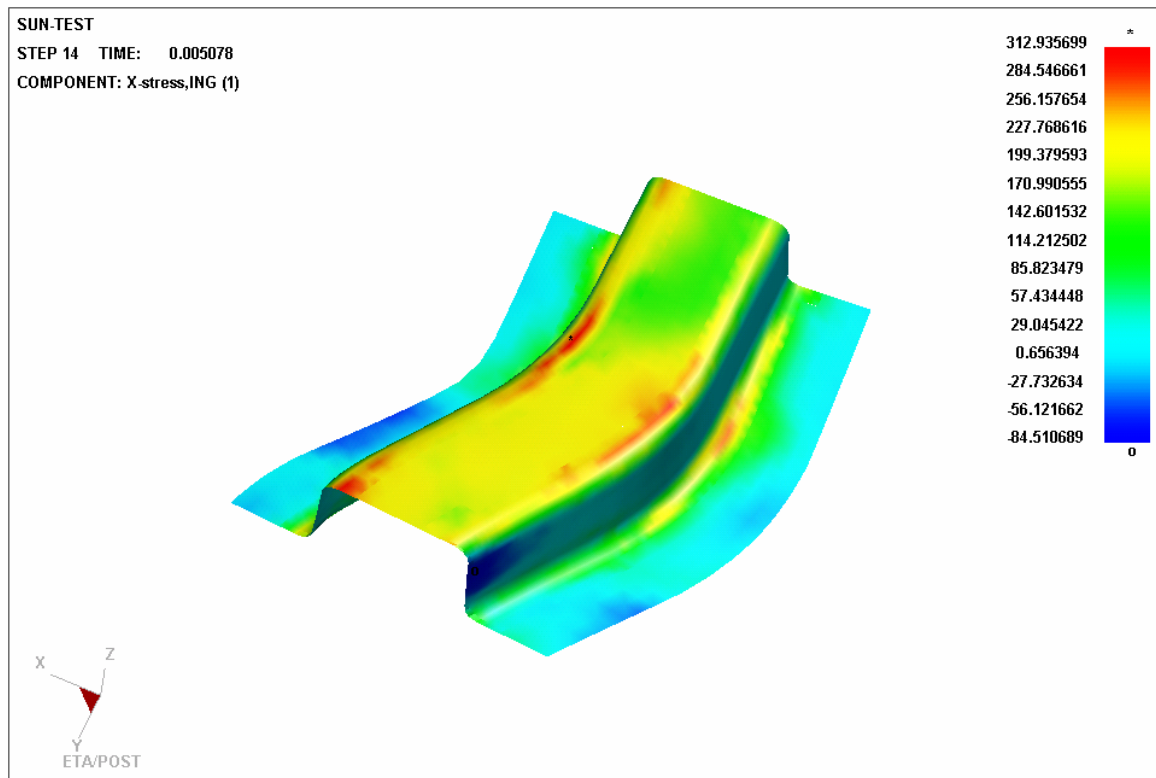

Figure 5.11 An Example for PARTIAL MODEL display

5.1.11. SECTION LINE POSITION

This function provides two options for the user to decide the section plane is fixed or moved.

- FIXED

If the user selects this option, the section cut plane is fixed. The section cut will be made from the model in each time step intersecting the fixed section plane. Depending on the relative movement between the model and the cut plane, the section cut pattern may be different between time steps as the model is passing through the section plane. The result shown in the section may be cut from different elements between time steps.

- MOVED

If the user selects this option, the section plane is moved with the model. The section cut is always made to the same elements intersecting the section plane between time steps. This will assure the result shown in the section is always cut from the same elements during the animation.

5.2. CONSTRAINT MOTION

This function enables the user to define a reference point for animation. The user may select any node in the model as the reference point by the function SELECT REFERENCE NODE. The user may also select any or all translation degree of freedom (X, Y and Z) to constrain the motion. Figure 5.12 shows the dialog window of the Constraint Motion.

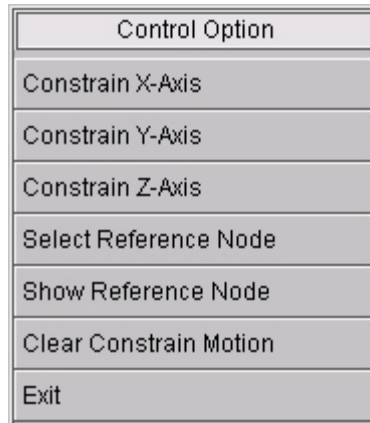

Figure 5.12 Constraint Motion Dialog Window

The referenced node will be stationary in the constrained direction during the animation. The rest of the model will be displaced relative to the reference node.

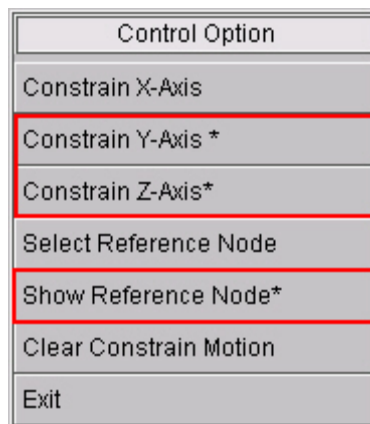

Figure 5.13 Constraint Motion Dialog Window

Note: When Axis is selected as the constraint axis, the function will be labeled with asterisk as shown in Figure 5.13 . When Show Reference Node is clicked, the function will be labeled with asterisk. The program labels the reference node with a circle during animation.

5.3. MIRROR RESULT BY XYZ

This function allows the user to define a plane to mirror the analysis result. Three mirror planes are available: XY PLANE, YZ PLANE and ZX PLANE as shown in Figure 5.14.

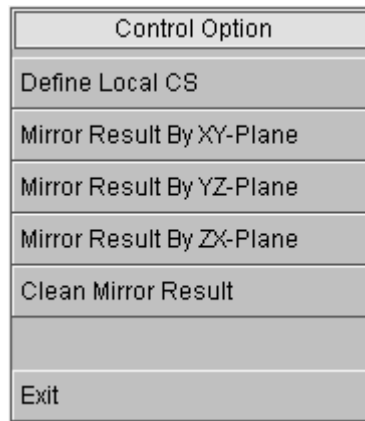

Figure 5.14 Mirror Result Control Option Window

The following example is to mirror a quarter model and result as shown in Figure 5.15. After selecting MIRROR RESULT BY YZ PLANE, the program mirrors the model and result as shown in Figure 5.16.

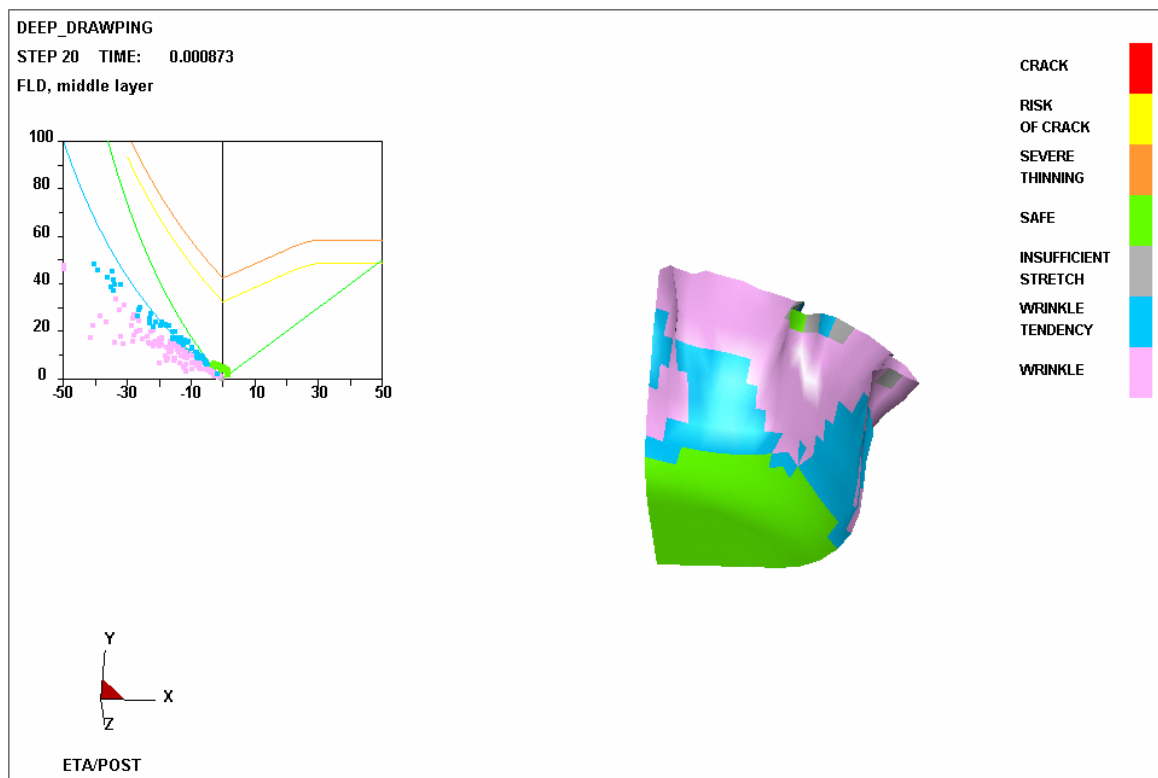

Figure 5.15 Example of a quarter model and result

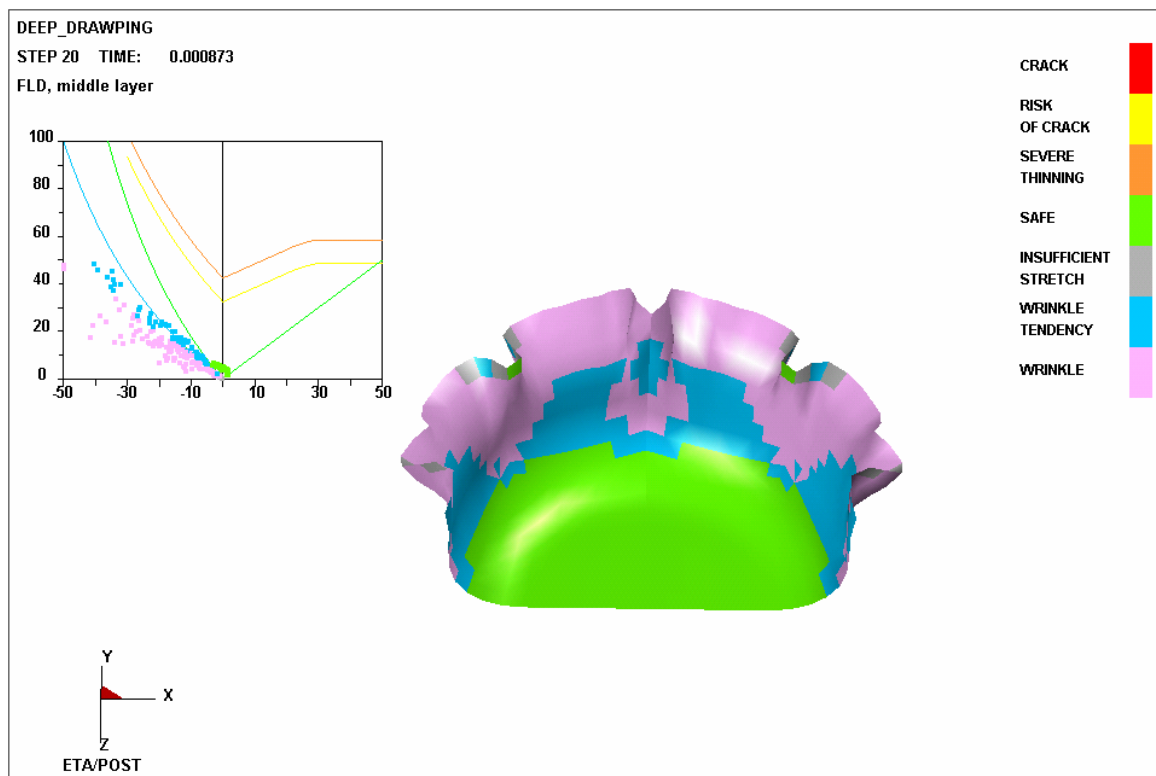

Figure 5.16 Mirrored model and result by YZ Plane

Press the CLEAN MIRROR RESULT in the Control Option Window to remove the mirrored model and result.

- DEFINE LOCAL CS

This function is used to mirror the model based on local UVW plane. Process of Define Local CS is the same with Define Cut Plane. See DEFINE CUT PLANE in chapter 5.1.

5.4. FACE REFLECTION LINE CHECK

This function simulates reflection model irradiated by several tubular light sources which are parallel distributed on one plane. Formed strips as zebra pattern on the model face are used for examine leveling of the surface.

Control Window is as Figure 5.17. After entering this function, strip automatically maps on the model surface. Original light source plane is the global X-Y plane. The reference point of the plane locates on Z axis direction in the center of the model. Light source width and space are automatically set according to the model size. User may adjust the amount, direction, width and space of light source to achieve different examination goals. The examination result is show as Figure 5.18. Strips are distributed more straightforward and even on smooth region of the model. In scraggly region of the model, strips are distorted and are distributed uneven. The degree of distortion is direct ratio to the degree of the scragginess.

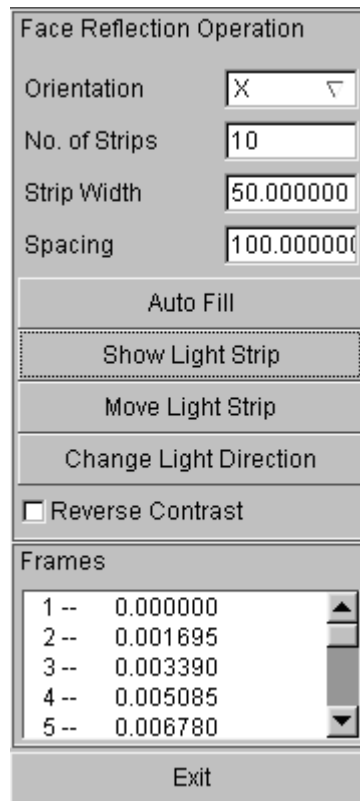

Figure 5.17 Face Reflection Control Window

1. LIGHT SOURCE PARAMETERS

- ORIENTATION

Setup light source orientation. There are X, Y and User Defined options. Default setting is X. X and Y indicates light tube axis orientation is set at global X and Y direction. After selecting User Defined, user may drag mouse to rotate light tube in its plane, left click or right click mouse to confirm and exit.

- NO.OF STRIPS

Setup number of strips, default number is 10.

- STRIP WIDTH

Setup strip width.

- SPACING

Setup strip spacing.

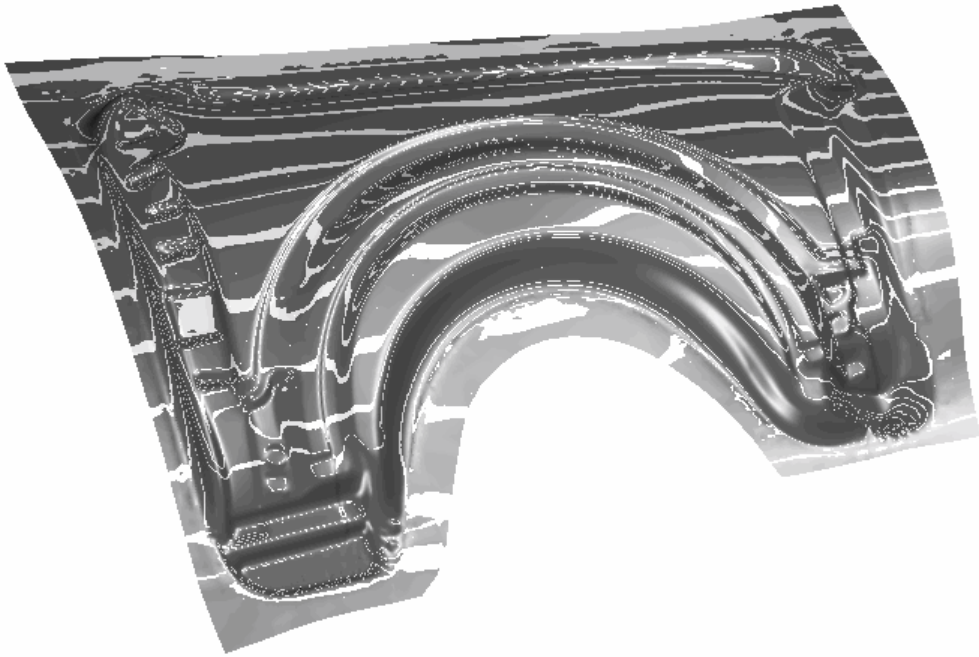

Figure 5.18 Face Reflect Examination Result

2. STRIP CONTROL

- **AUTO FILL**

Select this function to automatically reset strip width and spacing according to the current model size and light tube plane position to make strips filled on the model.

- **SHOW LIGHT STRIP**

Select this function to force re-plotting the current examination result.

- **MOVE LIGHT STRIP**

Select this function, user can move mouse to move light strip, left click or right click mouse to confirm and exit.

- **CHANGE LIGHT DIRECTION**

Select this function to rotate the light source plane, the normal direction of the light source plane will dynamically rotate around the axis of the light source when the cursor is moved up or down, and the rotate center is the model center. Left click or right click mouse to confirm the result and exit. If the main part of model is not located on the global X-Y plane, user may use this function to adjust the light source plane to a suitable position.

- REVERSE CONTRAST

Select this function to reverse the color of the light and shade region.

3. FRAME

List all frames information of the current model. If user clicks one frame, then program re-plots strips result according to data of this frame.

4. EXIT

Exit the function.

5.5. DEFINE ACTIVE WINDOW

This function allows the user to display a portion of the model for more detailed viewing. The user defines the desired area. eta/Post displays the elements with the analysis result as active window. Other portion of the model will be masked and became inactive.

The user can define the Active Window by Cursor, Drag Window, Polygon Freehand and Displayed. Or can use Undo, Redo, Clear Active Window to reset active window. See the Control Option shown in Figure 5.19. After define, click Exit to quite Define Active Window.



Figure 5.19 Define Active Window Control Window

Click CLEAR ACTIVE WINDOW from the TOOL Pull-down menu to remove the defined active window. The program will display the whole model.

5.6. DEFINE NODE TRACE

NODE TRACING allows the user to select a set of nodes to be traced during animation. Dialogue box shown in Figure 5.19 prompts user to select node. A trace is a line or track that shows the path that the node takes during the animation. A typical Node Trace is show in Figure 5.21.

Control Option
Select by Cursor
Select by Window
Select by Polygon
Select by Freehand
Select by Displayed
Select by Part Name
Reject Last Selected
Redo
Abort Selected
Exit

Figure 5.20 Select Node Control Window

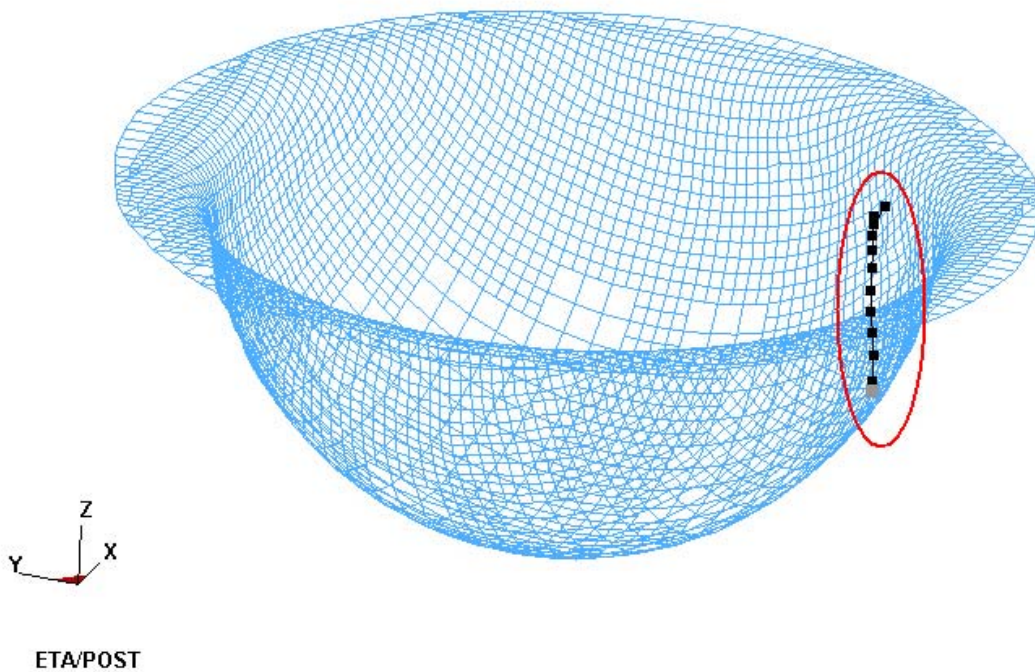

Figure 5.21 The Node Trace

Click the CLEAR NODE TRACE from the TOOL Pull-down menu to remove all of the currently defined traces.

5.7. PART VALUE CURVE

This function allows the user to plot the result of the selected parts. The program shows the time change curve of the maximum and minimum value in the selected parts in a time history curve in a graph window. The function only works in contour animation. The program displays a dialog window as shown in Figure 5.22 and prompts the user to select the desired parts. Figure 5.23 shows a typical Part Value Curve of thickness animation.

Note: The user should select the formed part (blank) as the tool parts don't have results.



Figure 5.22 Select Part Control Option

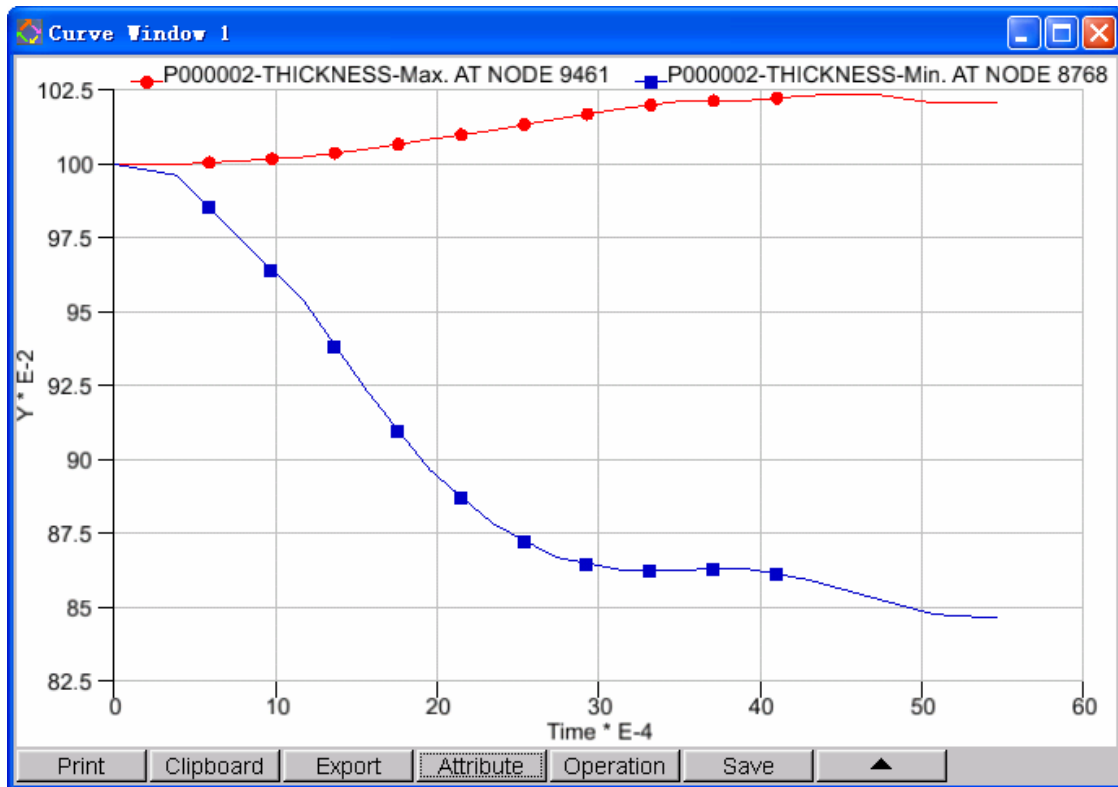

Figure 5.23 A typical Part value curve

5.8. NODAL VALUE CURVE

This function allows the user to plot the result in a time history curve of the selected nodes in a new graph window. The dialogue box see Figure 5.24. This function is only activated in contour animation. After selecting desired nodes, the program shows the node curve result as shown in Figure 5.25.



Figure 5.24 Select Node Control Window

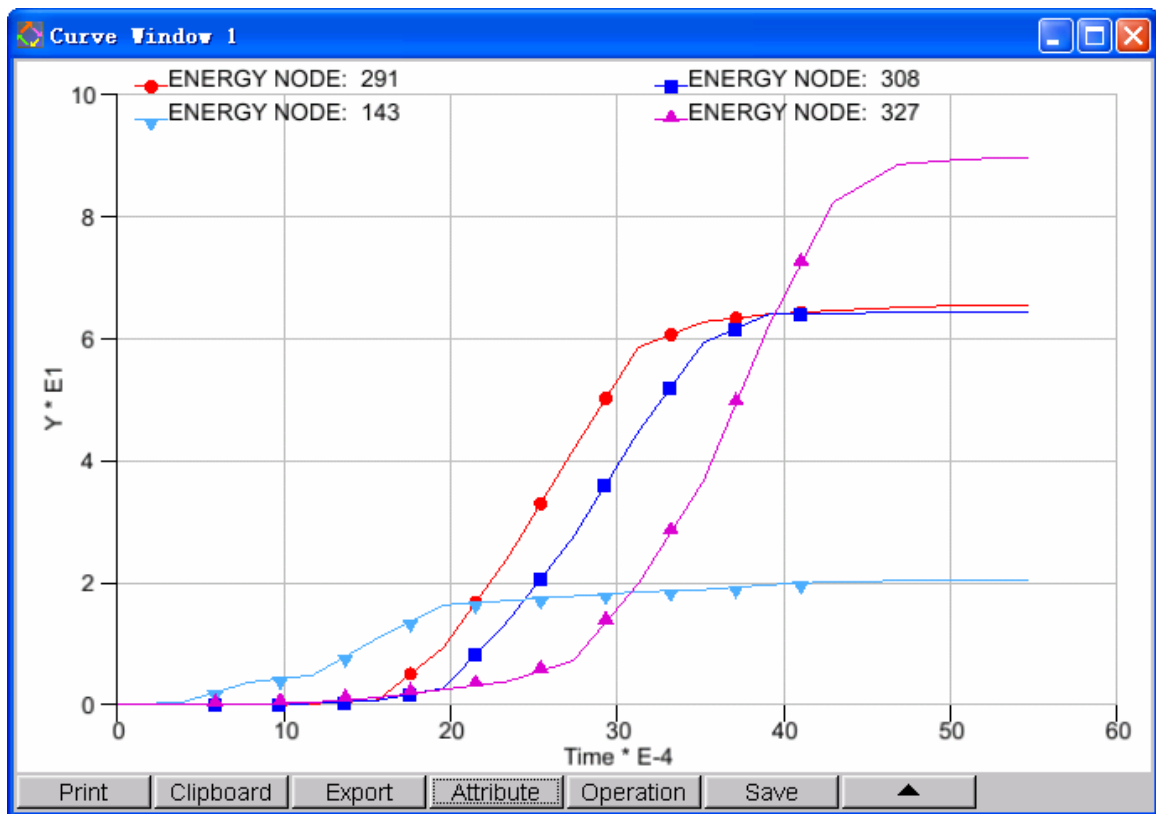

Figure 5.25 Node Curve Result

5.9. ELEMENT VALUE CURVE

This function allows the user to plot the result of the selected elements in a time history curve in a new graph window. The function only works during contour mode with ELEMENT RESULT options selected. The procedure of using the function is same as NODAL VALUE CURVE as described in Section 5.8. Figure 5.26 shows a typical Element Value Curve.

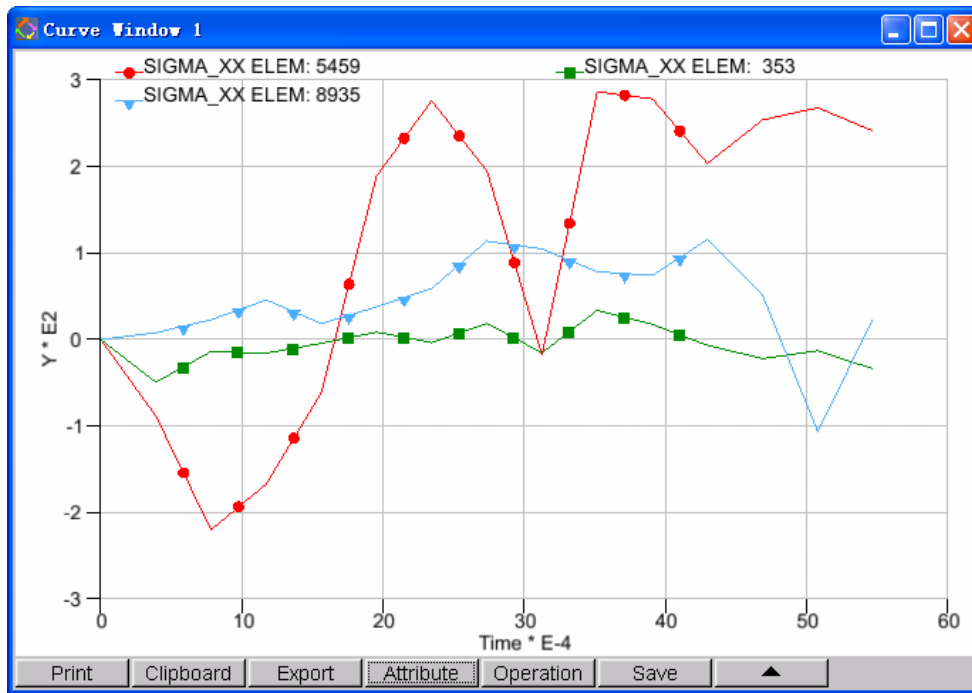

Figure 5.26 A sample of ELEMENT VALUE CURVE

5.10. NODAL DISPLACEMENT CURVE

This function helps user to draw nodal displacement curve of the selected nodes. User may select multiple displacement components at the same time. The dialogue box is as Figure 5.27. After selecting desired nodes, program plots nodal displacement curve in the new curve window. See Figure 5.28.



Figure 5.27 User Select Control Window

Displacement component curves with (*) in Figure 5.27 are drawn at the same time. Default setting is to display 3 displacement components and global displacement. Click any one of the components to toggle off it, click once more time to toggle on it.

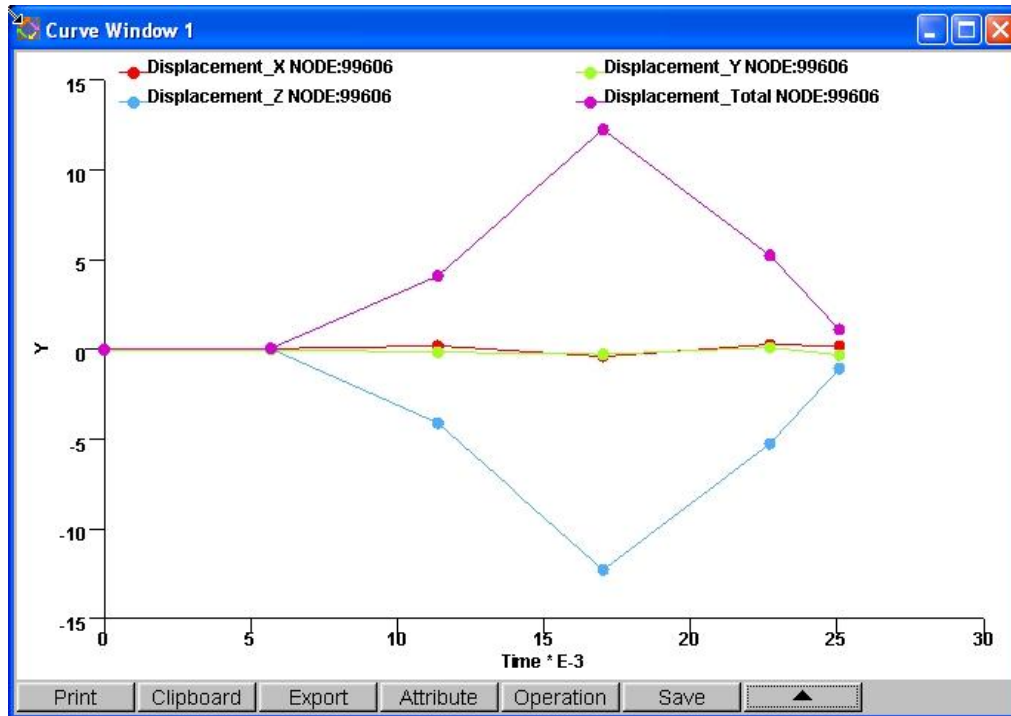

Figure 5.28 Nodal Displacement Curve Example

5.11. PART DISTANCE

This function is used to calculate the distance between two parts and plots the result in contour. Figure 5.29 is control window. User needs to set Source part and Destination part. The calculation result plots on the Source part.

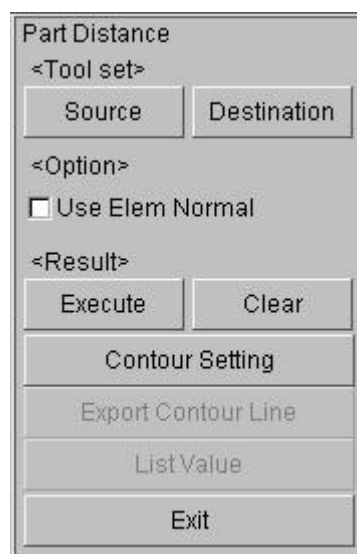

Figure 5.29 User Control Window

1. TOOL SET

● SOURCE

Select source part for distance calculation.

● DESTINATION

Select destination part for distance calculation.

2. OPTION

● USE ELEM NORMAL

if toggle off this option, calculated distance is a absolute value between the elements. If toggle on this option, calculated distance considering the normal direction of two parts. The distance value can be positive or negative. Figure 5.30 shows the result when the option is off while Figure 5.31 shows the result when the option is on.

3. RESULT

● EXECUTE

Calculates the distance between two parts and plots the contour result.

● CLEAR

Clears calculated contour result.

4. Exit

Exit this function.

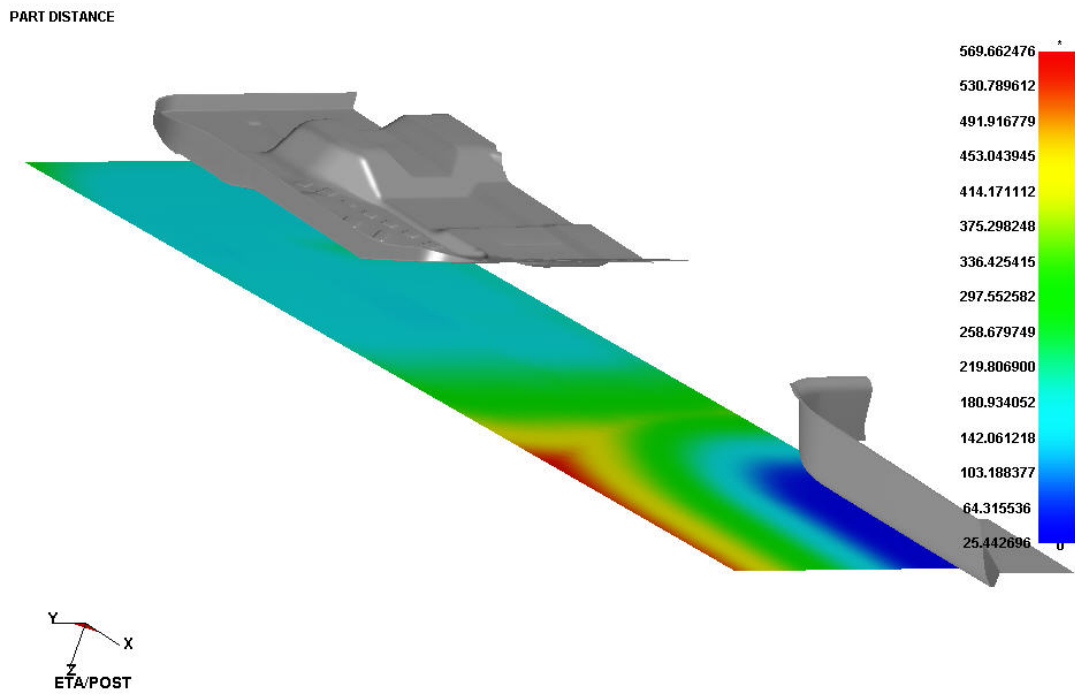

Figure 5.30 Calculation Result When the Option is off

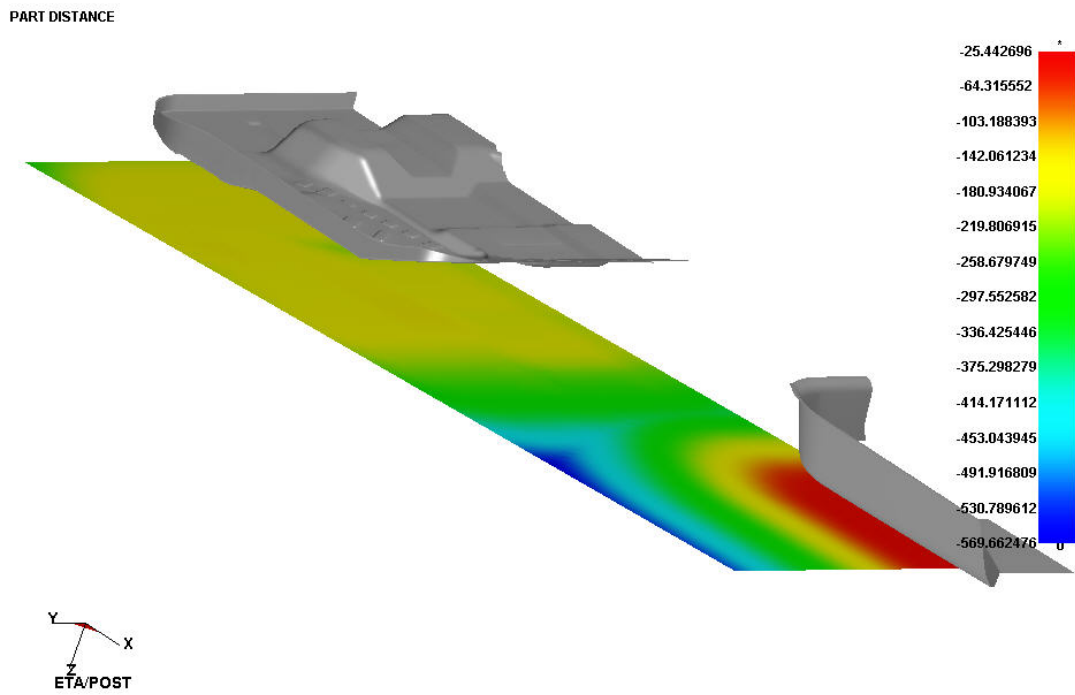

Figure 5.31 Calculation Result when the Option is on

5.12. PART INTERFERENCE CHECK

It is used to examine the interference status between parts. Figure 5.32 is Control Window.

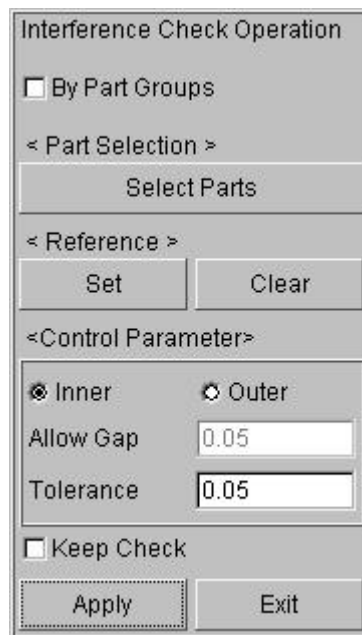

Figure 5.32 User Control Window

1. BY PART GROUPS

When selecting the option, user needs to specify master part group and slave part group. This function is used to check the interference status between two part groups and there is no checking of interference status of parts within part groups. When the option is not selected, user may select any parts, this function is used to examine the interference status between any two parts.

2. REFERENCE

Under some cases, initial model has interference in itself, and user may need to ignore or hold this interference.

- SET

Throw off the interference of initial model from the current interference result.

- CLEAR

Calculate all interference result without considering initial model interference in the current step.

3. CONTROL PARAMETERS

- INNER

When selecting this option, this function is used to check if there is penetrable interference between part elements.

- OUTER

When selecting this option, this function is used to check if there is contact interference between part elements.

- ALLOW GAP

This option is only used for outer interference. The value is maximum allowable gap criterion to distinguish the contact interference.

- TOLERANCE

It is used to control calculation accuracy.

4. CONSTANT INTERFERENCE CHECK

- KEPP CHECK

After selecting this option, program keep checking interference when plotting each frame during animation. It is mainly used in animation, the animation stops automatically every time interference is checked out.

5.13. EXPORT BOUNDARY LINE

This function helps user to export boundary line of part to file. The dialogue is shown as Figure 5.33. Click Select parts to select parts, and then click exports boundary lines to export the boundary line. Set file path and name in the following opened dialogue box. (the file format of boundary line file is Line Data).



Figure 5.33 Export Boundary Line dialog window

5.14. MODEL SUMMARY

This function enables the user to display the statistics regarding elements and nodes in the model. Figure 5.34 shows a sample model summary.

Model Summary	
Number of Parts:	4
Number of Elems:	2488
Number of Nodes:	2622
Max Elem No.:	2703
Max Node No.:	2730
Beams :	0
Tri Plates :	144
Quad Plates :	2344
Hexahedrons :	0
Wedges :	0
Tetras :	0
Exit	

Figure 5.34 Model Summary

6

OPTION

The functions in this menu are shown in Figure 6.1. The user can customize the appearance in the graphic display window.

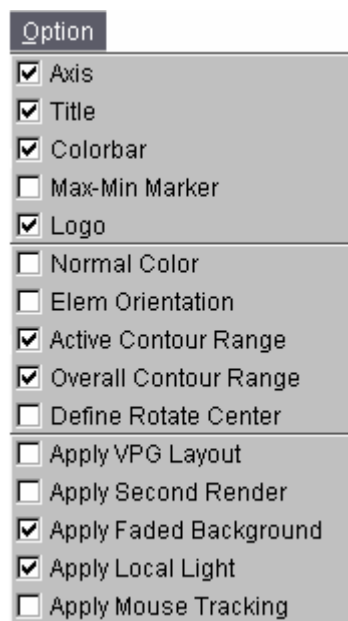

Figure 6.1 Tool Menu

A detailed description of each option is given in the following section.

6.1. AXIS (toggle)

The XYZ coordinate system is displayed in the lower left corner of the display window. This option allows the user to toggle the axes on/off.

6.2. TITLE (toggle)

The title of the result file is displayed in the upper left corner of the display window. This option allows the user to toggle the title on/off.

6.3. COLOR BAR(toggle)

This function toggles the color gauge at the right corner of screen on and off.

6.4. MAX-MIN MARKER (toggle)

This option is used to control marked physical valute in screen graphic area. Normally use * to represent the max value and use o to represent the min value.

6.5. LOGO

This function toggles the Company Logo(eta) at the lower left corner of screen on and off.

6.6. NORMAL COLOR (toggle)

This option allows the user to display the part color on positive side and gray color on the negative side of the finite element model when PLATE NORMAL option is selected in the DISPLAY OPTIONS window. This option is essential for the user to visually check the part for reversed normal of the finite element mesh. Figure 6.2 shows a part displayed with NORMAL COLOR and PLATE NORMAL option.

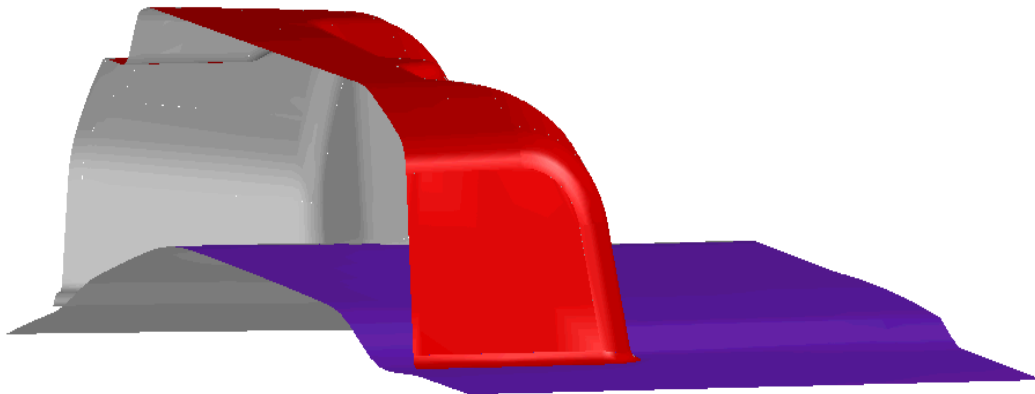

Figure 6.2 Typical display with Normal Color and Plate Normal option

6.7. ELEMENT ORIENTATION (toggle)

This option shows a vector from the first node to the second node of each plate element. It allows the user to visualize the direction of the element location U axis and local Z axis (according to the right hand rule) . It is useful to check the orientation of the composite material. Figure 6.3 shows a typical display of a part with ELEMENT ORIENTATION option.

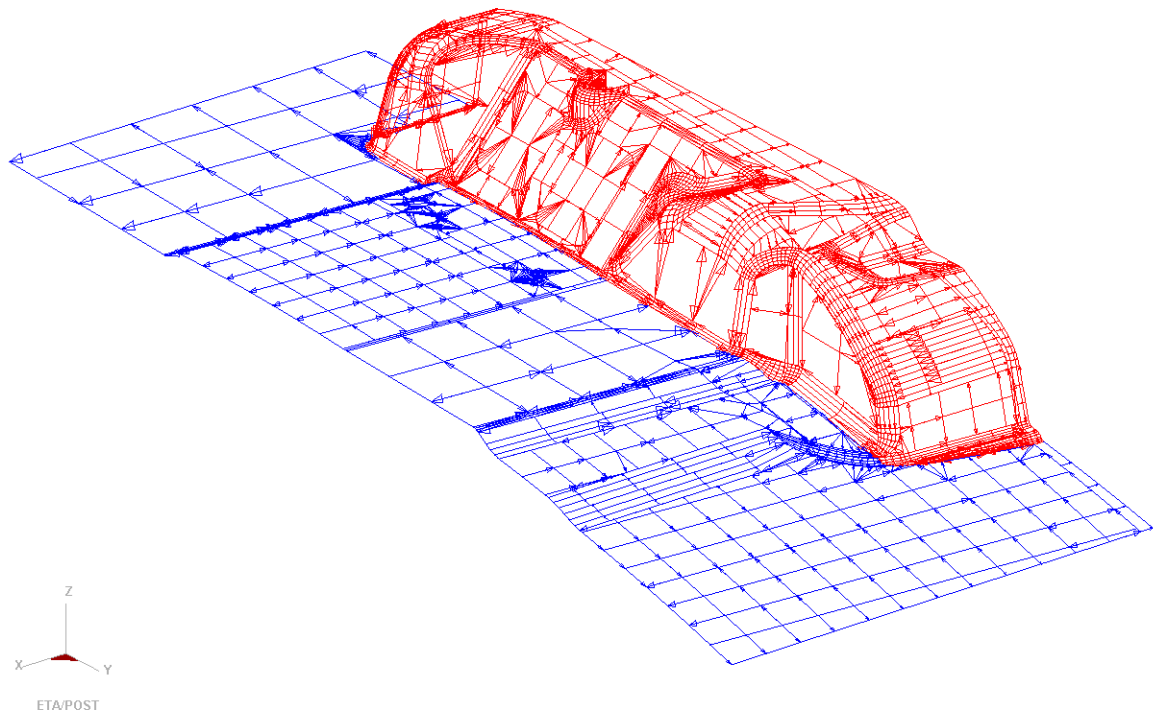

Figure 6.3 Typical display with Element Orientation option

6.8. ACTIVE CONTOUR RANGE

When this function is selected, the contour scope in color gauge changes according to part scope in graphic display area. When the function is not selected, the contour scope is the whole model scope, which is the displayed parts in graphic area.

6.9. OVERALL CONTOUR RANGE

When selecting this function, the contour scope in color bar is all frame scope. When the function is not selected, the contour scope in color bar is only the current frame scope.

6.10. DEFINE ROTATE CENTER

When this function is selected, user can define rotation center. When the function is not selected, program automatically define rotation center.

6.11. APPLY VPG LAYOUT

eta/POST supports several post processor software, such as DYNAFORM, VPG, etc at the same time. Default layout is DYNAFORM interface layout. When selecting this option, eta/POST interface layout adopts VPG post processor interface layout.

6.12. APPLY SECOND SHADING

When some graphic cards cannot work properly, this option is required to apply second shading. Under general situation, this function is not necessary.

6.13. APPLY FADED BACKGROUND

When selecting this option, morphing color is adopted as the background. When it is not selected, background is single color.

6.14. APPLY LOCAL LIGHT

When this option is selected, local light source is selected. Or to click SHIFT and left button of mouse at the same time to adjust the positions of two local light sources. Otherwise global light source is adopted. At this time click shift button and left button of mouse at the same time to adjust global light source direction.

6.15. APPLY MOUSE TRACKING

When selecting this option, eta/post can list value of elements or nodes that are corresponding to displayed cursor position.

7

POSTPROCESS

The functions in the POSTPROCESS menu allow the user to graphically display and manipulate analysis results. There are 4 functions shown in the post-processing tool bar as shown in Figure 7.1a and 11 special functions for eta DYNIFORM as shown in Figure 7.1.b.



a) General Post-process function icons

b) The special icons for eta/DYNIFORM

Figure 7.1 Post-process functional icons.

Once a function in the tool bar is selected, the POST-PROCESSING CONTROL WINDOW appears. Each function allows the user to graphically display and manipulate a specific result for stamping simulation. The user selects the desired PLOT STATE, TIME STEPS, FRAME RANGE and COMPONENTS to plot or animate the result.

Note: *To load LS-DYNA result files and to activate the post process menu, see FILE/OPEN in Chapter 3 FILE MANAGER.*

Note: *The user will not have access to have the control window when other control option windows are active.*

A detailed description of each function is given in the following sections.

GENERAL POST-PROCESS FUNCTION ICONS

The post-process function icons are always displaying on the icon bar of Post-Processor after the user load the result files from LS-DYNA or NASTRAN. These are common functions for most finite element analyses.

7.1. UNDEFORM

This function is used to display the un-deform model shape.

7.2. DEFORM

The functions in this menu animate the deformed shape of the model in real time and display displacement of an individual step. The options are shown in Figure 7.2.

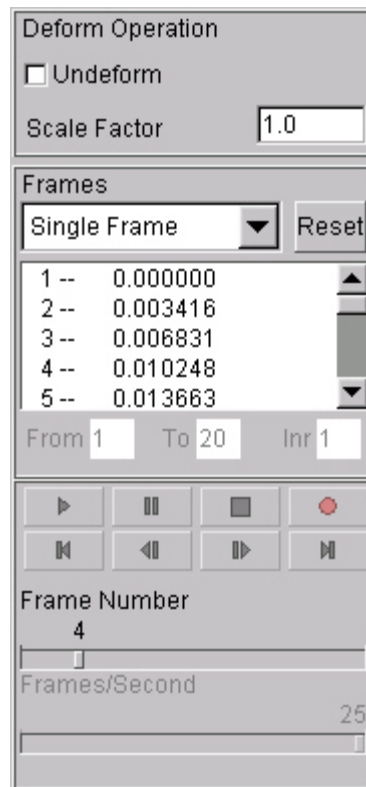

Figure 7.2 Deform control window

7.2.1. DEFORM OPERATION

1. SHOW UNDEFORM SHAPE

This function enables user to toggle the undeformed geometry of the model on/off. The deformed

shape plot is displayed in its original colour. The plot of the undeformed shape is displayed in white over the deformed shape.

2. SCALE FACTOR

This command adjusts the default scale factor of the deformed shape plot. The default is 1.

It scales plot components to a user-defined value allowing the user to magnify or minimize their visual display. For example, if the plot state is set to deformation, the user could magnify the deformation by a factor of ten to see small deformation not readily visible during animation.

7.2.2. FRAME OPERATION

This function allows the user to select desired frame(s) to plot (single frame) or animate (more than one frame) deformation shown as in Figure 7.3. There are 6 options in it.

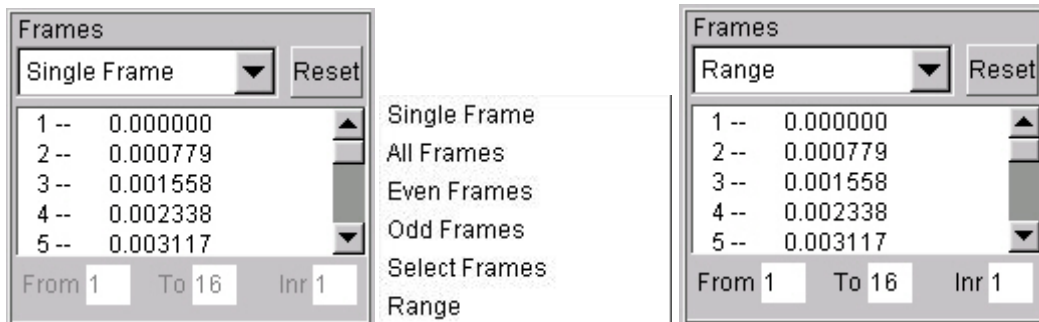

Figure 7.3 Frames Operations

1. FRAMES

The FRAMES window allows the user to select individual frame(s) for the plot or animation. The frames selected are highlighted in blue. When frames are selected in other options, the corresponding frames are highlighted in the FRAME window.

- SINGLE FRAME

This function allows user to pick single frame, and eta/Post plots the deformation simultaneously.

- ALL FRAMES

Once All Frames is picked, all frames in the list window are selected for animation.

- EVEN FRAMES

Once Even Frames is picked, even frames in the list window are selected for animation.

- ODD FRAMES

Once Odd Frames is picked, odd frames in the list window are selected for animation.

- SELECT FRAMES

Once Select Frames is picked, eta/Post allows user to select any frames for animation. Left mouse button picking works with CTRL and SHIFT to allow the user to select any desired frames in the list window.

- RANGE

The RANGE window provides the to user multiple options for determining the frames to be animated as shown in Figure 7.3. The RANGE option allows the user to define a range of frames with an increment. The data field for the RANGE option is not accessible until the option is selected.

After entering the desired values, press ENTER to activate the PLAY  button.

2. RESET

This function clears all previously selected frames.

7.2.3. ANIMATION OPERATION

This function allows the user to animate the selected frames as shown in Figure 7.4

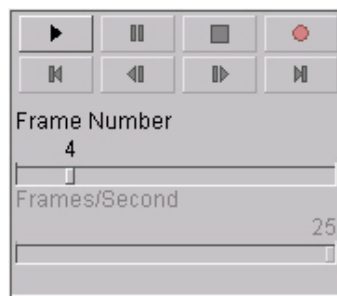

Figure 7.4 Animate

1. PLAY

eta/Post starts to animate the selected frames. After clicking the PLAY button, the other three buttons, PAUSE, STOP and EXPORT are activated as shown in Figure 7.5.

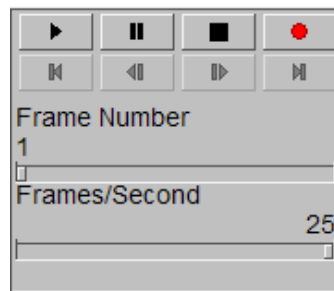

Figure 7.5 Play Status

2. PAUSE 

Pause the animation. In this mode, the four other functions are enabled to use as shown in Figure 7.6.

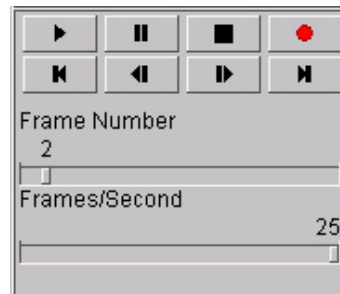

Figure 7.6 Pause Status

3. FIRST FRAME 

Display the first frame

4. PREVIOUS FRAME 

Display the previous frame

5. NEXT FRAME 

Display the next frame

6. LAST FRAME 

Display the end frame

7. STOP 

Stop the animation.

8. WRITE MOVIE FILE 

This function writes an AVI file or a E3D file from the current animation. An AVI file is a Microsoft multimedia file that provides a means to store a series of 2D images for animation. An E3D file is an ETA proprietary file that provides a means to store the true 3D images that can be played by eta/3D Player.

During Animation, click the WRITE MOVIE FILE  button. Eta/Post displays the WRITE FILE window for the user to choose the file type and enter the name and location for the file. Select AVI video (*.avi) or E3D Player file (*.e3d) as the file type, enter a file name and navigate to the desirable directory. Default directory is where the d3plot files are loaded.

After entering the name and location of the file, click the SAVE button in the WRITE FILE window. For AVI file type, eta/Post displays the SELECT COMPRESSION FORMAT for the user to select the compression type and quality.

The program writes the AVI or E3D file for the current animation.

9. FRAME NUMBER

After the animation is paused, this function allows the user to drag the slider to the desired frame to display the result.

During animation, the frame number is changed automatically according to the current time step.

10. FRAMES/SECOND

This function allows user to adjust the speed at which the animation is running by altering the number of frames per second. The user can drag the slider to adjust the frame rate. Once the frame rate is selected, the animation will continue at this frame rate until it is reset or stopped.

7.3. CONTOUR



The functions in this menu enable the user to animate the element stress/strain and related results in real time. The color bar, located on right hand side of graphic window, displays the corresponding contour values. The location of the highest contour value in the model is labeled with an asterisk (*) and the lowest is labeled with a zero (0). The functions in this menu are shown in Figure 7.7 Select Stress-Strain or Displacement in Contour Operation firstly, and then select Current Component to operate. The operation process is shown as follow.

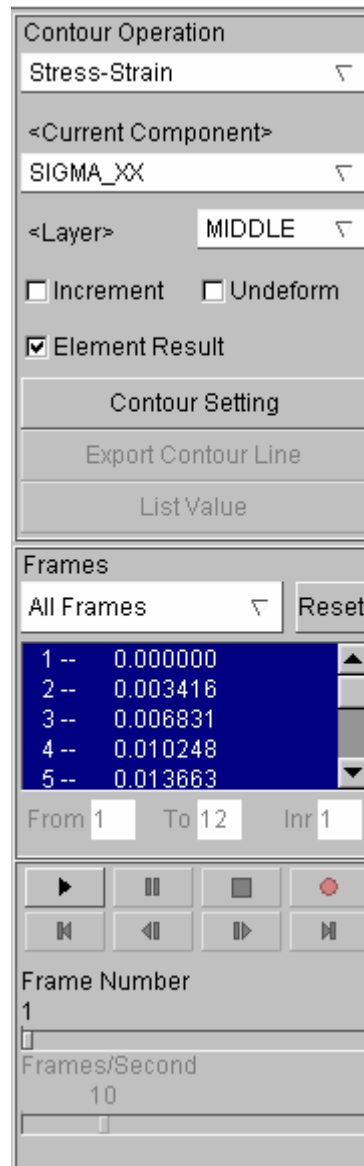

Figure 7.7 Animate Contour control window

7.3.1. SELECT COMPONENT

The contour animation can show STRESS/STRAIN and DSIPALCEMENT results. The user selects the type of contour variable displayed during the plot/animation. The selected type of variable determines the components displayed in the CURRENT COMPONENT drop down list.

SIGMA_XX	PRIN_STRESS2
SIGMA_YY	PRIN_STRESS3
SIGMA_ZZ	MAX_SHEAR_STRESS
SIGMA_XY	PRIN_STRAIN1
SIGMA_YZ	PRIN_STRAIN2

SIGMA_ZX	THINNING
PLASTIC_STN	NORM_STRAIN
BEND_MONMENT_MXX	EPSON_ZZ
BEND_MONMENT_MYY	EPSON_XX
BEND_MONMENT_MZZ	EPSON_YY
SHEAR_RES_QXX	EPSON_XY
SHEAR_RES_QYY	EPSON_YZ
NORMAL_RES_NXX	EPSON_ZX
NORMAL_RES_NYY	ENERGY
NORMAL_RES_NXY	MAX_VONMISES
THICKNESS	MEAN_STRESS
EPSON_XY	PRIN_STRESS1
EPSON_YZ	PRIN_STRESS2
EPSON_ZX	MEAN_STRESS
ENERGY	PRIN_STRESS1
MAX_VONMISES	PRIN_STRESS2
MEAN_STRESS	PRIN_STRESS3
PRIN_STRESS1	

If the DISPALCEMENT type is selected, the supported components are listed below:

DISPLACEMENT_X	VELOCITY_Z
DISPLACEMENT_Y	VELOCITY_TOTAL
DISPLACEMENT_Z	ACCELERATION_X
DISPLACEMENT_TOTAL	ACCELERATION_Y
VELOCITY_X	ACCELERATION_Z
VELOCITY_Y	ACCELERATION_TOTAL

7.3.2. CURRENT LAYER

The user can select any layer in the element to show the result. The layer is corresponding to the integration point through the element thickness. Middle layer is the default setting in the program.

7.3.3. INCREMENT

This function is used to display difference value between two neighboring frames as result.

7.3.4. UNDEFORM

This function allows the resultant contour to be displayed on the un-deformed, original mesh. Refer to Figure 7.8 and Figure 7.9 to compare the result displayed on the un-deformed mesh and deformed mesh.

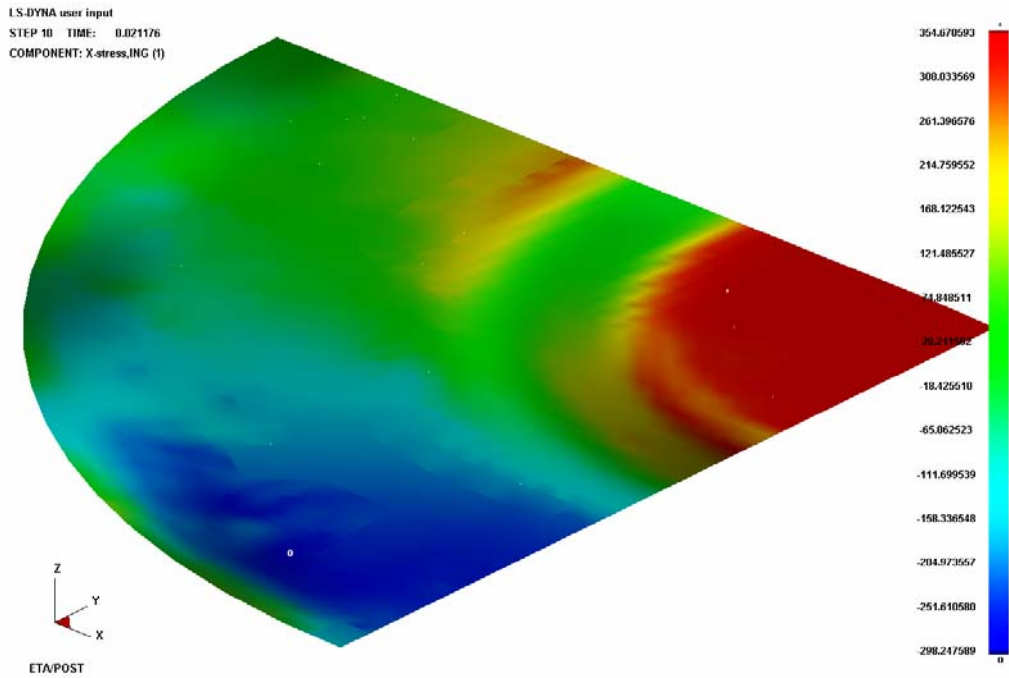

Figure 7.8 Contour display on un-deformed mesh

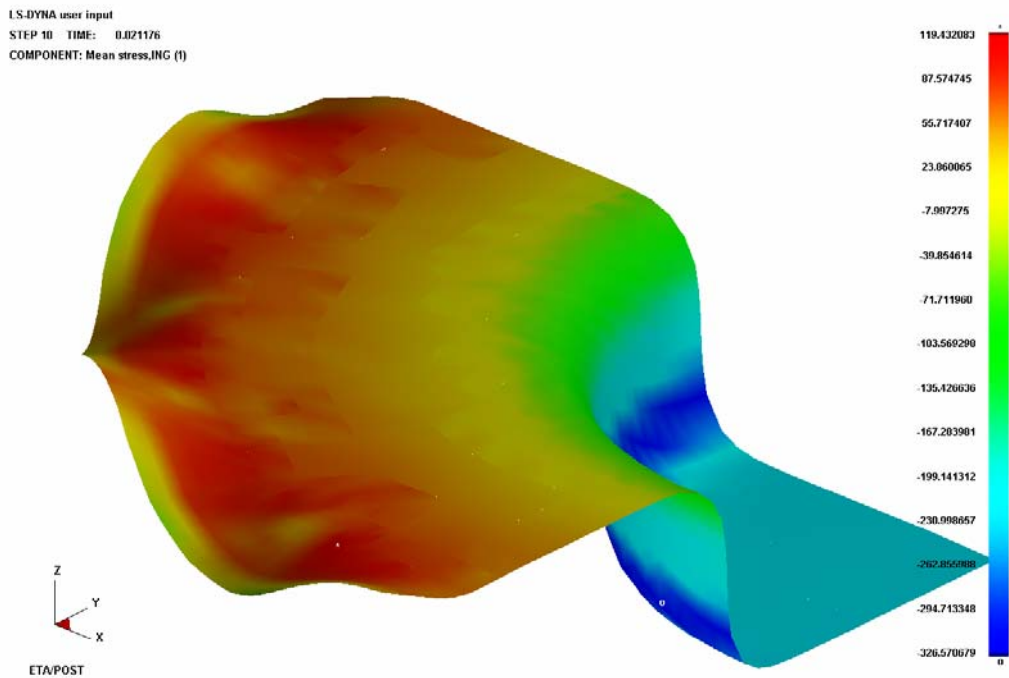

Figure 7.9 Contour display on deformed mesh

7.3.5. ELEMENT RESULT

This option allows the user to show the result by element instead of contour interpolated by nodes.

7.3.6. CONTOUR SETTING

This function will start the Contour Bar Options Control Window shown as Figure 7.10. The user can use these functions to customize the contour setting for animation.

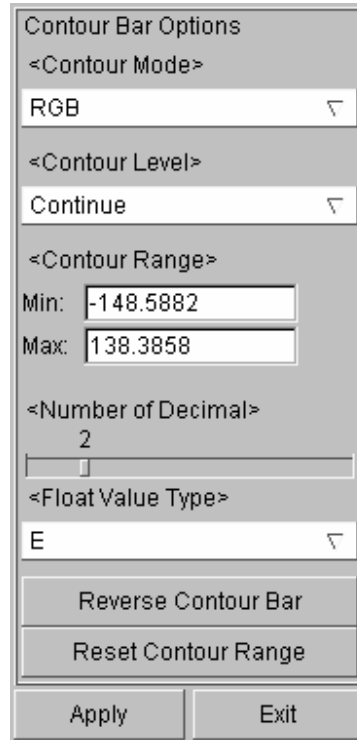

Figure 7.10 Contour Setting box

- REVERSE CONTOUR BAR

This function allows the user to reverse the color of the contour bar for animation. The result of the reverse contour bar is shown in Figure 7.11.

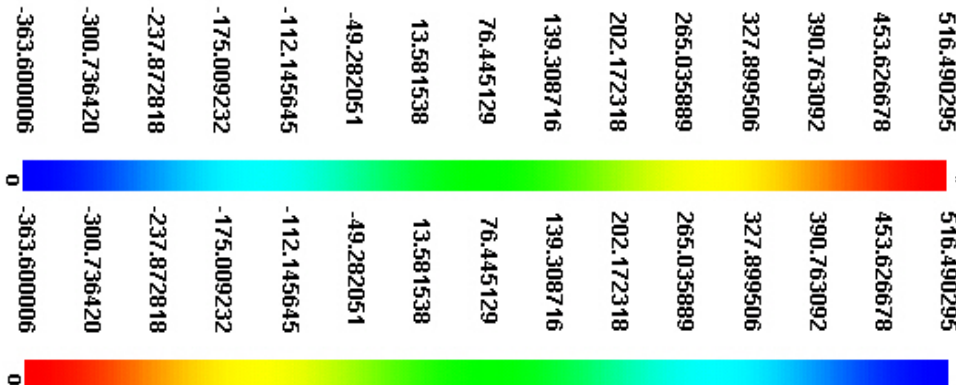

Figure 7.11 The Reverse contour Bar result

- CONTOUR RANGE

The user can define the contour range for the contour bar by entering the values for the minimum and maximum range. If the entered value is lower than the maximum, the contour color of the result above the range is displayed in darker color than the top box in the contour bar. If the entered value is higher than the minimum value, the contour color of the result below range is displayed in dark color of the bottom box in the contour bar. The user may change the color of these two color boxes by clicking the color box in the CONTOUR BAR OPTION window. Figure 7.12 shows a typical contour plot with user defined color range.

Click the APPLY button to update the contour display according to new contour range.

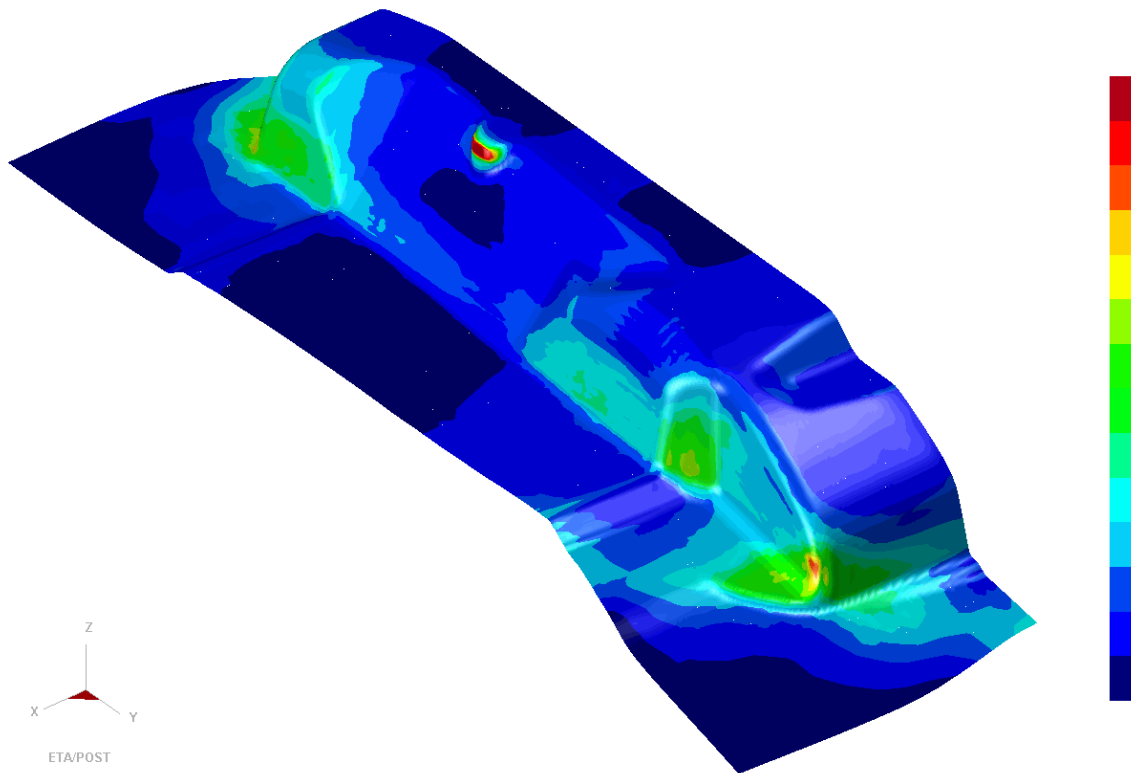

Figure 7.12 A typical contour plot with Contour Range

- RESET CONTOUR RANGE

This function resets the contour value range to the default maximum/minimum values of the entire animation.

- CONTOUR MODE

There are four types of color settings.

RGB (red, green, blue)

- RGBM (red, green, blue, magenta)
- RG (red, green)
- GRAY

● CONTOUR LEVEL

The contour level can be set from 2-20 levels. The program defaults to CONTINUE. If the user sets the contour level with any value 2-20, the contour color is displayed as solid color for each contour value in the contour bar. Figure 7.13 shows a contour plot with 12 colors in RGB mode.

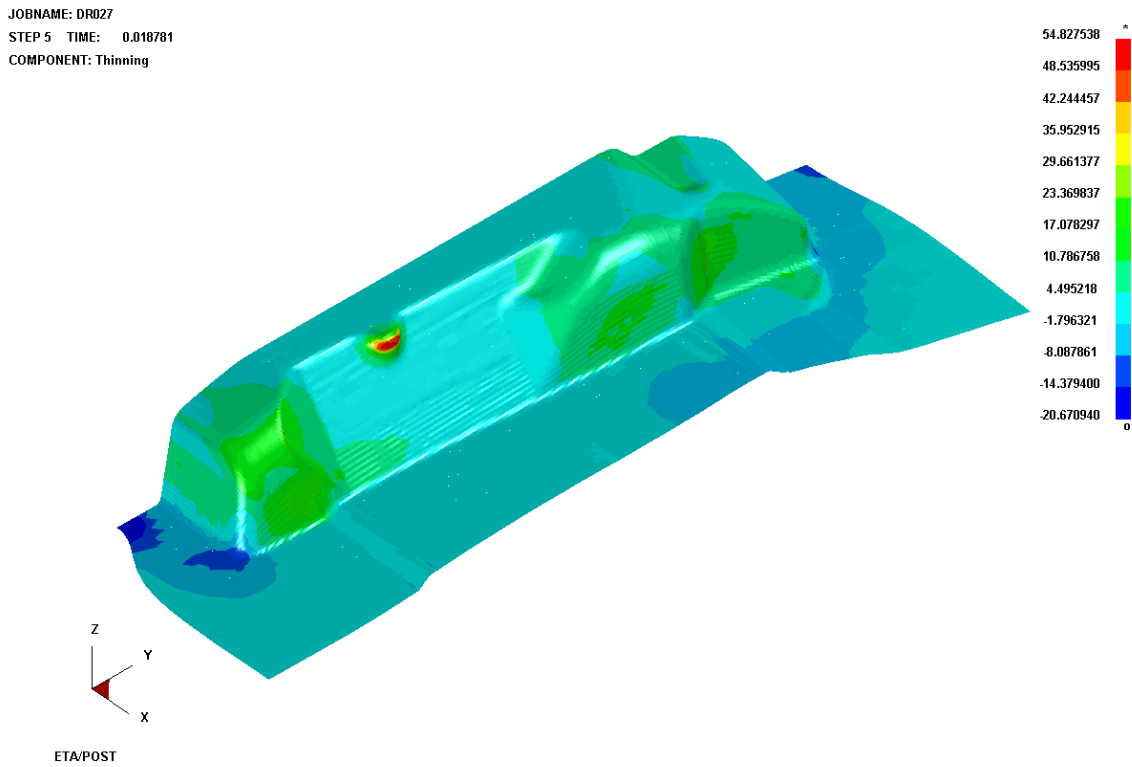

Figure 7.13 An Example for Contour plot of 12 colors

● NUMBER OF DECIMAL

Number of decimal can be set from 1 to 7. default value is 2. Click APPLY button to renew contour according to the new number of decimal.

● FLOAT VALUE TYPE

There are two types of float value: E(default), F. E stands for scientific notation and F stands for decimal notation. Click APPLY button to renew contour according to the new float value type.

7.3.7. EXPORT CONTOUR LINE

This function allows the user to export the contour line (only when the CONTOUR LEVEL is not

CONTINUE) to a DYNAFORM Line Data file.

eta/Post prompts the user to enter the file name. After entering the file name and clicking SAVE button, the contour lines will be saved to the defined file.

7.3.8. LIST VALUE

This function lists the contour value of selected nodes or selected element (if ELEMENT RESULT is selected, then list element contour value). For example, list node value in the following steps:

Click the LIST VALUE function in the CONTOUR CONTROL WINDOW.

The Control Option window is displayed with Select Node Option shown as Figure 7.14.



Figure 7.14 Select Node Control Option

Select the desired option from the list. The default setting is by mouse pick. The user can also select nodes by dragging window, polygon or free hand region.

Once the nodes are selected, the highest 10 values are listed at the lower left corner of the GRAPHICS DISPLAY WINDOW as shown in Figure 7.15.

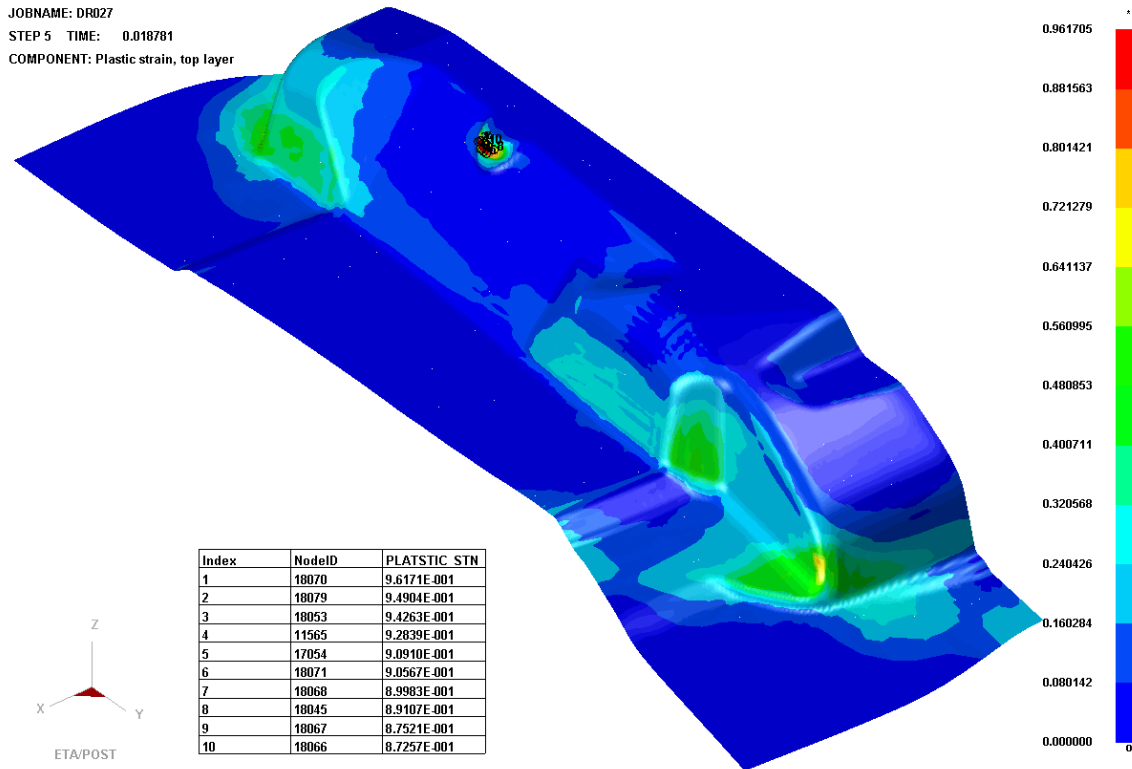

Figure 7.15 List Node Value

A Control Option Window appears shown as Figure 7.16. These functions control the position and number of contour values listed.



Figure 7.16 List Value Control Option

- HIGHEST

The set of nodes with the highest value are listed.

- NEXT HIGHEST

The set of nodes with next highest value are listed.

- NEXT LOWEST

The set of nodes with next lowest value are listed.

- LOWEST

The set of nodes with the lowest value are listed.

- LIST PER PAGE

The function prompts a data control window that allows the user to enter the number of the listed nodes.

- SET LIST POSITION

This function allows the user to place the list window by the cursor pick.

Other functions are common to those in the DEFORM animation.

7.4. VECTOR



The functions in this menu animate the analysis results with vectors in real time. The options are shown in Figure 7.17.

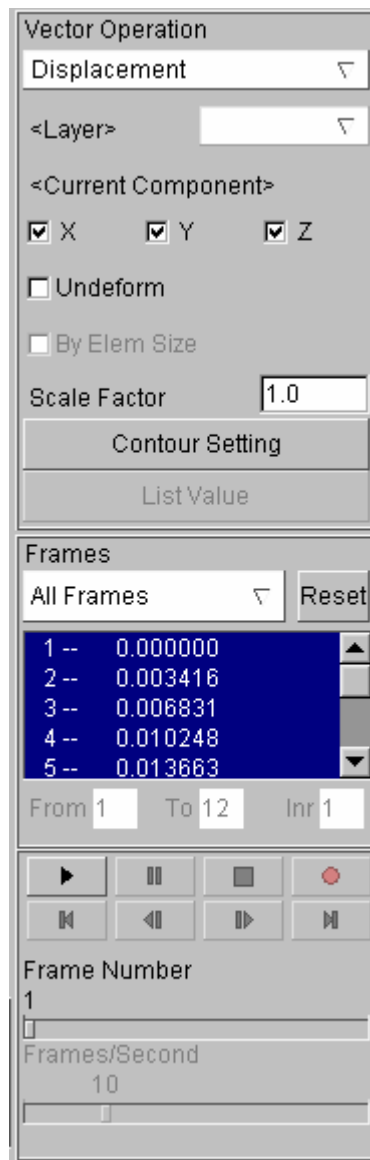

Figure 7.17 Vector Operation control window

7.4.1. SELECT COMPONENT

There are four types of component, DISPLACEMENT, VELOCITY, ACCELERATION, STRESS and STRAIN in the function.

If DISPLACEMENT, VELOCITY or ACCELERATION is selected, the CURRENT LAYER is disabled, and the CURREN COMPONENT is enabled used. The user can select any component or any combination of them from the list.

If STRESS or STRAIN is selected, the CURRENT LAYER is enabled and the CURRENT COMPONENT is disabled. There are MIDDL, TOP and BOTTOM available in the CURRENT LAYER.

7.4.2. BY ELEMENT SIZE AND SCALE FACTOR

This function is used to control the size of the vector.

BY ELEMENT SIZE will scale the vector size to fit within the element. This option is only efficient to STRESS or STRAIN. If select STRESS or STRAIN, then BY ELEM SIZE is activated. If select DISPLAYCEMENT, VELOCITY or ACCELERATION, then BY ELEM SIZE is closed.

SCALE FACTOR allows the user to enter a scale factor to vector length according to the magnitude of the result.

Note: The SCAL FACTOR is disabled when BY ELEMENT SIZE is selected.

SPECIAL ICONS FOR eta/DYNAFORM

Those icons are special for eta/DYNAFORM post-processing. If the user opens a result file of a DYNAFORM simulation, these icons will be displayed in the top of CONTROL WINDOW. This allows the user to quickly select the type of result to be reviewed by a simple mouse click.

7.5. FLD

This function is used to evaluate the formability of the blank (safety and failure zones). The X and Y-axes in the diagram represent the minor and major strains of each element. The options in this menu are shown in Figure 7.18.

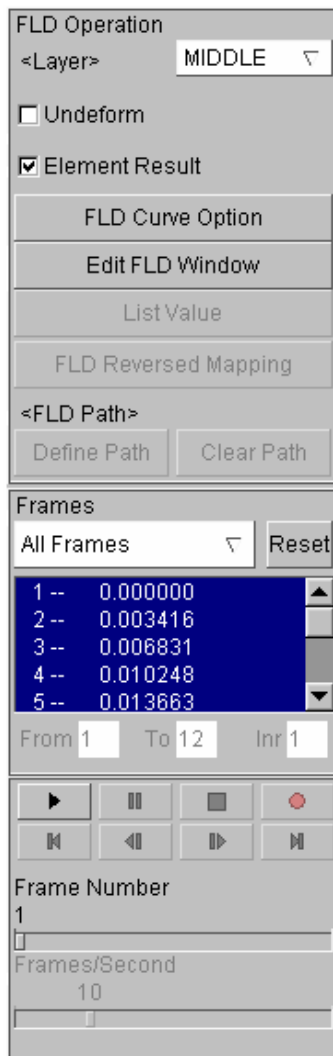

Figure 7.18 FLD control window

7.5.1. FLD CURVE OPTION

This function allows the use to define the FLD curve and other parameters for FLD evaluation. The program displays the FLD CURVE AND OPTION window as shown in Figure 7.19.

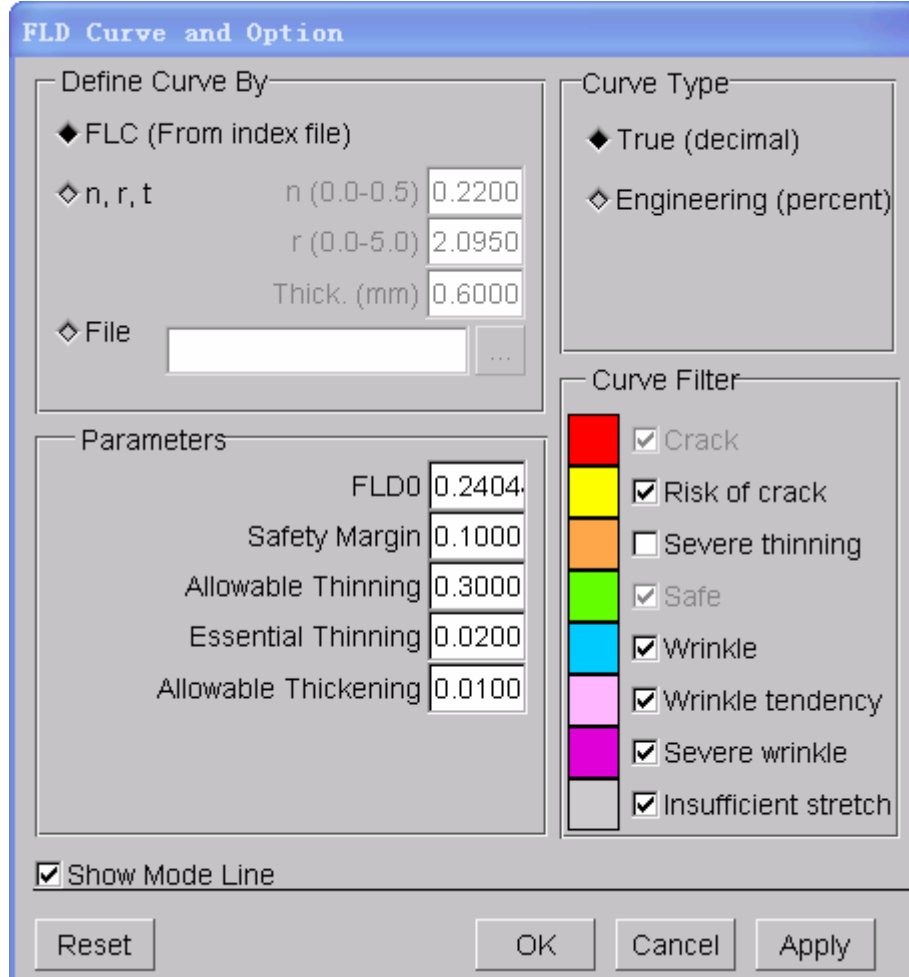

Figure 7.19 FLD Curve and Option

1. DEFINE CURVE BY

- FLC (From index file)

If user defined FLC curve when pre-processing, program automatically includes FLC curve in output idx file. Post processor gets FLC curve from idx file default. FLC curve type in idx file is engineering strain type. If user uses FLC curve with true strain format, when inputting in pre-processor, true strain transfers into engineering strain format, and then input to pre-processor, or adopts File method to import FLC described in follows..

Detailed information about INDEX (idx) file format refers to APPENDIX A.

- n,r,t

If FLC curve not defined in pre-processor, then FLC (From index file) option mentioned above is not activated. Program obtains n, r, t parameters from idx file default and then gets the FLC curve approximately according to Keeler's formula. If user has not assigned idx file, or does not have *.idx file (for example user opens result file calculated by older version DYNAFORM), program adopts a group of default n, r, t parameter to calculate FLC curve. At this time, user should adjust n, r, t manually to get FLD curve matched blank material.

Following is adopted Keeler's formula:

$$FLD_0 = n * (23.3 + 14.134 * t) / 21.0, \quad 0 < t < 2.54mm ;$$

$$FLD_0 = n * (20.0 + (20.669 - 1.938 * t) * t) / 21.0, \quad 2.54 \leq t \leq 5.33mm ;$$

$$FLD_0 = 75.125 * n / 21.0, \quad t \geq 5.33mm .$$

FLC shape is decided by formula below:

$$\varepsilon_{maj} = FLD_0 + \varepsilon_{min} * (0.027254 * \varepsilon_{min} - 1.1965) \quad \varepsilon_{min} < 0 ;$$

$$\varepsilon_{maj} = FLD_0 + \varepsilon_{min} * (-0.008565 * \varepsilon_{min} + 0.784854) \quad \varepsilon_{min} > 0 .$$

- File

Define FLD curve by importing curve file(*.fld). Figure 7.20 shows an example of FLD file. User may refer to the format to create fld file. \$FORM LIMIT DIAGRAM is necessary keyword, other keyword is optional. Safety margin defines the distance from the Marginal curve to the failure curve. Type defines the curve type, 0 for true strain, 1 for engineering, 2 for engineering percent. There is no FLD curve type in the old FLD format, its curve type is decided by FLD parameter in etapost.config which is configuration file of post-processor program. So when using old FLD curve, pay attention, make sure that the added type messages in FLD file or FLD parameter in adjust configuration file match with FLD curve.

```

$FORM LIMIT DIAGRAM,SAFETY MARGIN:0.10 TYPE:0
-0.30 0.8540
-0.20 0.5800
-0.10 0.3910
0.00 0.3040
0.05 0.3316
0.10 0.3656
0.15 0.3910
0.20 0.4100
0.30 0.4328
0.45 0.4530

$FORM LIMIT DIAGRAM --- File Identifier (must exist)
SAFETY MARGIN:      --- Safety margin
TYPE:               --- 0 - True
                   1 - Engineering
                   2 --Engineering Percent

```

Figure 7.20 FLD file format

2. CURVE TYPE

The function allows the user to switch the FLD type between the engineering and the true strain for FLD evaluation.

3. PARAMETERS

- FLD0

FLD0 is the lowest point on the failure curve. The user can move the failure curve in Y-direction by entering a FLD0 value.

- SAFTY MARGIN

The user can define the margin area of the FLD by changing the distance from the margin curve to the failure curve. The setting for SAFETY MARGIN determines what range of strain below the FLD is defined as at risk of cracking. Generally, this is set to 10 percent below the failure curve.

- ALLOWABLE THINNING

The setting for ALLOW THINNING determines what percent thinning of material in biaxial mode. Generally, it is recommended to set it to about 30%.

- ESSENTIAL THINNING

The ESSENTIAL THINNING setting determines what minimum percent thinning of material is required to determine a required stretch.

- ALLOWABLE THICKENING

The ALLOW THICKENING setting determines what percent gathering of material is necessary before the material is defined as wrinkling. This default set at 2%.

4. CURVE FILTER

FLD divides the whole model into 8 areas based on the formability of the part. Each area is shown in a unique color. An example of FLD is as Figure 7.21.

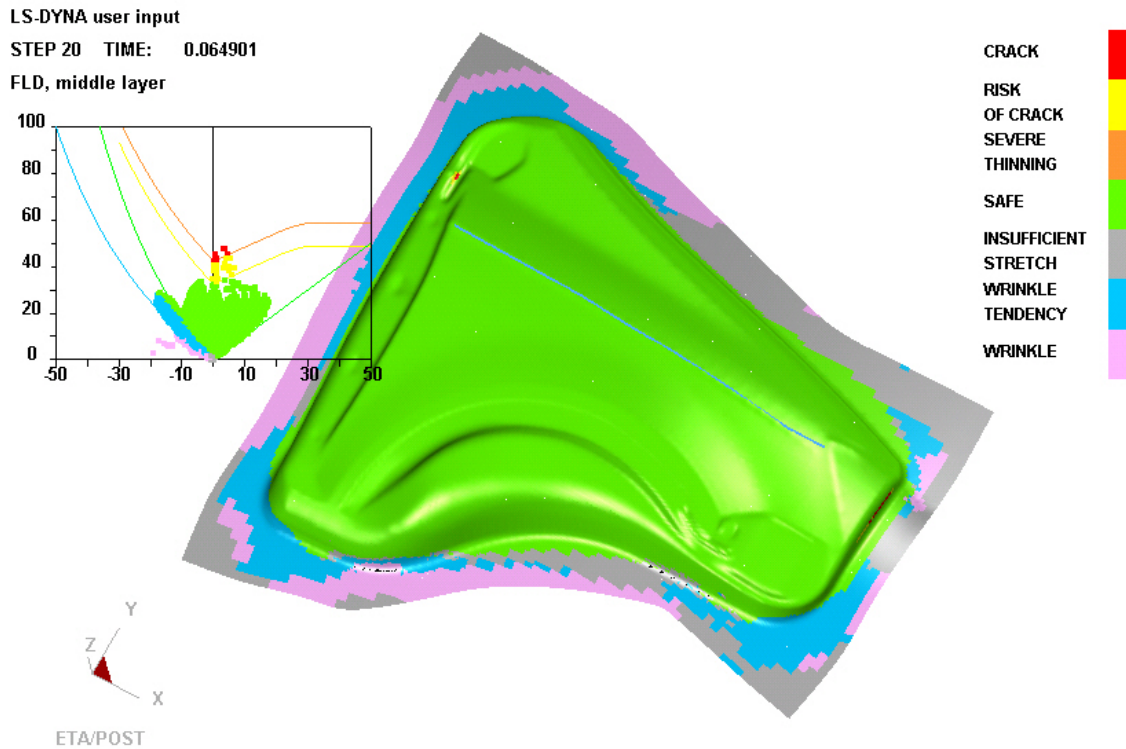

Figure 7.21 An Example of FLD evolution

Any of the area except CRACK and SAFE can be turned off by un-checking the option box under CURVE FILTER in the FLD CURVE and OPTION window.

5. SHOW MODE LINE (toggle)

Toggles ON/OFF the forming mode lines in the FLD window.

7.5.2. EDIT FLD WINDOW

This function allows the user to change the size and location of the FLD window by a drag window. Once the function is selected, the user is prompted to drag a window to define FLD in the GRAPHICS DISPLAY WINDOW. The user may try as many size and location as he wishes until he clicks the EXIT button in the control window.

7.5.3. FLD REVERSED MAPPING

This function allows the user to trace the elements in the model from the FLD window. The user moves the curve to a particular point in the FLD window to highlight the corresponding elements in the model. Click the left mouse button to stop the tracing. The program will label the corresponding elements with the element and node numbers.

7.5.4. FLD PATH

This function is used to track selected element strain path in FLD during the whole deform process. Define Path is used to select required element from the graphic. After defining and exit, program automatically calculate the strain change path of the selected element deform process and individually displays it in FLD graphic. See Figure 7.22. Click Clear Path to clear defined strain path, FLD returns to the default FLD graphic of all parts under current frame

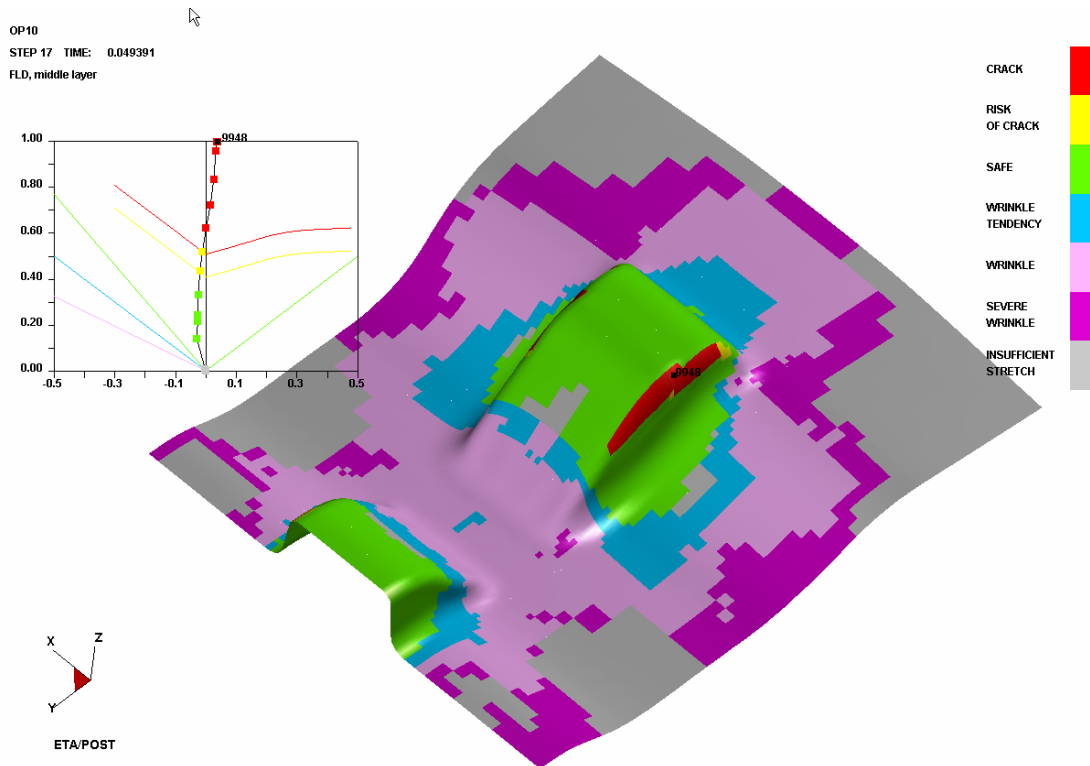

Figure 7.22 FLD Strain Path

7.6. THICKNESS



This function animates the contour of blank thickness to estimate the stamping quality. The program displays a control window as shown in Figure 7.23. Functions of other buttons see Chapter 7.1 and 7.2.

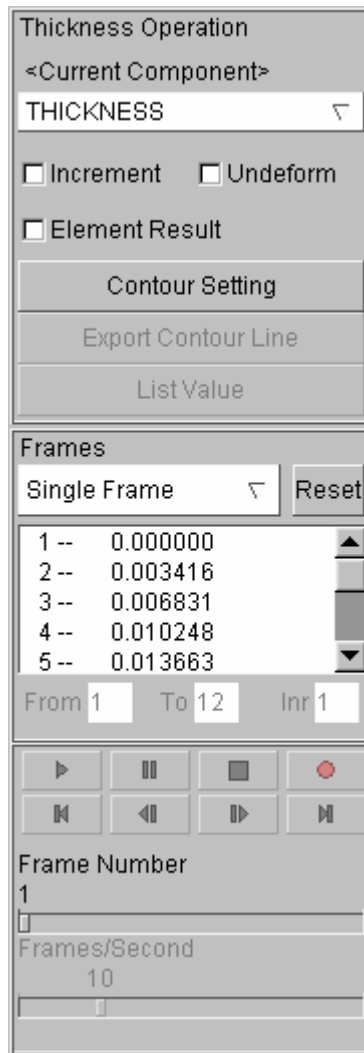

Figure 7.23 Thickness Control Window

The user may select THICKNESS, THICKNESS STRAIN or THINNING from the drop down menu to animate the thickness, thickness strain or thinning of the blank. For thickness contour, the program automatically switches to REVERSE CONTOUR BAR mode to plot the thinnest area in red and the thickest area in blue. See the Figure 7.24 and Figure 7.25 for a sample plot of thickness and thinning contour.

LS-DYNA user input
STEP 20 TIME: 0.064901
COMPONENT: Thickness

Y
X
ETA/POST

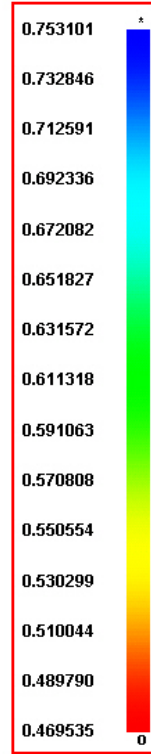
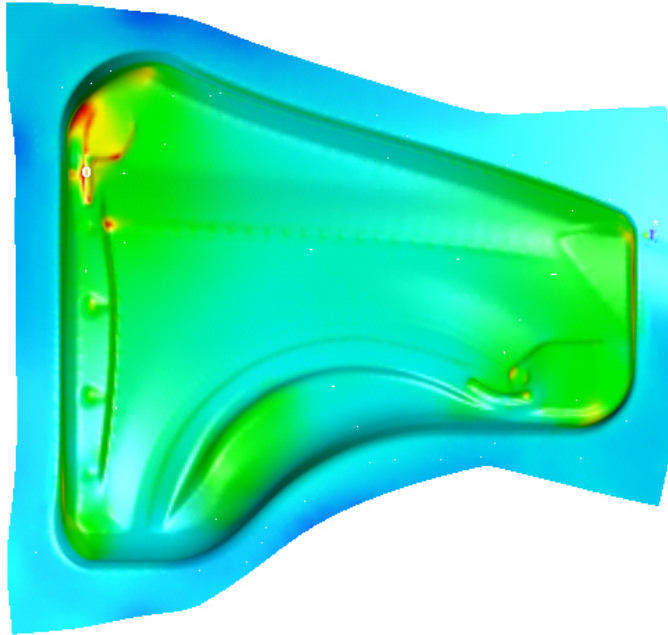

Figure 7.24 Thickness Contour

LS-DYNA user input
STEP 20 TIME: 0.064901
COMPONENT: Thinning

Y
X
ETA/POST

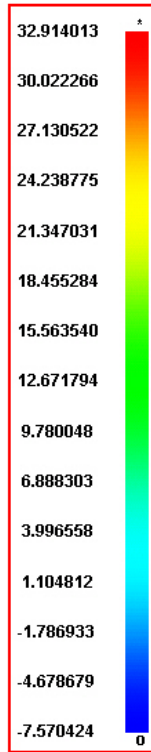
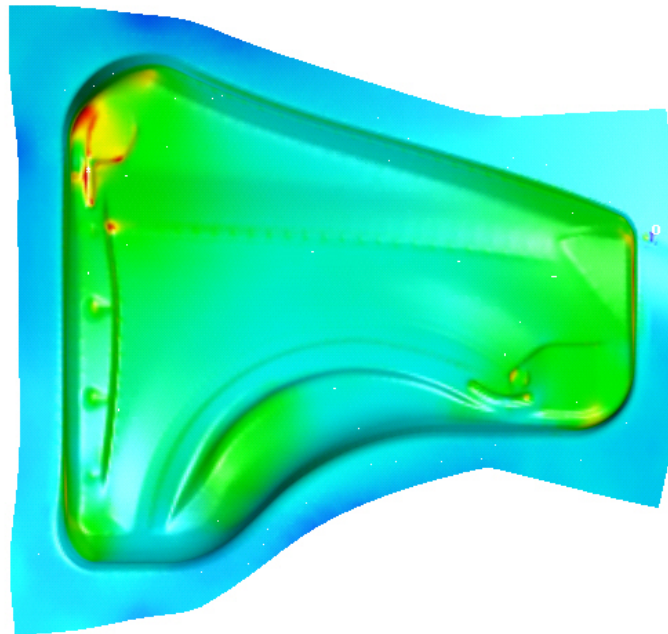

Figure 7.25 Thinning Contour

7.7. MAJOR AND MINOR STRAIN

This function allows the user to display, animate and list the major/minor principal strains. Figure 7.26 show the control window for the Major and Minor Strain function. Functions of other buttons see Chapter 7.1 and 7.2.

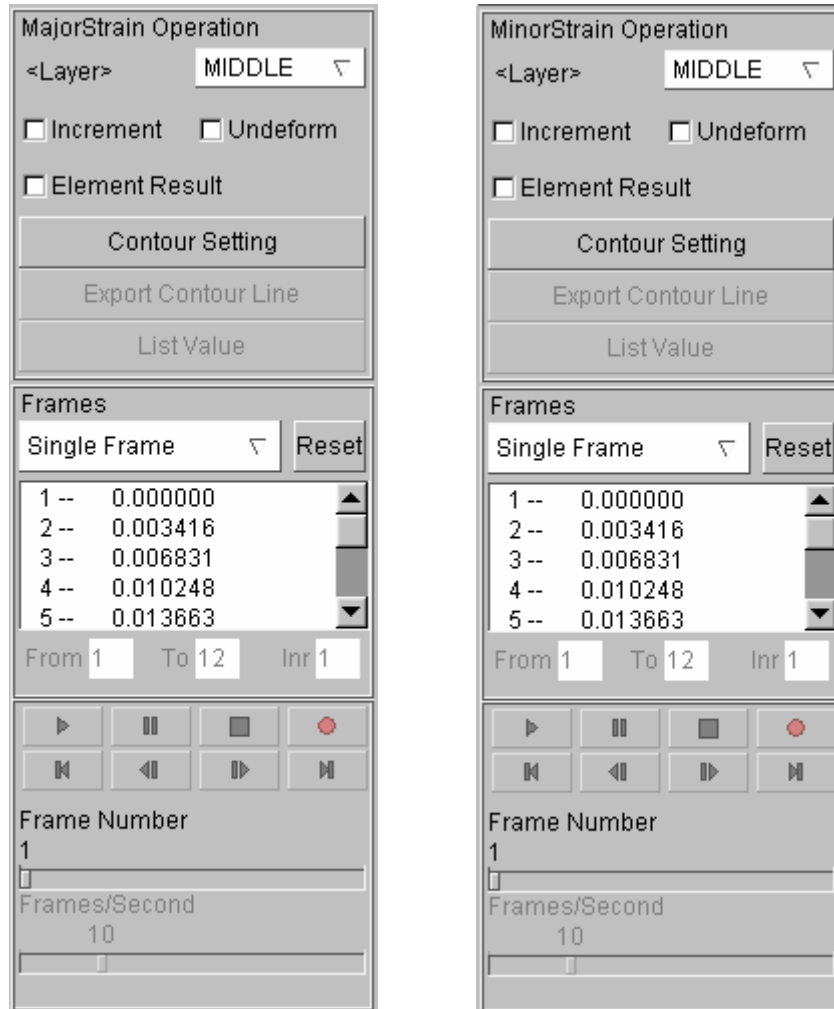

Figure 7.26 Major Strain and Minor Strain

Other functions are common to other functions in the previous sections.

7.8. IN PLANE STRAINS

The functions in this window allow user to animate the principal in-plane strains. The program displays a control a display window as shown in Figure 7.27. Functions of other buttons see Chapter 7.1 and 7.2.

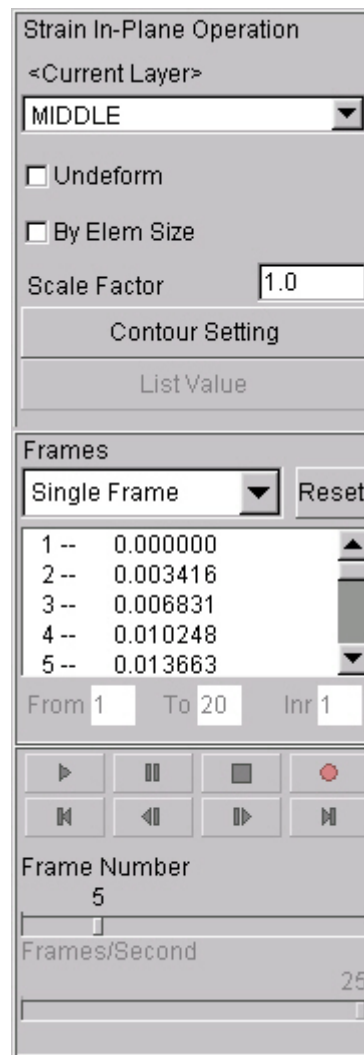

Figure 7.27 Strain In-Plane Control Window

The in plane principal strains are displayed in the model as vectors. The value range is displayed in the CONTOUR BAR.

Other functions are common to the VECTOR function as described in the previous section.

7.9. BLANK TOOL DISTANCE



Blank to Tool distance allows the user to check the distance between a specified tool and the Blank. User can use this function to check the contact pattern during the forming process by animating the distance of the blank and tool. Figure 7.28 shows the control window of the function. Functions of other buttons see Chapter 7.1 and 7.2.

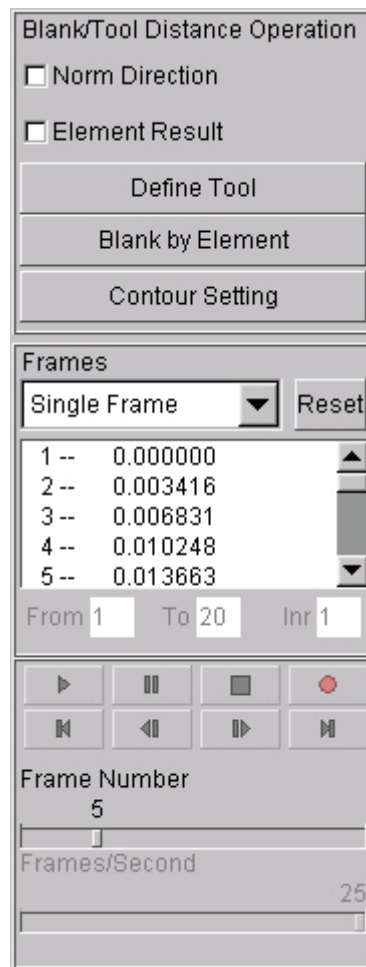

Figure 7.28 Blank Tool Distance

1. NORM DIRECTION (toggle)

If the option is selected, the distance between the blank and the tool is calculated from the normal direction of the selected tool. Otherwise, the distance is calculated from the tool motion direction.

2. DEFINE TOOL

This function allows the user to select the tool for calculating distance. The program displays the Select Part Control Option window as shown in Figure 7.29.



Figure 7.29 Select Part Control Option

User can select part(s) by the cursor pick, dragging window, polygon and free hand region.

3. BLANK BY ELEMENT

This function allows the user to select elements of the blank by cursor pick, dragging window, polygon area or free hand area.

After the tool is defined, the user can animate the blank tool distance contour. Figure 7.30 shows a typical contour plot of the distance between the blank and die at the initial forming step.

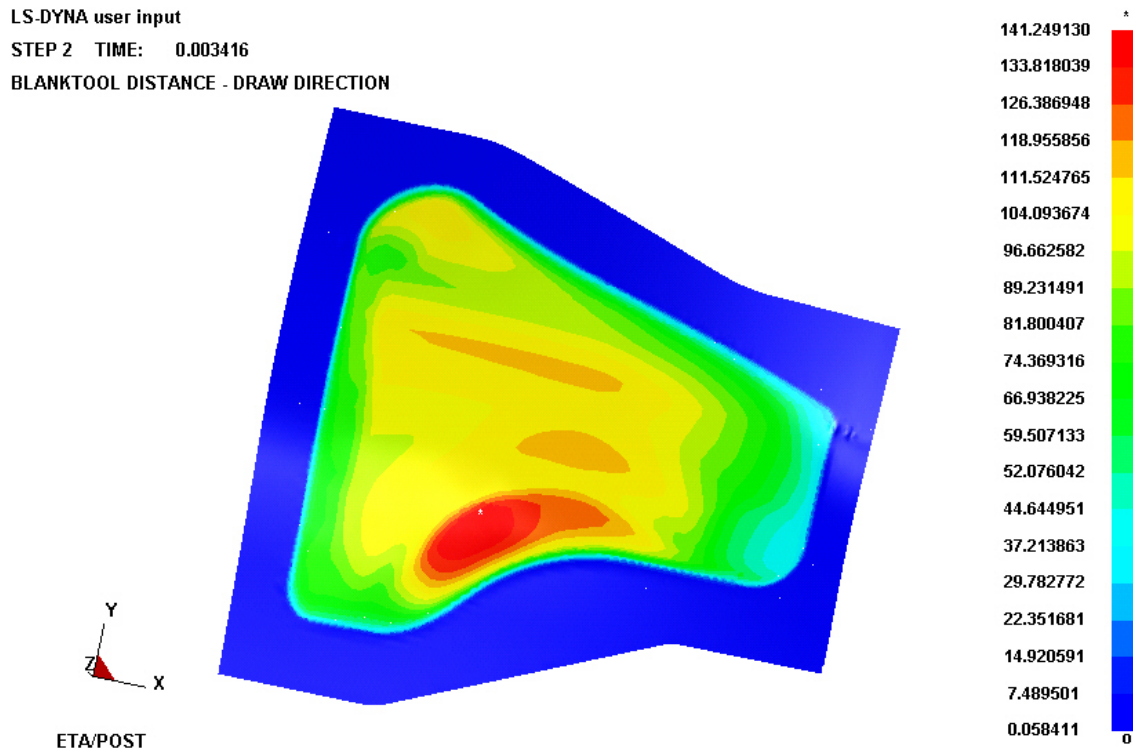

Figure 7.30 Blank and Tool Distance

7.10. CIRCULAR GRID

This function allows user to simulate the circular grid testing in the actual stamping operation. The program paves the circular grid according to the user’s specification on the deformed blank. The deformed circles are calculated based on the element strains and display on the deformed blank. Figure 7.31 shows the control window of the Circular Grid function. Functions of other buttons see Chapter 7.1 and 7.2.

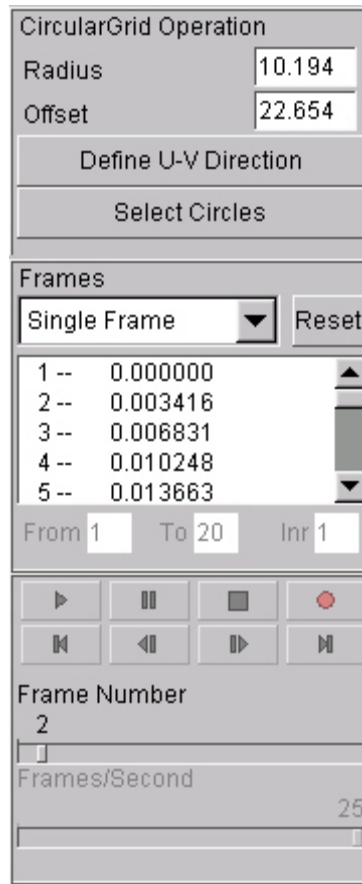

Figure 7.31 Circular Grid

1. RADIUS

This parameter is used to define the radius of the circle. The default value is calculated by the element size.

2. OFFSET

It is the gap distance between two circles in the U and V directions of the circular grid. The default value is calculated by the element size.

3. DEFINE U-V DIRECTION

The U-V plane is used to orient the circular grid direction on the blank. Follow the standard procedure for defining U-V plane.

4. SELECT CIRCLE

This function allows the user to select the circle to list the strain result. It is only activated after the animation is started. The result of the selected circle is displayed in the message window in the following format Please see the Figure 7.32.

[i]-<46> <Major>=-22.8553(%) > <Minor>=38.4680(%)>

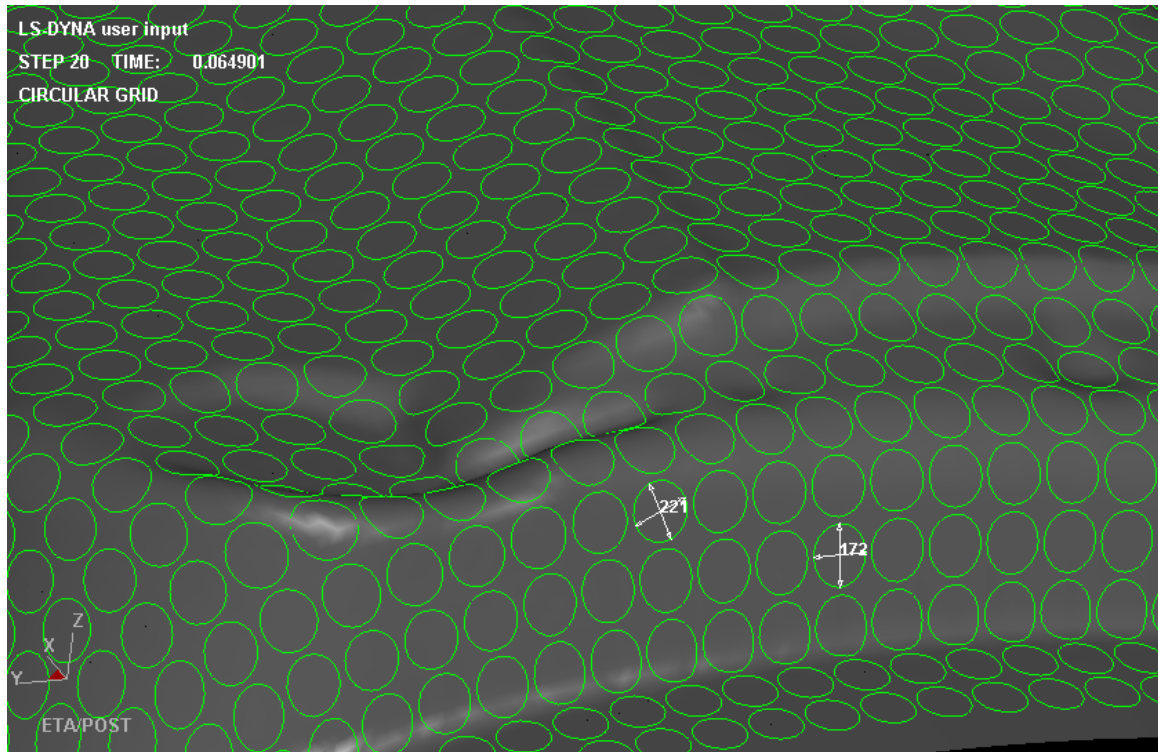

Figure 7.32 A sample plot of Circular Grid

7.11. SKID MARK



Skid Mark function allows user to display any possible impact marks left on the blank by the tools. Figure 7.33 shows the control window of this function. Functions of other buttons see Chapter 7.1 and 7.2.

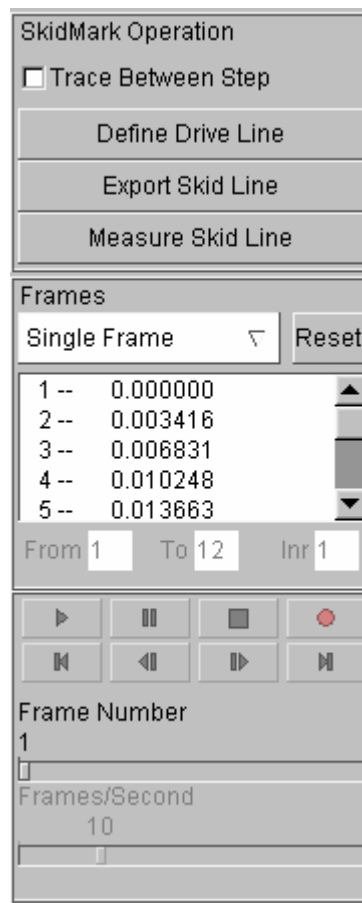

Figure 7.33 Skid Mark Operation

Note: Before starting the function, there should be a line defined in the current database. Otherwise, the program will issue a warning message “No lines in database”.

1. TRACE BETWEEN STEP (toggle)

If the function is selected, one skid line per frame is displayed on the blank. Otherwise, only two skid mark lines are plotted and displayed, one for the original position in the first frame, the other is the position for the current frame.

2. DEFINE DRIVE LINE

This function allows the user to select the drive line(s) by cursor pick, dragging window, polygon or free hand region. The drive line is usually defined on the tool mesh.

3. EXPORT SKID LINE

This function allows the user to export the skid line to a line data file. The program displays a save file dialog window to let the user enter the file name to save the skid line in the eta/DYNAFORM Line Data format.

4. MEASURE SKID LINE

This function is used to measure distance between skid mark and defined driving line.

Figure 7.34 shows a typical plot of Skid Line result. The first position is labeled with red squares and the current position is labeled with yellow squares.

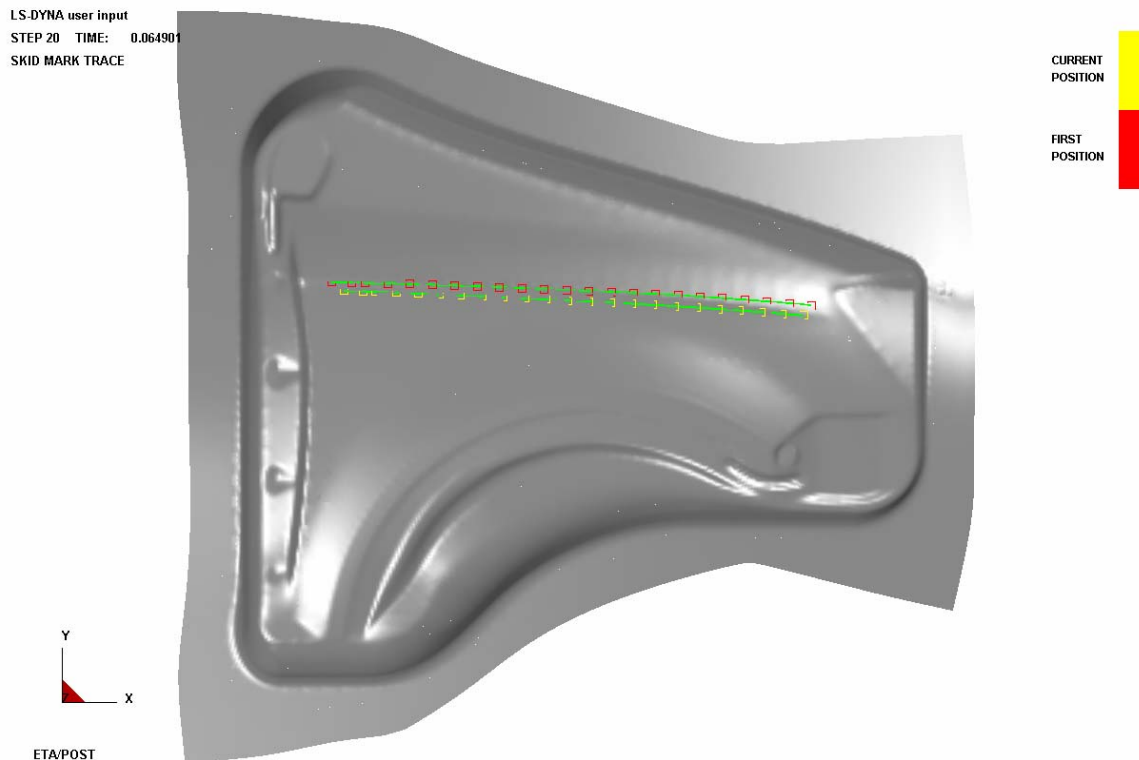

Figure 7.34 A sample plot of Skid Mark

7.12. BLANK OUTLINE

This function calculates the outline of the blank in the binder surface (un-deformed blank). It is used to estimate the necessary blank size to form the part. The calculation is based on the trim line on the part after the draw-die or spring back simulation. The following steps should be followed.

Read in d3plot files from the DYNA analysis.

Read in a line data file for the trim line using the IMPORT function in the FILE menu. The line data file should only consist of the trim line(s). If the line data is not available, use the CREATE LINE function in the EDIT menu to create the trim line.

Select the BLANK OUTLINE function from the icon bar.

The Control Option Window is shown as in Figure 7.35. Click SELECT BY CURSOR to select trim line(s).

After desired trim line is selected, click EXECUTE function to calculate the Blank Outline.

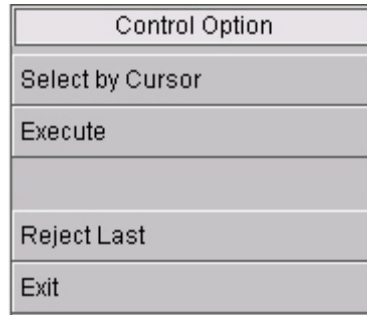

Figure 7.35 Select Line Control Option Window

Note: *If there is no line defined in the database, the program will issue a message “NO LINES IN DATABASE”.*

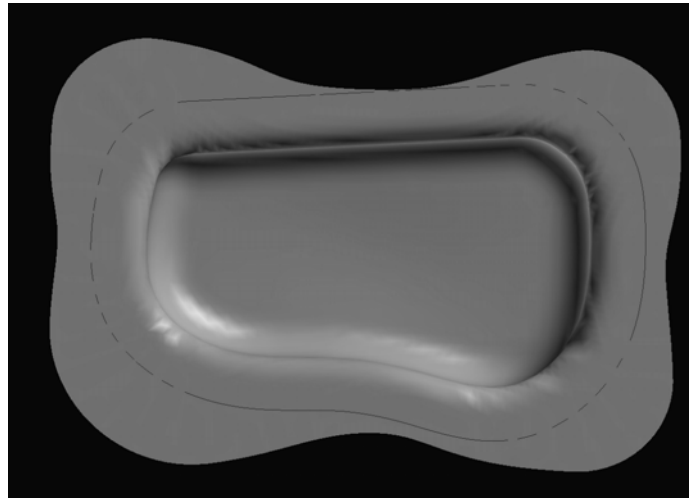

Figure 7.36 Trim Line on Final Step of the Deformed Blank

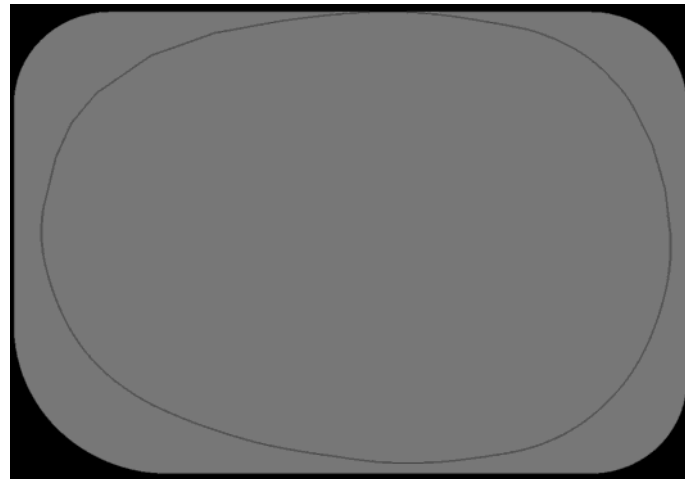

Figure 7.37 Outline on the Undeformed blank

The selected or created trim line will automatically mapped to the original (un-deformed) blank. The user can estimate the blank size from this outline. Functions of other buttons see Chapter 7.1 and 7.2.

7.13. EDGE MOVEMENT

The function enables the user to animate movement of the blanks outer edge in real time. A vector is drawn to show the displacement (including X, Y, and Z orientation) at the boundary nodes of the blank. The contour bar, located on upper right corner of the graphic window, displays the corresponding contour magnitude of the displacement vectors. The location of the highest contour value in the model is labeled with an asterisk (*) and the lowest is labeled with a zero (0). The options for this function are shown in Figure 7.38:

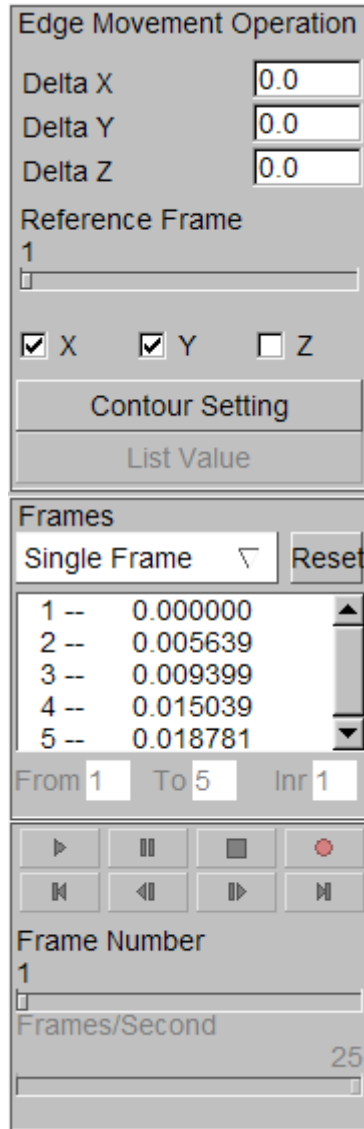

Figure 7.38 Edge movement control window

1. DELTA X/DELTA Y/DELTA Z

Those options enable the user to specify the deviation of the referenced boundary line relative to the original boundary line of the reference frame along the X, Y and Z direction. The defined value will be added to the edge movement vectors.

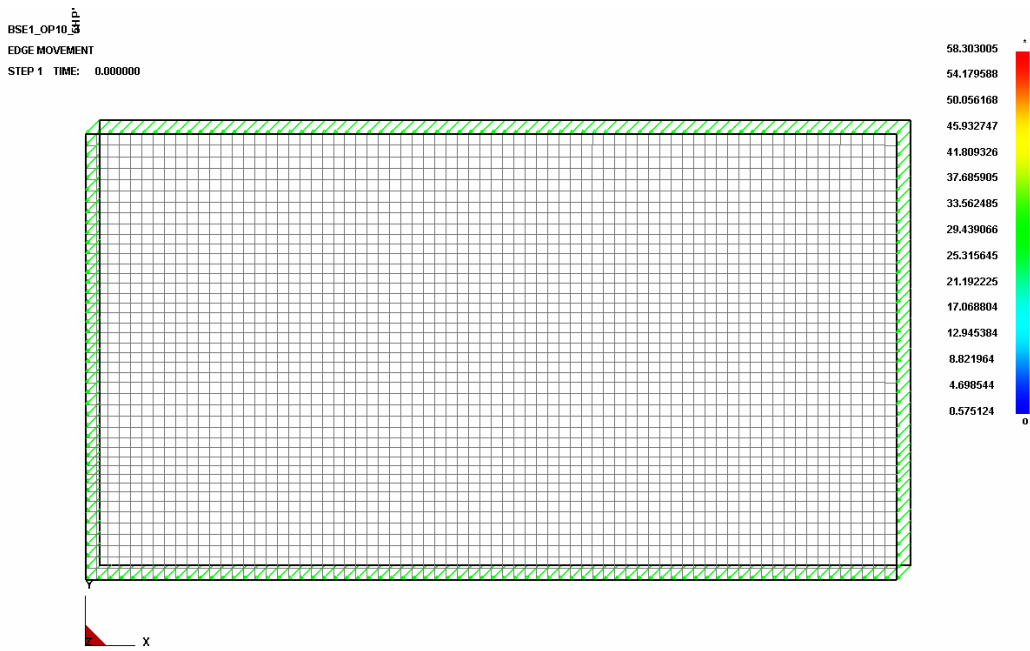

Figure 7.39 Material Float Define

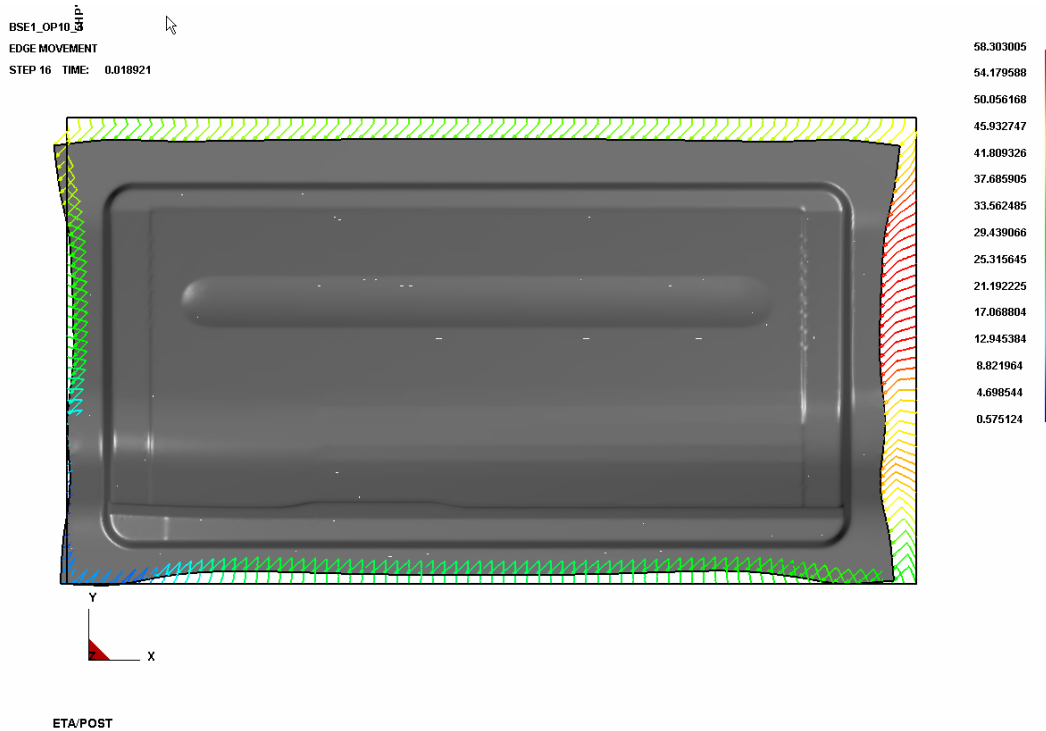

Figure 7.40 X Displacement is 20, the material movement

2. REFERENCE FRAME

This function enables the user to specify which frame to be used as the referenced to calculate the edge movement. The program will use the boundary line of this frame as reference to calculate the

movement vectors. The user can click and slide the slider to select the start frame.

3. COORDINATION OPTION

There are three check box denotes three different orientation X, Y and Z. For example, if toggle on the X, it means that only the displacement on X orientation is calculated and plots on the screen. The user can toggle on all three options one time.

4. SHOW FLOW

This function is used to open or close the initial blank contour and material flow curve between boundaries after deform. Default setting is toggled on.

7.14. DEFECT DETECTION



This function is used to detect the surface defect of the deformed blank. The objective is to simulate the Stone Test in the shop. The control window of this function is shown in Figure 7.41

The screenshot displays the 'Stoning' software interface, which is divided into two main sections: 'Stoning' and 'Frames'.

Stoning Section:

- Unit:** mm (dropdown menu)
- Defect A:** 0.010000
- Defect B:** 0.100000
- Defect C:** 0.200000
- Defect D:** 0.500000
- Stone length:** 10.00000
- Scan Increment:** 0.500000
- Stone Orientation:** X (dropdown menu)
- Stone Side:** + (dropdown menu)
- Element Result
- Compensate Initial Def.
- Select Elms** (button) | **List Value** (button)

Frames Section:

- Frames:** All Frames (dropdown menu) | **Reset** (button)
- Table of frame data:

1 --	0.000000
2 --	0.000399
3 --	0.000799
4 --	0.001200
5 --	0.001599
- From:** 1 | **To:** 17 | **Inr:** 1
- Playback controls: Play, Pause, Stop, Record, Previous, Next, Home, End.
- Frame Number:** 1
- Frames/Second:** 10

Figure 7.41 Defect Detection

DEFECT A, B, C and D are the criteria for the defection. STONE LENGTH is the chord length to calculate the vertical distance to the selected elements. SCAN INCREMENT is the distance between the measurement. STONE ORIENTATION is the selected element coordinate position, click the pulling-down menu on the right of Stone Orientation, option X (default), Y, XY can be selected.

The user should click SELECT ELEMENTS to select elements for processing.

The Select Elements option window is shown in Figure 7.42.

Control Option
Select by Cursor
Select by Window
Select by Polygon
Select by Freehand
Select by Displayed
Reject Last Selected
Redo
Abort Selected
Exit

Figure 7.42 Select Elements Option

After select desired elements, select Exit to exit the function.

The SHOW DEFECT, CLEAR DEFECT and FRAME functions will be activated as shown in Figure 7.43.

Stoning	
Unit:	mm ▾
Defect A:	0.010000
Defect B:	0.100000
Defect C:	0.200000
Defect D:	0.500000
Stone length:	100.000000
Scan Increment:	0.500000
Stone Orientation:	X ▾
Stone Side:	+ ▾
<input type="checkbox"/> Element Result	
<input type="checkbox"/> Compensate Initial Def.	
<input type="button" value="Select Elems"/> <input type="button" value="List Value"/>	
Frames	
Single Frame ▾	<input type="button" value="Reset"/>
1 -- 0.000000	▲
2 -- 0.005680	
3 -- 0.011362	
4 -- 0.017043	
5 -- 0.022723	▼
From 1	To 6 Inr 1
<input type="button" value="▶"/> <input type="button" value="⏸"/> <input type="button" value="■"/> <input type="button" value="●"/>	
<input type="button" value="⏮"/> <input type="button" value="◀"/> <input type="button" value="▶"/> <input type="button" value="⏭"/>	
Frame Number	
3	
<input type="text" value=""/>	
Frames/Second	
10	
<input type="text" value=""/>	

Figure 7.43 Defect Detection

Click any single frame to show defect contour. See Figure 7.44. The contour color is based on the surface defect over the stone length. The red color shows the area on the mesh with the highest defect level.

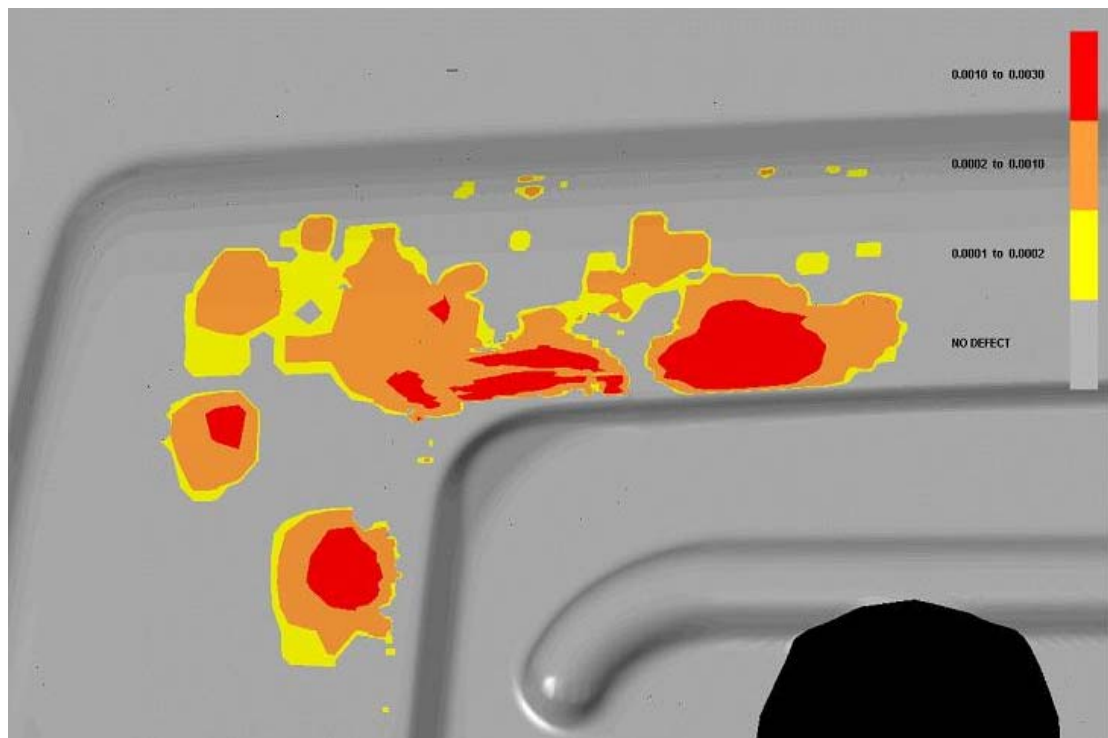

Figure 7.44 An Example of Detect Defection

7.15. BLANK MOVEMENT



This function is used for real-time animation of movement contour of blank compared to its initial statuses. It is mainly used to check spring back value. See Figure 7.45

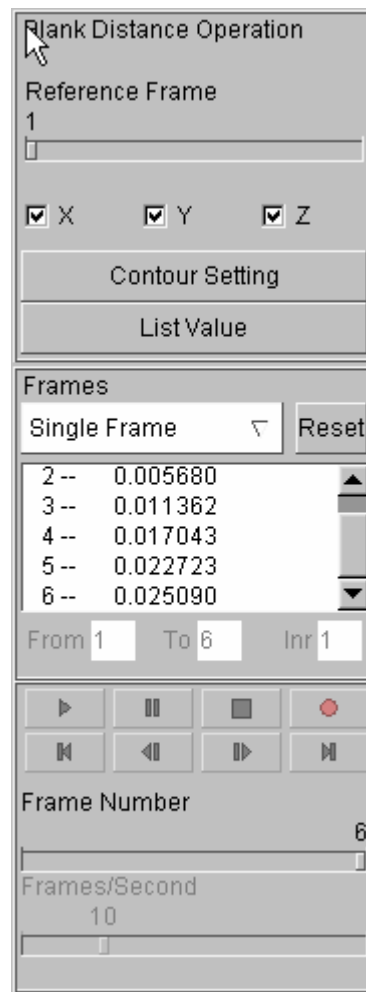

Figure 7.45 Blank Distance

1. REFERENCE FRAME

This function is used to specify reference frame. Program calculates blank distance between the reference frame and any specified frame.

2. COORDINATION OPTION

There are three check box denotes three different orientation X, Y and Z. For example, if toggle on the X, it means that only the displacement on X orientation is calculated and plots on the screen. The user can toggle on all three options one time. See Figure 7.46.

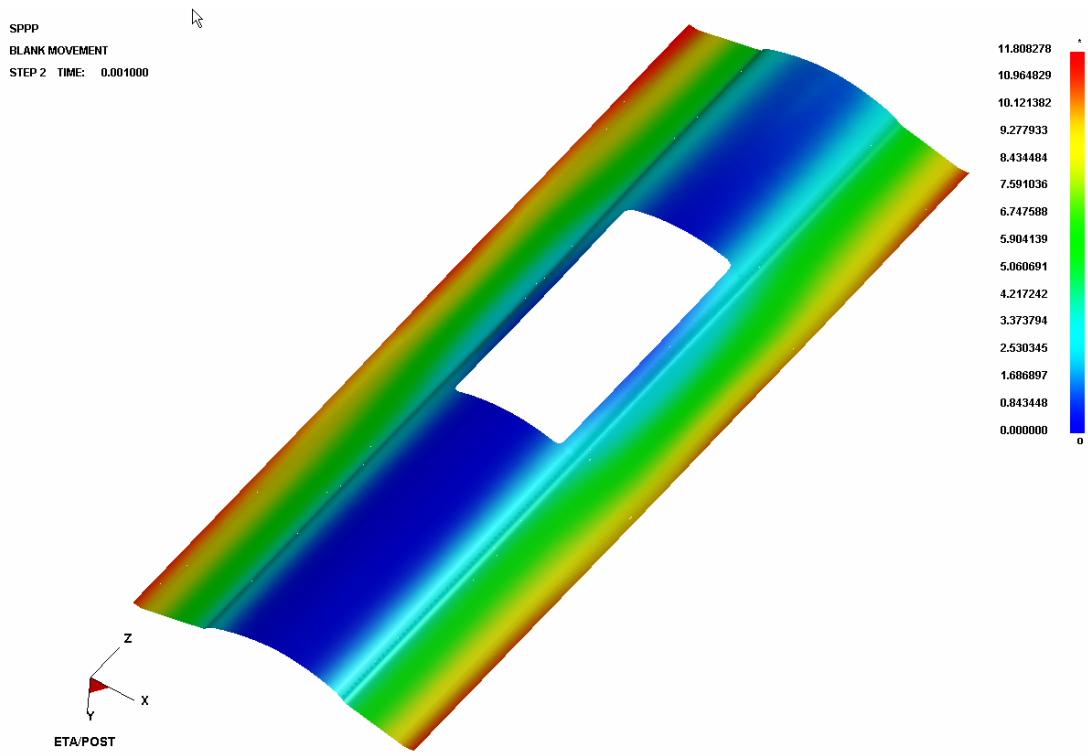

Figure 7.46 Blank Movement Nephogram

8

GRAPH

The GRAPH function is an independent module than other functions in eta/Post. This function enables the user to visualize time history result from LS-DYNA analysis in graph form. In addition, the GRAPH function offers a wide range of tools to help the user better understand and convey the results. Features include the ability to manipulate the display settings (labels, colors, etc) and a host of advanced filtering techniques (FIR, SAE, Butterworth, averaging, etc.) and calculation of different results. The detailed descry-; option of available functions in GRAPH is given in the following sections.

8.1. START UP



The user can activate the GRAPH function by clicking the GRAPH icon on the toolbar. The program will display the graph control window for the user to load the time history result file. The graph control window is shown in Figure 8.1.

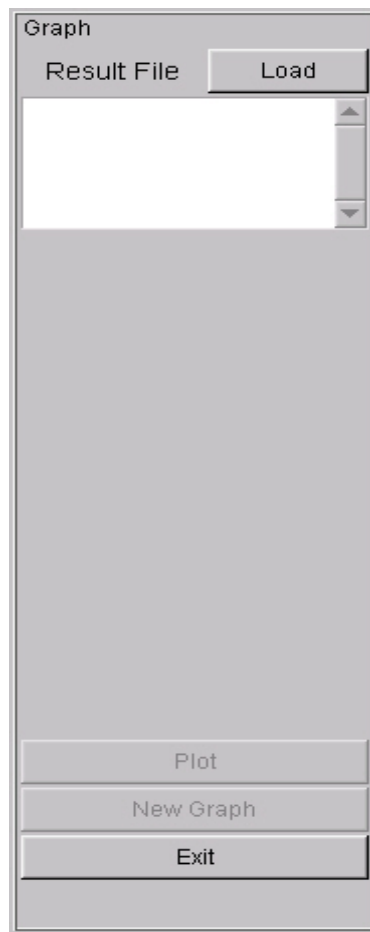

Figure 8.1 Graph start up window

8.2. RESULT FILE LOAD

The function allows the user to read result files from LS-DYNA analysis into the current database. The user can input LS-DYNA ASCII, State and Time data files. Click the LOAD button and the program pops up the Select File dialog box for user to select a database file. The figure is shown in Figure 8.2.

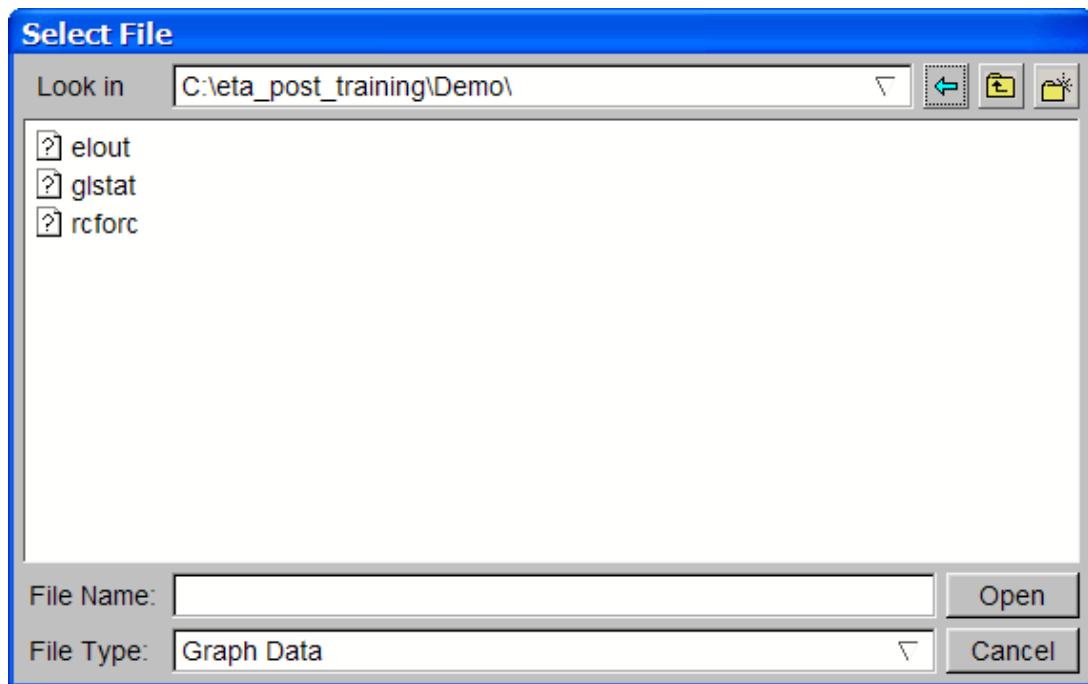

Figure 8.2 Select File dialog box.

Eta-Post supports the following result files from DYNA analysis:

ABSTAT	Airbag statistics
BNDOUT	Boundary nodal forces
DEFGEO	Deformed geometry
DEFORC	Discrete elements
ELOUT	Element data
GCEOUT	Contact element resultants
GLSTAT	Global data
JNTFORC	Joint force file
MATSUM	Material energies
NCFORC	Contact interface forces
NODFOR	Nodal force
NODOUT	Nodal point data
RBDOUT	Rigid body data
RCFORC	Resultant interface forces
RWFORC	Wall forces
SBTOUT	Seatbelt output
SECFORC	Cross section forces

SLEOUT	Sliding interface energy
SPCFORC	Single point constraint (SPC) reaction forces
SSSTAT	Subsystem statistics
SWFORC	Spotweld rivet forces
TPRINT	Temperature output

8.2.1. AIRBAG STATISTICS (ABSTAT)

The user can plot airbag statistic data from the “abstat” file. The following types are available:

VOLUME
PRESSURE
INTERNAL ENERGY
DM/DT IN
GENSITY
DM/DT OUT
TOTAL MASS
GAS TEMPERATURE

8.2.2. BOUNDARY NODAL FORCES (BNDOUT)

The user can plot boundary nodal force time history data from the “bndout” file. The following types are available:

XFORCE
YFORCE
ZFORCE
ENERGY

8.2.3. DEFORMED GEOMETRY (DEFGEO)

The user can plot the deformed geometry data from the “defgeo” file.

8.2.4. DISCRETE ELEMENTS (DEFORC)

This user can plot the discrete element time history data from the “deforc” file. The following types are available:

X-FORCE (MOMENT)
X-FORCE (MOMENT)
X-FORCE (MOMENT)

RESULTANT FORCE (MOMENT)

8.2.5. ELEMENT DATA (ELOUT)

The user can plot element force data from the “elout” file.

8.2.6. CONTACT ELEMENT RESULTANTS (GCEOUT)

The user can plot contact element resultant data from the “gceout” file. The following types are available:

XFORCE
YFORCE
ZFORCE
FORCE MAGITUDE
X MOMENT
Y MOMENT
Z MOMENT
MOMENT MAGNITUDE

8.2.7. GLOBAL DATA (GLSTAT)

The user can plot the global time history data from the “glstat” file. The following types are available:

TIME STEP
TOTAL ENERGY
TOTAL/INITIAL ENERGY
ENERGY RATIO
KINETIC ENERGY/ERODED KINETIC ENERGY
INTERNAL ENERGY/ERODED INTERNAL ENERGY
SPRING & DAMPER EMERGY
HOURGLASS ENERGY
SYSTEM DAMPING ENERGY
SLIDING INTERFACE ENERGY
EXTERNAL WORK
TIME PER ZONE CYCLE
NUMBER OF SHELL ELEMENT
STEP SIZE

GLOBAL X VELOCITY

GLOBAL Y VELOCITY

GLOBAL Z VELOCITY

8.2.8. JOINT FORCE FILE (JNTFORC)

The user can plot the joint force data from the “jntforc” file. The following types are available:

X_FORCE

Y_FORCE

Z_FORCE

X_MOMENT

Y_MOMENT

Z_MOMENT

RESULTANT_FORCE

RESULTANT_MOMENT

8.2.9. MATERIAL ENERGIES (MATSUM)

The user can plot the material energy time history data from the “matsum” file. The following types are available:

INTERNAL ENERGY

KINETIC ENERGY

X MOMENT

Y MOMENT

Z MOMENT

X RIGID BODY VELOCITY

Y RIGID BODY VELOCITY

Z RIGID BODY VELOCITY

8.2.10. CONTACT INTERFACE FORCES (NCFORC)

The user can plot the contact interface force data from the “ncforc” file. The following types are available:

X FORCE

Y FOECE

Z FORCE

PRESSURE

X COORDINATE

Y COORDINATE

Z COORDINATE

8.2.11. NODAL FORCE (NODFOR)

The user can plot the nodal force data from the “nodfor” file.

8.2.12. NODAL POINT DATA (NODOUT)

The user can plot the nodal point data from the “nodout” file. The following types are available:

X DISPLACEMENT

Y DISPLACEMENT

Z DISPLACEMENT

X VELOCITY

Y VELOCITY

Z VELOCITY

X ACCELERATION

Y ACCELERATION

Z ACCELERATION

8.2.13. RIGID BODY DATA (RBDOUT)

The user can plot the rigid body time history data from the “rbdout” file. The following types are available:

X-coordinate

Y-coordinate

Z-coordinate

X-displacement

Y-displacement

Z-displacement

X-ROT-DISPLACEMENT

Y-ROT-DISPLACEMENT

Z-ROT-DISPLACEMENT

X-velocity

Y-velocity

Z-velocity
X-ROT-VELOCITY
Y-ROT-VELOCITY
Z-ROT-VELOCITY
X-acceleration
Y-acceleration
Z-acceleration
X-ROT-ACCELERATION
Y-ROT-ACCELERATION
Z-ROT-ACCELERATION

8.2.14. RESULT INTERFACE FORCES (RCFORC)

The user can plot the resultant interface data from the “rcforc” file. The following types are available:

X FORCE
Y FORCE
Z FORCE
MASS

8.2.15. WALL FORCES (RWFORC)

The user can plot the rigid wall time history data from the “rwforc” file. The following types are available:

NORMAL FORCE
X FORCE
Y FORCE
Z FORCE

8.2.16. SEATBELT OUTPUT (SBTOUT)

The user can plot the seatbelt output data from the “sbtout” file. The following types are available:

SEATBELT
SLIPRING
RETRACTOR

8.2.17. CROSS SECTION FORCE (SECFORC)

The user can plot the cross section time history data from the “secforc” file. The following types are

available:

X FORCE	X MOMENT
Y FORCE	Y MOMENT
Z FORCE	Z MOMENT
X CENTROID	TOTAL FORCE
Y CENTROID	TOTAL MOMENT
Z CENTROID	AREA

8.2.18. SLIDING INTERFACE ENERGY (SLEOUT)

The user can plot the interface energy data from the “sleout” file. The following types are available:

TOTAL SLAVE SIDE
TOTAL MASTER SILE
TOTAL ENERGY

8.2.19. SPC REACTION FORCES (SPCFORC)

The user can plot the SPC reaction force data from the “spcforc” file. The following types are available:

X FORCE
Y FORCE
Z FORCE
X MOMENT
Y MOMENT
Z MOMENT

8.2.20. SUBSYSTEM STATISTICS (SSSTAT)

The user can plot the subsystem statistic data from the “ssstat” file. The following types are available:

KINETIC ENERGY GLOGAL	INTERNAL ENERGY RATIOS 2
KINETIC ENERGY SUBSYSEM 1	INTERNAL ENERGY RATIOS 3
KINETIC ENERGY SUBSYSEM 2	INTERNAL ENERGY RATIOS 4
KINETIC ENERGY SUBSYSEM 3	X MOMENT 1
KINETIC ENERGY SUBSYSEM 4	X MOMENT 2
INTERNAL ENERGY GLOBAL	X MOMENT 3
INTERNAL ENERGY SUBSYSTEM 1	X MOMENT 4
INTERNAL ENERGY SUBSYSTEM 2	Y MOMENT 1

INTERNAL ENERGY SUBSYSTEM 3	Y MOMENT 2
INTERNAL ENERGY SUBSYSTEM 4	Y MOMENT 3
KINETIC ENERGY RATIOS 1	Y MOMENT 4
KINETIC ENERGY RATIOS 2	Z MOMENT 1
KINETIC ENERGY RATIOS 3	Z MOMENT 2
KINETIC ENERGY RATIOS 4	Z MOMENT 3
INTERNAL ENERGY RATIOS 1	Z MOMENT 4

8.2.21. SPOTWELD RIVET FORCES (SWFORC)

The user can plot the weld spot rivet force data from the “swforc” file. The following types are available:

AXIAL

SHEAR

8.2.22. TEMPERATURE OUTPUT (TPRINT)

The user can plot the temperature output data from the “tprint” file. The following types are available:

HEAT GENERATION

TOTAL HEAT GENERATION

CHANGE INTERNAL ENERGY

INTERNAL ENERGY

8.3. Graph Control Window

The user can select a file from the Select File dialog box and click Open to load the file to the program. There are many different types of result files from LS-DYNA analysis that can be read in. The number of result files depends on the type of analysis and the output control setting in pre-processor. The user may load as many files in the current database to process. The program displays the Graph control window as shown in Figure 8.3.

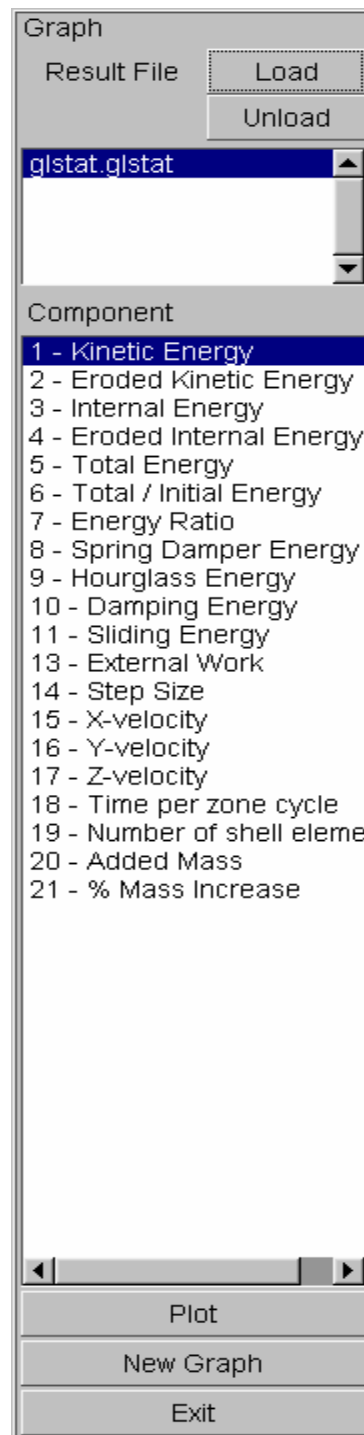

Figure 8.3 Graph control window

There are three List boxes and three function buttons in the Graph window. The number of list boxes depends on the result file type. The detailed description of the functions is given in the follow sections.

1. RESULT FILE

The Result File list box displays the name of result files loaded in the current session. The user

can select the desired file name in the list box to retrieve the related data.

2. TYPE

The items list the Type list box depends upon selected the result file. Only the actual data types in the selected file will be displayed. For example in Figure 8.3, there are two items in the list box (N/A and Wall-1). N/A indicates the first data type is not available.

3. COMPONENT

The COMPONENT list box lists the components according to the selected file and the selected type. The user may select as many components as necessary to be plotted in a graph window. The user may select a component by clicking the name in the list or select multiple components by pressing the SHIFT (range) or CTRL (add) key while clicking the mouse button.

The program plots a curve with a unique colour for each selected component.

4. PLOT

This function plots the selected item(s) in the COMPONENT list box to a curve(s) in current graph window. Figure 8.4 shows a typical graph window in the display window. The user may move the graph window to a different location by dragging the title bar in the graph window.

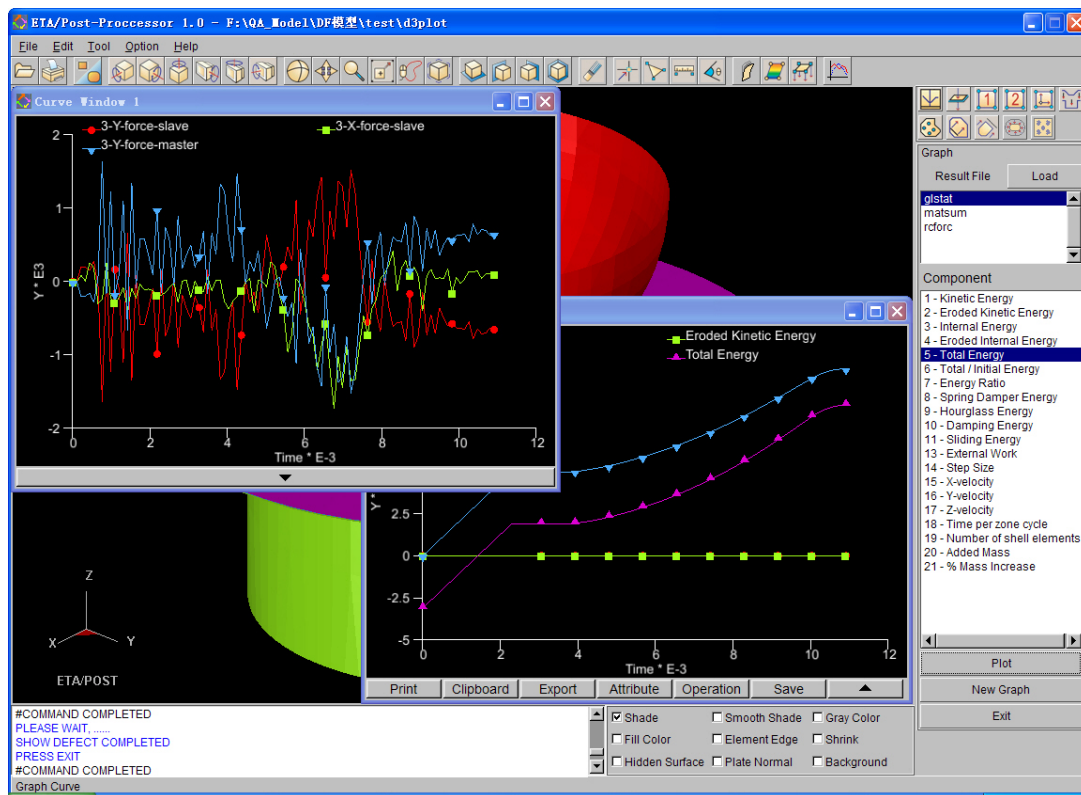

Figure 8.4 Graph window in eta-Post window.

5. NEW GRAPH

This function allows the user to create the new graph window to plot the new curve(s). By default, the new curve is plotted in the current graph window when the user clicks APPLY to plot. This is the same function as in the CURVE OPERATION window.

6. EXIT

This button allows the user to exit the Graph module.

8.4. Graph Operation

GRAPH OPERATION TOOLBAR



The  button at the bottom of the graph window is used to open graph operation toolbar as shown in Figure 8.5.



Figure 8.5 Curve operation toolbar.

There are six functions in the toolbar that can be used to operate the graph window.  This function allows the user to close the graph operation toolbar. Detailed description for each function is given in the following sections.

8.4.1. PRINT

This function enables the user to print or save the content of the current graph window to a picture file. Refer to the section 3.5, PRINT, for more information.

8.4.2. CLIPBOARD

This function enables the user to copy the content of the current graph window to the clipboard. Copy to Clipboard is the standard Windows operation for transferring data between software. The user can copy a graph image directly to other Microsoft programs as a bitmap image provided that the other program supports bitmap image. The image in Figure 8.6 is inserted to Microsoft Word document using the CLIPBOARD function.

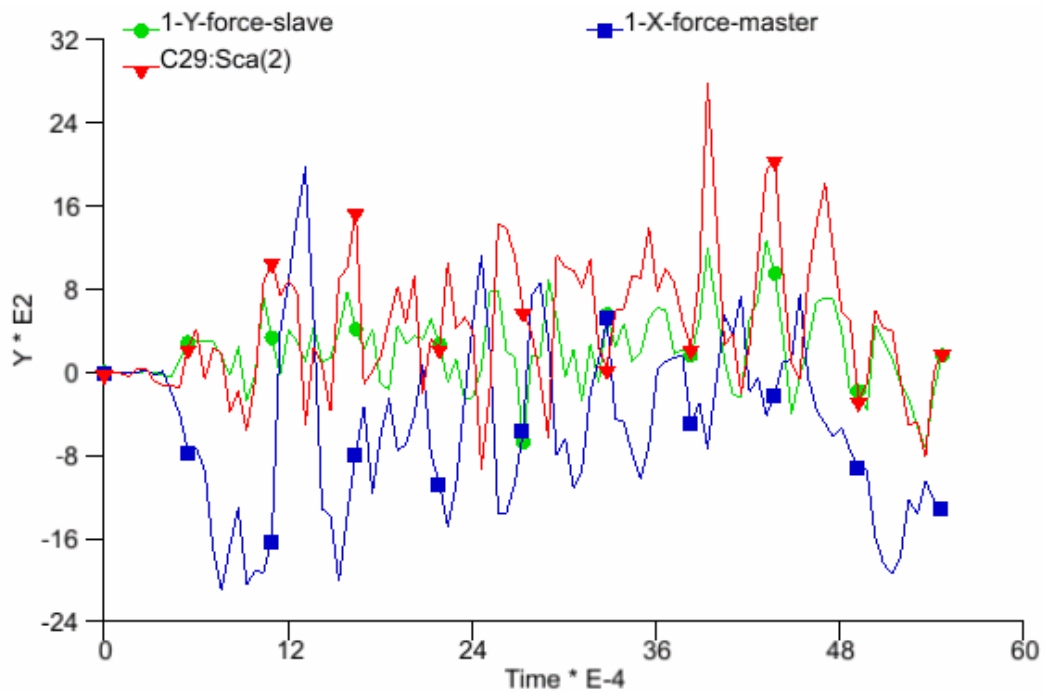

Figure 8.6 An inserted image form clipboard to MS-Word

8.4.3. EXPORT

This function enables the user to export the curves in the current graph window to a DYNIFORM curve file (with the .CUR extension). The program displays the Select File dialog window and prompts the user to enter the file name.

8.4.4. ATTRIBUTE

This function enables the user to change the attributes of the curve. Click the Attribute button to display the control window at the bottom of the graph window. Figure 8.7 shows the functions in the ATTRIBUTE control window.

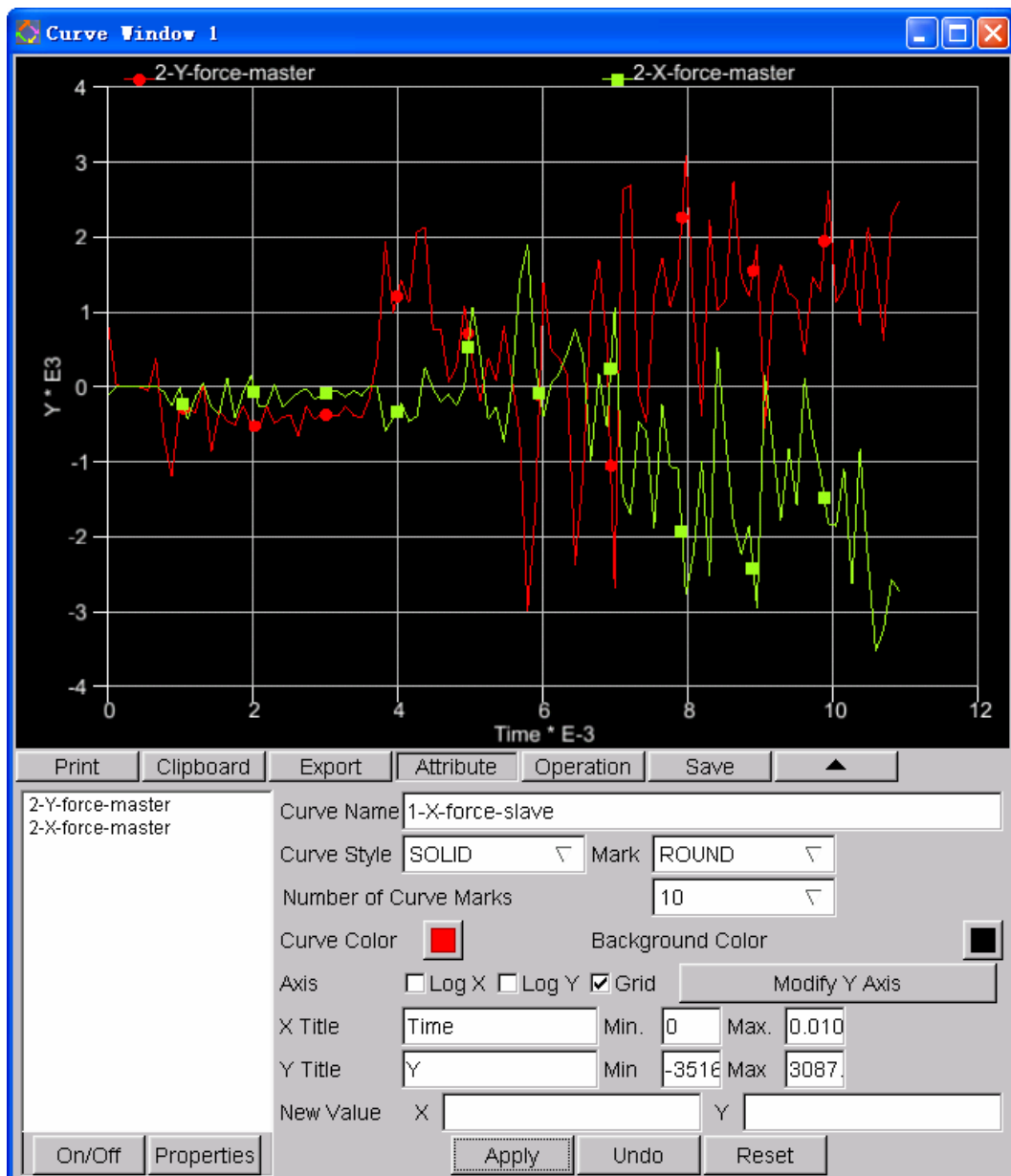

Figure 8.7 Attribute control window

There are many options for the user to change the attribute of the selected curve. The box on the left of the window shows the curve names in the graph window. The user should select a desired curve by clicking the curve name to change its attribute.

1. ON/OFF

This function enables the user to turn on/off the selected curve(s) in the graph window. The user may select a curve by clicking the name in the list or select multiple curves by pressing the SHIFT (range) or CTRL (add) key while clicking the mouse button.

2. PROPERTIES

This function will display a window to present the basic properties (number of points in curve, Min. Y and Max. Y coordinates) of the selected curve. A typical PROPERTIES window is shown in Figure 8.8.

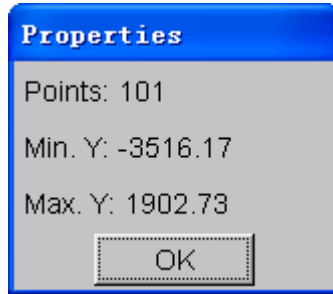

Figure 8.8 Properties window

3. CURVE NAME

This function allows the user to change the name of the curve.

4. CURVE STYLE

This function offers an option for the user to change the line style of the selected curve. There are four styles available for the curve.



The default style is SOLID and the user can press the  button on the right of the text box to select a desired type. Click the APPLY button to update the graph window.

5. NUMBER OF CURVE MARKS

This function offers an option to the user to change the number of curve marks on the selected curve. The user can click  button on the right of the text box to select a desired number (2~15) of curve marks.

6. MARK

This function offers an option to the user to change the type of curve mark. There are six types of curve mark available.

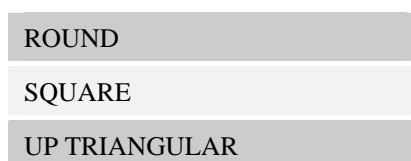

DOWN TRIANGULAR

DIAMOND

NO MARK

The user can press the  button on the right of the text box to select a desired type. Click the APPLY button to update the graph window.

7. CURVE COLOUR

This function allows the user to change the colour of the selected curve. The user clicks the colour box to display the colour panel. Figure 8.9 shows the colour panel. The user may select the desired colour for the curve. If the user does not want to change the colour after the colour panel is displayed, click anywhere outside the colour panel to cancel the operation. Click the APPLY button to update the graph window.



Figure 8.9 Colour panel

8. BACKGROUND COLOUR

This function offers an option for the user to change the background colour of the graph window. The default background colour of the curve window is black. The procedure of changing the background is same as described in CURVE COLOUR function.

9. AXIS OPERATION

The functions in AXIS enable the user to modify the attribute of the axis including Log X, Log Y, Grid display, and change the height of Y axis.

10. LOG X and LOG Y (toggle)

This function enables the user to change the value of coordination with logarithm scale.

11. GRID

This function enables the user to display X and Y grids in the curve. Refer to the Figure 8.7 for a typical graph window with GRID option.

12. MODIFY Y AXIS

This function enables the user to specify the height of the Y-axis in the graph window. Click anywhere along the Y-axis to define the new height. The user can click the Modify button again to cancel the operation.

13. X TITLE

This function offers an option for the user to change the title of X-axis. The X title is labelled below the X-axis.

14. Y TITLE

This function offers an option for the user to change the title of Y-axis. The y title is labelled on the left side of the Y-axis.

15. MIN. MAX. X/Y

This function offers an option for the user to change the range of the X and Y coordinates. The program plots only the portion of the curve(s) within the defined coordinate range.

16. NEW VALUE

This function allows the user to modify the Y value of a selected point. Click a point on a curve to display the x and y coordinate in the corresponding text boxes. The X text box is inactive and can't be modified. The user can modify the value of the Y text box.

8.4.5. OPERATION

The functions in OPERATION control window allow the user to operate on the selected curve. There are 23 types of operations on the curve. These operations are grouped into two categories: curve data operations (such as Integration, Differentiate, Add, etc.) and curve object operations (such as Copy, Delete and Paste, etc.). One or more curves must be selected before selecting the curve operation function. Click the OPERATION button to display the control window as shown in Figure 8.10.

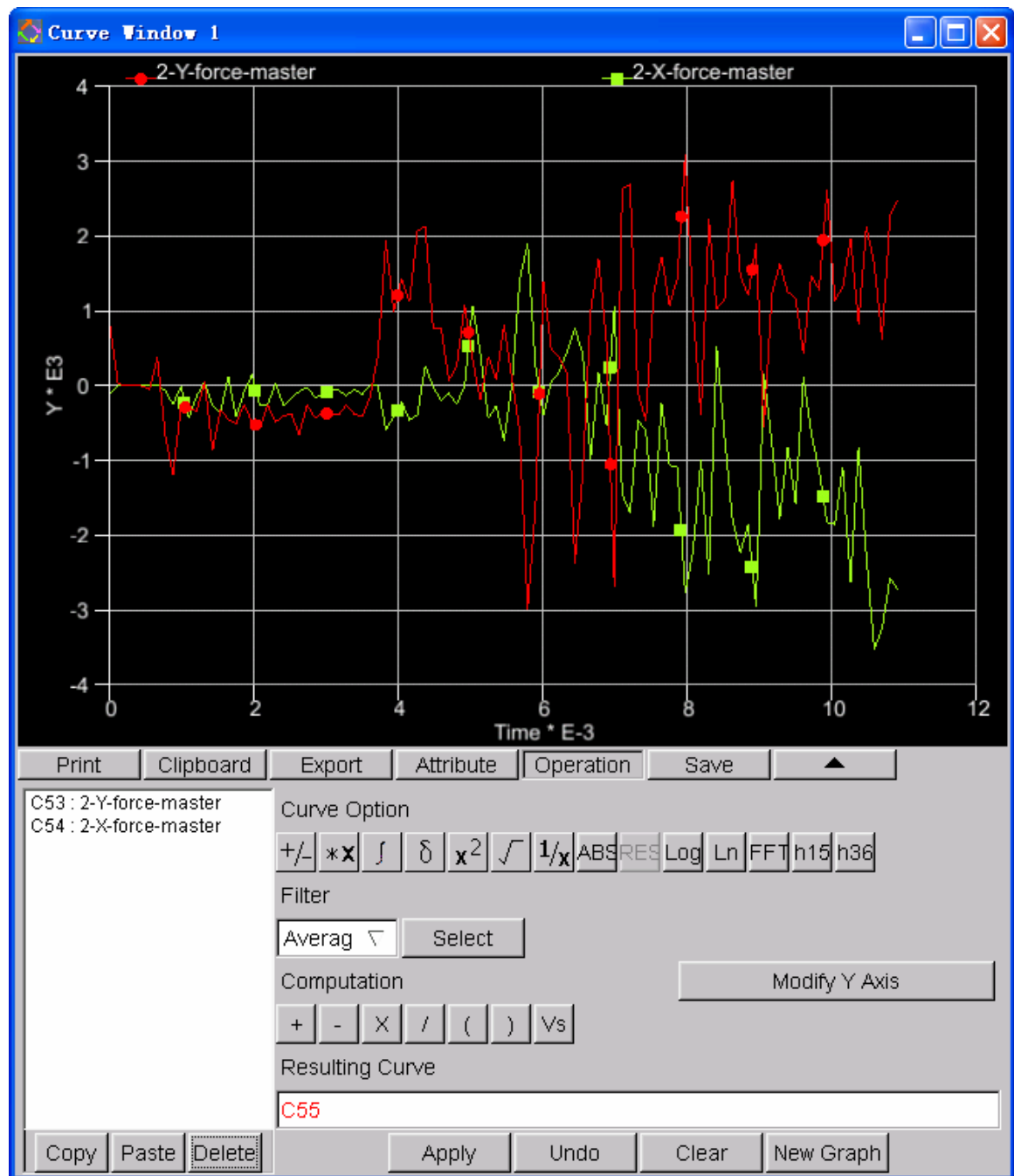

Figure 8.10 Curve Operation window

The curve list box on the left of the Operation window lists the curve names in the current graph window. A unique curve number is assigned to each curve name. The curve number usually starts with a letter and follow with a two-digit number. The user may select a curve by clicking the name in the list or select multiple curves by pressing the SHIFT (range) or CTRL (add) key while clicking the mouse button.

1. CURVE OBJECT OPERATION

- COPY

This function allows the user to copy the selected curve(s).

- PASTE

This function allows the user to paste the copied curve(s) to the current graph window or another graph window.

NOTE: The Copy and Paste functions are not meant for other software such as MS-Word. Use the Clipboard function to paste the graph window to other software.

- DELETE

This function allows the user to delete the selected curve(s) from the current graph window.

2. CURVE OPTIONS

The Curve Options includes 9 types of operation for the selected curve. The option operation is applied to the last selected curve(s). For example, if the user selects a curve from the curve name list window and clicks “1/X” button, the program will perform the reciprocal operation to the Y values of the selected curve.

-  NEGATIVE

This function allows the user to change the Y value of selected curves by multiplying -1.

-  SCALE

This function allows the user to scale the Y value of the selected curve by multiplying a defined scale factor.

-  INTEGRATE

This function allows the user to perform an integral of the selected curve. The new the Y value is equal to the area under the selected curve from the origin to the current X value.

-  DIFFERENTIAL

This function allows the user to perform the derivation of the selected curve. The new Y-axis value is equal to the slope of the curve's tangent on corresponding X point.

-  SQUARE

This function allows the user to apply the square to the Y values of the selected curve.

-  SQUARE ROOT

The function allows the user to take the square root of the Y values of the selected curve. If the Y value is negative, the program will find the square root of the absolute value and maintain the negative sign from the original Y value.

-  RECIPROCAL

This function allows the user to convert the Y values of the selected curve to their reciprocal.

-  ABSOLUTE

This function allows the user to plot the absolute value of the Y values of the selected curve.

-  RESULTANT

This function allows the user to find the square root of the sum of the square of the Y values of the selected curves. The new value $Y_{\text{new}} = \sqrt{Y_1^2 + Y_2^2 + Y_3^2}$. The function is used to plot the vector length from three curves containing the X, Y and Z component. For a two-dimensional vector, only two curves need to be selected. This function will be activated after the user selects more than one curve.

-  LOGARITHM

This function allows the user to plot the logarithm of the Y values of the selected curve. The original Y value should be greater than zero.

-  NATURAL LOGARITHM

This function allows the user to plot the natural (Napierian) logarithm of the Y values of the selected curve.

-  FAST FOURIER TRANSFORM

This function allows the user to convert curve data from time domain to frequency domain response for signal processing analysis. The FFT is a fast algorithm for computing the Discrete Fourier Transform (DFT). The DFT is a basic operation to transform an ordered sequence of data samples from a signal, usually in a time-domain into the frequency-domain. The spectral information about the signal is then represented explicitly. There are various

implementation of FFT when the samples are not of power of two. The algorithms adopted in eta/Post can deal with both cases, whether the number of samples is a power of two or not.

- **h15** HIC 15

This function enables the user to calculate the maximum Head Injure Criteria when the impact time is less than 15 milliseconds. This is a special function used for eta/VPG

- **h36** HIC 36

This function enables the user to calculate the maximum Head Injure Criteria when the impact time is less than 36 milliseconds. This is a special function used for eta/VPG

3. FILTERS

There are four different filters implemented in OPERATION.

Average Filter

Butterworth Filter

Finite Impulse Response (FIR)

SAE

- **AVERAGE**

AVERAGE allows the user to smooth the curve through averaging the value of a point with a number of neighboring points defined by user. The purpose of this operation is to make the curve smoother.

Select the AVERAGE type from the drop down list by clicking the down arrow button in the FILTER text window.

Clicking the SELECT button to display the DATA CONTROL window. The program will prompt the user to enter the number of the points for averaging as shown in Figure 8.11. The user may enter any positive number in the input box, which displays the default value of 10.

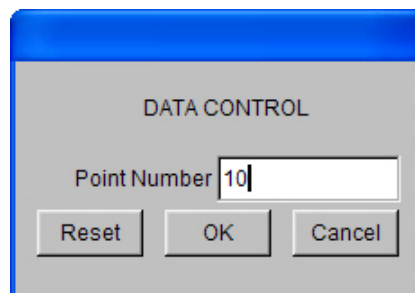

Figure 8.11 DATA CONTROL window of AVERAGE filter

After the user enters an appropriate number, click OK to accept the input value and exit the DATA CONTROL window.

Press APPLY to display the filter result.

- **FIR FILTER**

This function allows the user to smooth the curve according to the Finite Impulse Response (FIR) filter specifications.

Select the FIR type from the drop down list by clicking the down arrow button in the FILTER text window.

Click the Select button to display the DATA CONTROL window. The program will prompt the user to enter the corresponding parameters in the control window. The user may enter any appropriate parameters in the DATA CONTROL windows, which displays the default values as shown in Figure 8.12.

The image shows a dialog box titled "DATA CONTROL" with a blue border. Inside, there are four text input fields stacked vertically. The first field is labeled "Passband" and contains the value "100.000000". The second field is labeled "Stopband" and contains "190.000000". The third field is labeled "Max Ripple" and contains "0.100000". The fourth field is labeled "Min Attenuation" and contains "10.000000". Below these fields are three buttons: "Reset", "OK", and "Cancel", arranged horizontally from left to right.

Figure 8.12 DATA CONTROL of FIR filter

- **PASSBAND FREQUENCY**

The maximum Passband frequency is determined through the equation: $\text{Passbanduser} = (\text{Total Number of Points on Graph/Time Duration})$. The default value is 10% of the Passband frequency.

- **STOPBAND FREQUENCY**

Stopband frequency is defined as: $\text{Stopband} = \text{Passbanduser} + (\text{Passbanmax} - \text{Passbanduser})$. The default value depends on the Passbanduser.

- **MAXIMUM PASSBAND RIPPLE (MAX PASSBRIPP)**

Passband Ripple value is between 0.0 and 1.0 dB.

- MINIMUM STOPBAND ATTENUATION (MIN.ATT.1.0+ DB)

Stopband attenuation must be greater than 1.0 dB. The Stopband frequency and maximum Passband Ripple should not be too close to either the given low- or high-end limits. Attenuation factors commonly range between 10 and 50. It is recommended that the user choose a Passband frequency that is approximately 5 to 20% of the number. Too small a number will cause a computational error and too large a number will cause the program to stall.

After the user enters the appropriate parameters, click OK to accept the input parameters and exit the DATA CONTROL window.

Presses APPLY to display the filter result.

- SAE FILTER

This function allows the user to smooth curves according to the Society of Automotive (SAE) filter specification.

Select the SAE type from the drop down list by clicking the down arrow button in the FILTER text window.

Clicking the SELECT button to display the DATA CONTROL window. The program will prompt the user to enter the Cutoff value as shown in Figure 8.13. The user may enter any appropriate value in the DATA CONTROL window, which displays the default values of 10.

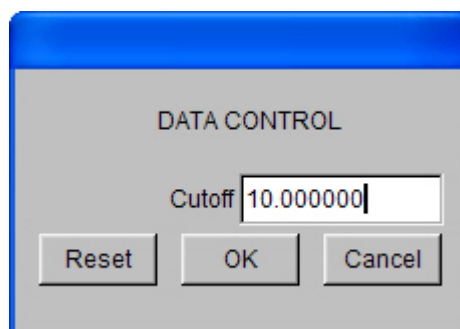

Figure 8.13 DATA CONTROL window of SAE filter

After the user enters the appropriate value, click OK to accept the input parameters and exit the DATA CONTROL window.

Presses APPLY to display the filter result.

- BUTTERWORTH FILTER

This function allows the user to smooth the curves according to the Butterworth filter specifications.

Select the BUTTERWORTH from the drop down list by clicking the down arrow button in the FILTER text window.

Click the Select button to display the DATA CONTROL window. The program will prompt the user to enter the corresponding parameters in the control window. The user may enter any appropriate parameters in the DATA CONTROL window, which displays the default values as shown in Figure 8.14.

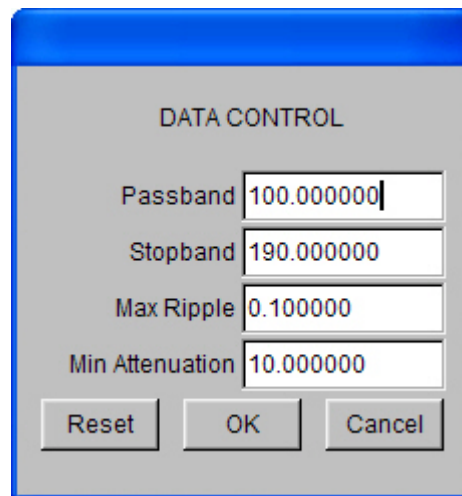

Figure 8.14 DATA CONTROL window of Butterworth filter

- PASSBAND FREQUENCY

The maximum passband frequency is determined through the equation: $\text{Passbanduser} = (\text{Total Number of Points on Graph/Time Duration})$. The default value is 10% of the passband frequency.

- STOPBAND FREQUENCY

Stopband frequency is formulated ; $\text{Stopband} = \text{Passbanduser} + (\text{Passbanmax} - \text{Passbanduser})$. The default value depends on the Passbanduser.

- MAXIMUM PASSBAND RIPPLE (MAX PASSBRIPP)

Passband Ripple value is between 0.0 and 1.0 dB.

- MINIMUM STOPBAND ATTENUATION (MIN.ATT.1.0+ DB)

Stopband attenuation must be greater than 1.0 dB. The Stopband frequency and maximum Passband Ripple should not be too close to either the given low- or high-end

limits. Attenuation factors commonly range between 10 and 50. It is recommended that the user choose a Passband frequency that is approximately 5 to 20% of the number. Too small a number will cause a computational error and too large a number will cause the program to stall.

After entering the appropriate parameters, click OK to accept the parameters and exit the DATA CONTROL window.

Presses APPLY to display the filter result.

4. COMPUTATION

This function allows the user to create a new curve through the algebraic operation of several selected curves including Add, Subtract, Multiply, Divide, etc. The operation in this group usually requires to select a curve prior and after the operation.

-  ADD

This function adds the Y values from two or more curves.

-  SUBTRACT

This function subtracts the Y values of the second curve from the first curve.

-  MULTIPLY

This function multiplies the Y values of the selected curves.

-  DIVIDE

This function divides the Y values of the first curve by the second curve.

-  BRACKET

This functions enables the user to define the left and right brackets to group a series of operations.

-  CROSS PLOT

This function enables the user to make a cross plot of two selected curves. The new X-axis value is obtained from the Y-axis value of the second selected curve and the new Y-axis value from the Y-axis value of the first curve. For example, if the user wants to plot a load deflection curve, he should click the load curve as the first curve and the deflect curve as the

second curve. The program will plot the load as the Y coordinate and deflection as X coordinate in the new curve. It is recommended to plot the cross plot curve to a new graph window to obtain a proper scaling.

5. RESULTING CURVE

The RESULTING CURVE window displays the curve operation expression in real time during the definition process. When user clicks the curve name in the curve name window, the program displays the curve number in the Resulting Curve window. When the clicks a operation button, the program will add the operation symbol in a appropriate location related to the curve number. For example, if the user clicks the first curve name from the curve name window and then clicks “+” (Add) from the computation group and then the second curve name, the program will display $C1 + C2$ in the Resulting Curve window. If the user than clicks the “Square Root” from the Curve Option group, the program will display $C1+C2:Rt()$. This means the program is adding the first curve to the square root of the second curve.

There are two types of colour of the expression in the Resulting Curve window. One is black and another is red. When the colour of the expression is black, it means that the defined operation is valid and the user can press APPLY to perform the operation. If the colour of the expression is red, it indicates that the expression is not correct.

The user may use the UNDO button to erase the last operation. The user may also click the text in the Resulting Curve window and use the keyboard entry to edit the text expression. However the latter method is not very convenient, and is not recommended for the new user.

6. APPLY

This function executes the defined operations as shown in the Resulting Curve window.

7. UNDO

This function allows the user to cancel the last selected operation. The user may click as many UNDO as necessary to correct the defined operation.

8. CLEAR

This function allows the user to erase all the selected operations any time while defining the operation.

NOTE: *During the operation for curves, some curve data operations require the sample frequency and intervals are the same, e.g. binary arithmetic operation. Some other operations require a minimum number of samples e.g. Differentiation, Integration etc. If the user used these operations without following these requirements, an error message box will be resulted.*

NOTE: There are four digital filters as discussed earlier in this chapter. All the filters have the default parameters for convenience. There are two classes of digital filter, non-recursive and recursive. Butterworth filter is the lowpass recursive filter and the FIR and average filter are non-recursive filters. The computation is less for FIR filters than that for Butterworth. However, Butterworth filter gives more power and less signal loss.

9. NEW GRAPH

This function allows the user to create the new graph window to plot the new curve(s). By default, the new curve is plotted in the current graph window when the user clicks APPLY to plot.

8.4.6. SAVE

This function allows the user to save all the curves in current graph window.

APPENDIX A

INDEX FILE FORMAT

2006.1 Version 02

INTRODUCTION

Like the format of LS-DYNA input deck, the file uses keyword input, which provides a flexible and logically organized database that is simple to understand.

The following are some new cards. The others are the same as that in ls-dyna, such as *MAT, *SECTION, *DEFINE_CURVE, etc.

HEADER

Generally, index file contains the following two comments:

\$ eta/DYNAFORM index file (date at time)

\$ KEYWORD VERSION (version number)

for example,

\$ eta/DYNAFORM Index File Jan 9, 2006 at 12:00:44

\$ KEYWORD VERSION 02

*DATABASE_FILE

Purpose: Specify the database file name.

Card Format

Card 1

Variable	FILENAME
Type	C
Default	none

VARIABLE DESCRIPTION

FILENAME File name of database file, 80 characters maximum .

***DATABASE_STATISTICS**

Purpose: Statistics of the database.

Card Format

Card 1 1 2 3 4 5 6 7 8

Variable	NPRT	NND	NEL	NLN	NSRF			
Type	I	I	I	I	I			
Default	0	0	0	0	0			

VARIABLE DESCRIPTION

NPRT Number of parts.

NND Number of nodes.

NEL Number of elements.

NLN Number of lines.

NSRF Number of surfaces.

***DATABASE_UNIT**

Purpose: Specify the unit system.

Card Format

Card 1 1 2 3 - 8

Variable	NUNT		DESCRIPTION
Type	I		C
Default	0		none

VARIABLE DESCRIPTION

NUNT Unit system:

EQ 0: MM, TON, SEC, N

EQ 1: MM, G, MSEC, N

EQ 2: MM, KG, MSEC, KN

EQ 3: M, KG, SEC, N

DESCRIPTION Description of the unit system

*PART_DF

Purpose: Supplement some attributes of part, i.e., combine material information, section properties, FLC. Input is terminated when a "*" card is found.

Card Format

Card 1 1 - 4 5 - 8

Variable	PARTNAME				TOOLNAME			
Type	C				C			
Default	None				none			

Card 2 1 2 3 4 5 6 7 8

Variable	PID	SECID	MID	FLDID				
Type	I	I	I	I				
Default	none	none	none	0				

VARIABLE DESCRIPTION

PARTNAME Name of part

TOOLNAME Name of tool of part

PID Part identification, must be identical with that in dyna input file

SECID Section identification defined in the *SECTION section

MID Material identification defined in the *MAT section

FLDID ID number of FLD, see *DEFINE_FLD.

*DEFINE_FLD

Purpose: Define a FLD (forming limit diagram).

Card Format

Card 1 1 2 3 4 5 6 7 8

Variable	FLDID	LCID	FLD0(E-S)	FLD0(T-S)	N	T	R	
Type	I	I	F	F	F	F	F	
Default	none	0	none	none	none	none	none	

VARIABLE DESCRIPTION

FLDID FLD identification, must be unique

LCID Load curve ID which defines the forming limit curve (FLC).

Minor strains are defined as abscissa values and major strains are defined as ordinate values. In defining the curve list pairs of minor and major strains starting with the left most point and ending with the right most point, see *DEFINE_CURVE.

FLD0(E-S) Minor engineering strain.

FLD0(T-S) Minor true strain

N Work-hardening exponent

T Thickness

R Plastic anisotropy ratio

***DRAWBEAD_DF**

Purpose: Supplement some attributes of drawbead. Input is terminated when a "*" card is found.

Card 1 1 2 3 4 5 6 7 8

Variable	CID	PID	LCIDRF	LCIDNF	DFSCCL			
Type	I	I	I	I	F			
Default	none	none	none	none	1.0			

VARIABLE DESCRIPTION

CID Contact ID of drawbead, must be identical with that in dyna input file

PID ID number of the part attached by the drawbead, see *PART_DF

LCIDRF Load curve ID giving the restraining force

LCIDNF Load curve ID giving the normal force

DFSCS Scale factor for the restraining force curve (LCIDRF)

*DEFINE_POPLINE

Purpose: Define a pop-line.

Card Format

Card 1 1 2 3 4 5 6 7 8

Variable	PLID	LID	PID					
Type	I	I	I					
Default	none	none	none					

VARIABLE DESCRIPTION

PLID Pop-line identification, must be unique

LID ID number for 3D line, see *DEFINE_LINE3D

PID Part ID attached by pop-line, see *PART_DF.

*DEFINE_LINE3D

Purpose: Define a general 3D line.

Card Format

Card 1 1 2 3 4 5 6 7 8

Variable	LID	PID						
Type	I	I						
Default	none	none						

Card 2, 3, 4, etc. Put coordinate per card (3E20.0). Input is terminated when a "*" card is found

Variable	X	Y	Z	
----------	---	---	---	--

Type	F	F	F	
Default	none	none	none	

VARIABLE DESCRIPTION

LID ID number for 3D line, must be unique

PID Part ID, see *PART_DF.

X, Y, Z Coordinates of points on 3D line

***END**

Purpose: Define the termination of the Index file, must be located in the end of the idx file.

APPENDIX B

HARDWARE AND SOFTWARE REQUIREMENTS

- UNIX

PLATFORM	OS VERSION	GRAPHICS CARD	DISK SPACE
HP	HP-UX 11+	Minimum CRX 8 Plane	200 MB
IBM	AIX 4.2+	Minimum 24 Plane Graphics	200 MB
SGI	IRIX 6.5+	All Graphics Boards Supported	200 MB
SUN	SunOS 5.8+	Minimum Creator 3D	200 MB

- LINUX

The RedHat operating system version 7.3 and above is supported. Eta-Post must run under KDE environment. NVIDIA graphic cards are recommended.

- PC/WINDOWS

Eta/Post-Precessor is compatible with LS-DYNA/PC 960 and 970. It will run on Windows 98, 2000, and XP environments. It is not recommended for use with earlier versions of Windows. The following are minimum requirements for proper operation of eta/Post-PC in a Windows environment:

- Minimum Graphics Requirement:

XGA(1024 x 768)

- Graphics Card:

OpenGL based (NVIDIA chip set recommended) or DIRECT 3D (sufficient) with 8 megabytes video RAM.

- Minimum Memory Requirement:

Small model (10,000 - 20,000 elements):	256 MB
Medium model (20,000 - 100,000 elements):	512 MB

Large model (100,00 - 300,000 elements):	768 MB
Huge model (300,000 - 1,000,000 elements):	1GB +

- Minimum Load space requirement:

256 megabytes

- Recommended processor:

Pentium 4 or better

FINAL NOTES

ETA would like to thank all those who helped creating this manual. We have tried to make this manual as accurate as possible. In an effort to keep future versions as error free as possible, we ask that you send us your suggestions and notify us of any errors that you come across. You can contact the ETA software support group at the Troy office via:

Voice: 248-729-3010

Fax: 248-729-3020

E-mail: support@eta.com

Emend Time: June 05, 2006

eta-POST Team

Engineering Technology Associates, Inc.