

**ANSYS**

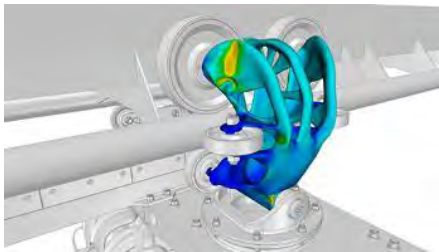

**ESI Group**

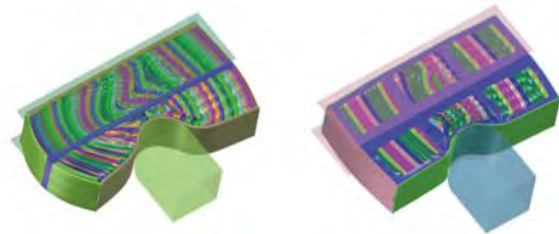

**LST 16th International  
LS-DYNA Conference**



**OASYS  
LS-DYNA Users' Meeting**



**The 16th German LS-DYNA® Forum**





---

## *FEA Information Engineering Solutions*

[www.feapublications.com](http://www.feapublications.com)

The focus is engineering technical solutions/information.

## *FEA Information China Engineering Solutions*

[www.feainformation.com.cn](http://www.feainformation.com.cn)

Simplified and Traditional Chinese

The focus is engineering technical solutions/information.

## **Livermore Software Technology, an ANSYS company**

Development of LS-DYNA, LS-PrePost, LS-OPT,

LS-TaSC (Topology), Dummy & Barrier models and

Tire models for use in various industries.

[www.lstc.com](http://www.lstc.com)

To sign up for the FEA News send an email - subject "subscribe" to [news@feainformation.com](mailto:news@feainformation.com)

To be removed from the FEA News send an email - subject "Remove" to [news@feainformation.com](mailto:news@feainformation.com)

**If you have any questions, suggestions or recommended changes, please contact us.**

**Editor and Contact: Yanhua Zhao - [yanhua@feainformation.com](mailto:yanhua@feainformation.com)**

**Noi Sims – [noi@feainformation.com](mailto:noi@feainformation.com)**

# Platinum Participants

---

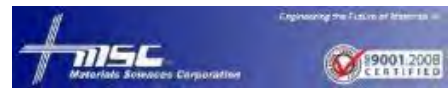
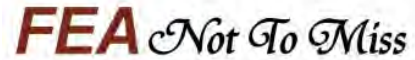
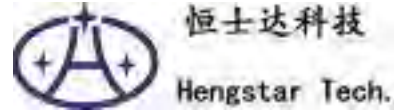

# Table of contents

02 FEA Information Inc. Profile	03 Platinum Participants
04 TOC	05 Announcements

## Articles – Blogs – News

06	ANSYS	How to Improve Designs by Compressing Simulation Analysis
10	BETA CAE Systems	ANSYS Partner: BETA CAE Systems
11	d3View	3VIEW Platform Components
12	DYNAmore GmbH	DYNAmore Online Seminars
14	ESI Group	From Zero to Won in Eight Months
16	ETA	DYNAFORM Version 6.0
17	FEA Not To Miss	LS-DYNA Simulation of the collapse of Takiyya al Sulaymaniyya
18	Hengstar Technology	Online Workshop on the GISSMO Model for Fracture Prediction
19	JSOL	J-OCTA, JSTAMP, J-Composites
20	KAIZENAT	Kaizen-DYNA App
21	LST	LS-TaSC New Release Version 4.1
22	Material-Sciences	Progressive Composite Damage Modeling in LS-DYNA (MAT162 & Others)
23	OASYS	Registration open for the Annual UK Oasys LS-DYNA
24	Predictive Engineering	Western States ANSYS LS-DYNA Distributor
25	Rescale	Modernize your SPDM strategy with Rescale and the Cloud
27	Shanghai Fangkun	Shanghai Fangkun - 2020 Annual Training & Workshop
29	Terrabyte	Products, Sales, Consulting

## Automotive, Resource links, LS-DYNA Training

30	Automotive News - FORD GT SUPERCAR UPGRADED FOR 2020 WITH MORE POWER, NEW SPECIAL EDITION
32	LS-DYNA – Resource Links
33	Training - Webinars
34	LS-DYNA® Training - DYNAmore
35	LS-DYNA® Training - LST

## LS-DYNA New Feature and Application

36	Recent Developments in Time Domain Fatigue Analysis with LS-DYNA®
----	---

## Resources

44	Engineering Solutions	58	ATD - Barrier - THUMS
53	Cloud - HPC Services - Subscription	61	Social Media

# Announcements

---

## 16th International LS-DYNA Conference

May 31 – June 2, Detroit, US

The 16th International LS-DYNA Conference is scheduled to start on the 31st of May, 2020. These conferences are a tradition at LST, LLC. They provide a unique opportunity for LST, LLC developers to meet with customers and for everyone in the LST, LLC community to showcase what they've been doing. This conference includes a banquet, a reception, and an exhibition hall. The primary focus of the conference is the technical presentations. With over 975 attendees in 2018, this conference is an excellent opportunity for networking. A presentation at the LS-DYNA conference will have the attention of LST, LLC developers, product design engineers, industry leaders, consultants, professors, researchers, students, and other interested parties.

**LS-DYNA Conference 2020 website:** <http://www.lstc.com/2020>

## Annual UK Oasys LS-DYNA Users' Meeting

Monday, 30th March 2020

Please join for the 17th Oasys LS-DYNA Users' Meeting, being held at the Ashorne Hill conference centre in Warwickshire on Monday 30th March 2020. Registration open for the UK Oasys LS-DYNA Users' Meeting, March 2020.

**Registration Website:** <https://www.oasys-software.com/dyna/events/uk-users-meeting-2020/>

## 16th German LS-DYNA Forum

October 7 - 9 2020, Ulm, Germany

### Announcement and Call for Papers

The 16th German LS-DYNA Forum will be held on October 7-9 in Ulm, Germany by DYNAMore.

**Abstract submission:** Please submit your abstract (maximum length 2,500 characters) by E-Mail to [forum@dynamore.de](mailto:forum@dynamore.de) or online at: [www.dynamore.de/abstract2020-e](http://www.dynamore.de/abstract2020-e).

**Conference Website:** [www.dynamore.de/forum2020-e](http://www.dynamore.de/forum2020-e)

## LS-TaSC New Release Version 4.1

LS-TaSC Version 4.1 is now available on ANSYS LST ftp. The new features are the Extended Frequency Capabilities and Multidisciplinary Design Optimization.

**New version download:** <http://ftp.lstc.com/user/ls-tasc/v4.1/>



## About ANSYS, Inc.

If you've ever seen a rocket launch, flown on an airplane, driven a car, used a computer, touched a mobile device, crossed a bridge or put on wearable technology, chances are you've used a product where ANSYS software played a critical role in its creation. ANSYS is the global leader in engineering simulation. Through our strategy of Pervasive Engineering Simulation, we help the world's most innovative companies deliver radically better products to their customers. By offering the best and broadest portfolio of engineering simulation software, we help them solve the most complex design challenges and create products limited only by imagination. Founded in 1970, ANSYS is headquartered south of Pittsburgh, Pennsylvania, U.S.A., Visit [www.ansys.com](http://www.ansys.com) for more information.

ANSYS and any and all ANSYS, Inc. brand, product, service and feature names, logos and slogans are registered trademarks or trademarks of ANSYS, Inc. or its subsidiaries in the United States or other countries. All other brand, product, service and feature names or trademarks are the property of their respective owners.

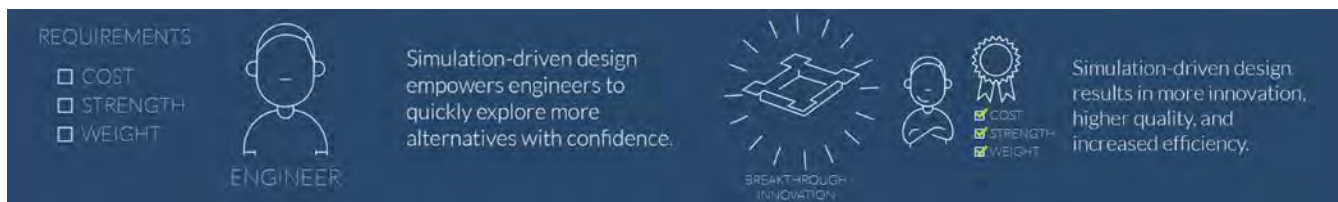

Published on February 5, 2020 by Chad Jackson  
3D Design, Tips and Tricks, Ansys Discovery Live

### How to Improve Designs by Compressing Simulation Analysis

Simulation analysis techniques are established in the world of engineering to expedite innovation and greatly reduce development costs.

These techniques are constantly advancing, and a new range of solutions have emerged, including:

- Multiphysics simulation analysis
- Simulation automation
- Simulation data management
- Simulation-based digital twins on the internet of things (IoT)

We're going to focus on an advancement that has drastically changed the simulation-driven design processes used by engineers around the world: near-real-time simulation analysis.



ANSYS Discovery Live quickly solves thermal mixing scenarios and parametric studies with its new steady-state fluids solver.

### The Traditional Simulation Analysis Process

In a traditional simulation-driven design process, engineers conduct analyses across the entire design lifecycle. During this effort, engineers, or analysts, make changes to the design, run an analysis and make decisions based on the result.

While analysts have used advanced pre- and post-processes and engineers have used simplified computer-aided design (CAD) integrated analysis tools, the design process has essentially been the same for many years.

The main steps of a traditional analysis process are:

1. Create or modify the geometry  
An engineer creates or modifies the geometry of the design. During this step, they could change, simplify or abstract the design.
2. Define loads and boundary conditions  
Once the adjustments to the geometry are complete, the engineer must define the loads and boundary conditions for the simulation. For example, they may define structural loads and thermal constraints.
3. Create or update the mesh  
The engineer or analyst defines the mesh parameters and generates the mesh. The difficulty of this step has been mitigated to an extent thanks to the rise of auto-meshers, which automatically update a mesh based on geometry changes.
4. Select/start the solver  
Engineers need to choose the best solver for the current engineering analysis. The engineer then manually pushes a button to run the process.
5. View and assess results  
The engineer visualizes, interrogates and interprets the analysis results. They then decide whether to run another analysis.



The first step of a traditional simulation analysis is to create or modify the design's geometry.

Because it involves so many manual steps, this analysis process is easily disrupted — undermining the swift review of simulation results.

### The Real-Time Simulation Analysis Process

Several developments have occurred during the last few years that have overhauled the traditional simulation analysis approach — changing it for the better. These advancements have replaced the discrete steps of traditional analysis with a near-real-time process in which the boundaries between steps are blurred.

Click link to the article to watch [“ANSYS Discovery Live produces near instant simulations”](#).

The first two steps (to create or modify the geometry and define loads and boundary conditions) are now the same step. Engineers, or analysts, can vary design parameters and set simulation inputs. In effect, users can define the operating environment of the design while developing the geometry.

Once users provide this information, the next two steps (to create/update the mesh and selecting/starting the solver) are automatically triggered. The initial results are then iteratively presented to the user with increasing accuracy.

No one has to push a button or mesh a model because the entire process is automated and adapts to any changes to the design or simulation inputs.

## What Does Real-Time Simulation Analysis Mean from a User Perspective?

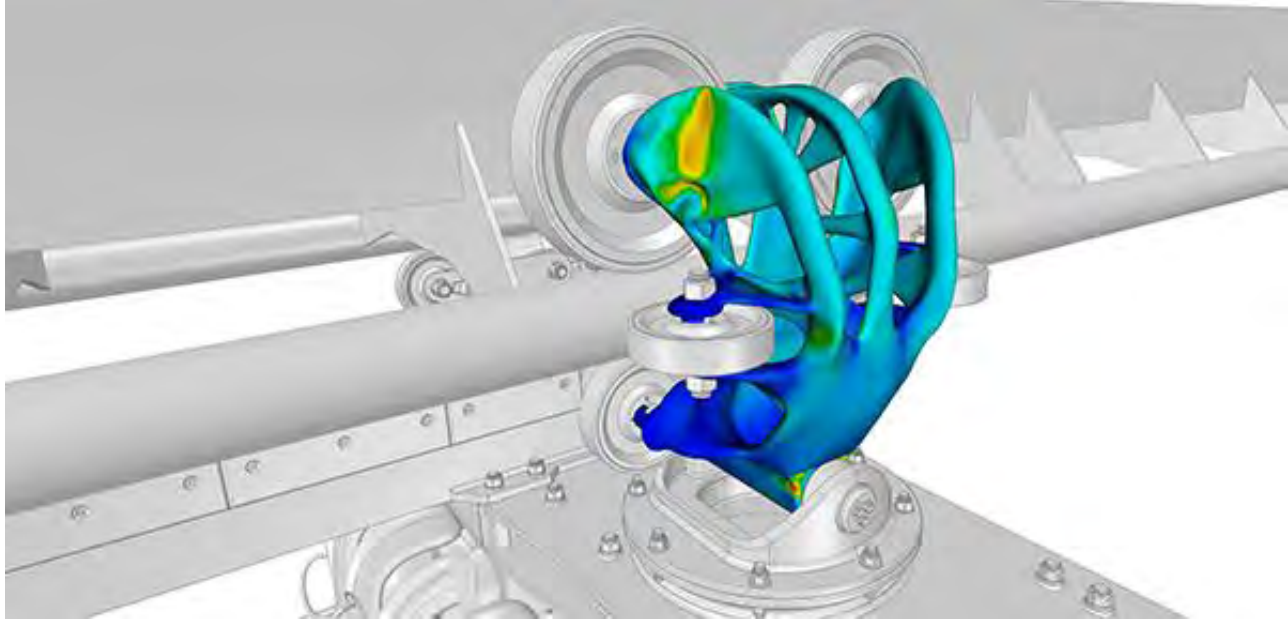

ANSYS Discovery Live introduces an interactive topology optimization tool for generative design.

From a user perspective, real-time simulation analysis offers a lot of flexibility. For instance, while simulation results are emerging, a user can change the design by manipulating the geometry or material selection. They could even change the simulation inputs.

When the analysis is complete, the user can view and assess results continuously. When those results are on the screen, users can make further changes. Then, the simulation results automatically update in response.

This exciting development allows the user to immediately see the effect of changes on design performance. Essentially, engineers and analysts can interact with simulation results in real-time — which facilitates interactive exploration of the design.

Engineers can also gain clear insights into the impact of different design variables on the simulation results, which allows them to make better designs going forward. Because the path to viewing the simulation results is dramatically compressed, users can test more design iterations in shorter time frames. So, this near-real-time analysis leaves more time for innovation as engineers can perform feasibility studies on new concepts.

In short, interactive design exploration allows for rapid product innovation. This results in engineers making better design decisions in less time and empowers organizations to innovate and bring their products to market faster.

To learn more about real-time simulation analysis, read the report: [The Four Benefits of Simulation-Driven Design](#), and the infographic below:





Developing CAE software systems for all simulation disciplines. Products: ANSA pre-processor/ EPILYSIS solver and META post-processor suite, and SPDRM, the simulation-process-data-and-resources manager, for a range of industries, incl. the automotive, railway vehicles, aerospace, motorsports, chemical processes engineering, energy, electronics...



## ANSYS Partner: BETA CAE Systems

BETA CAE Systems, is an engineering software company committed to the development of best-in-class CAE software systems that meet the requirements of all simulation disciplines. Amongst the company's products, the ANSA pre-processor and the  $\mu$ ETA post-processor, hold a worldwide leading position, in many sectors, including the automotive, railway vehicles, aerospace, motorsports, chemical processes engineering, energy, electronics, heavy machinery, power tools, and biomedical.

ANSA is an advanced multidisciplinary CAE pre-processing tool that provides all the necessary functionality for full-model build up, from CAD data to ready-to-run solver input file, in a single integrated environment for numerous analysis codes. It is the users' preference due to its wide range of features and tools that meet their needs. The list of productive and versatile features is long and the alternative tasks and processes to be completed using them are countless. Its functionality spans from data translators, clean up and assembly to batch meshing, model completion, check and solution scenario definition. Integrated with Data Management, Task Management, and scripting language among other tools, it offers a unique productive modeling environment.

Among the benefits that the ANSA pre-processor offers to CAE engineers the most important are:

- efficient data handling for intricate model structures
- fast and high quality modeling of complex geometries
- capability to interoperate between models built for different solvers
- highly automated processes and model set-up tools in one environment
- reduced user-dependent error-prone operations
- complete model build-up for numerous solvers in one environment
- unique capability for building a common model as a basis for modeling for different disciplines
- significant modeling time reduction and quality increase
- short learning curve and deployment time

$\mu$ ETA, is a multi-purpose CAE post-processing software that provides a broad range of functionality for analyzing and reporting results coming from numerous solvers. It incorporates innovative features, such as: customizable interface, high-performance graphics, 2D-plots coupled with 3D results, handling of multiple models, synchronization of video with model animation, linear combinations of results, built-in computations, annotations etc.

Some of the benefits offered by the  $\mu$ ETA post-processor include the following:

- a single tool for 3D, 2D post-processing, for all disciplines
  - high level of automation for all processes. until report generation
  - high performance of results reading and graphics display
  - low memory footprint
  - pre-configured discipline specific toolbars
  - prompt software updates for the support of the latest solver results versions
  - synergy with ANSA
  - direct coupling with optimizers
  - short learning curve and deployment time
- ANSYS, Inc (and its subsidiaries) and BETA CAE Systems are in a long lasting co-operation which targets to the development of high quality pre- and post-processing solutions for its products: ANSYS®Structural™, ANSYS® CFX® and FLUENT®.

### Regions Served

Asia Pacific, Europe, MEA, North America, South America

d3VIEW is a data to decision platform that provides out-of-the box data extraction, transformation and interactive visualizations. Using d3VIEW, you can visualize, mine and analyze the data quickly to enable faster and better decisions.



## d3VIEW Platform Components

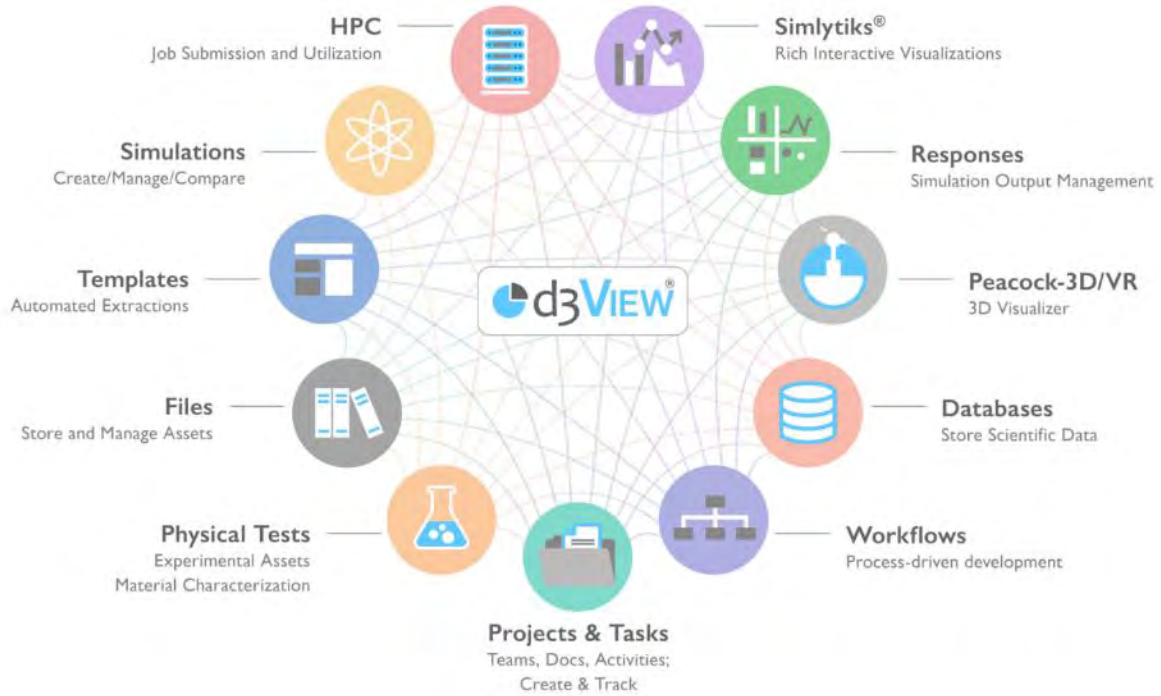

d3VIEW  
Built-In  
Automotive  
Templates

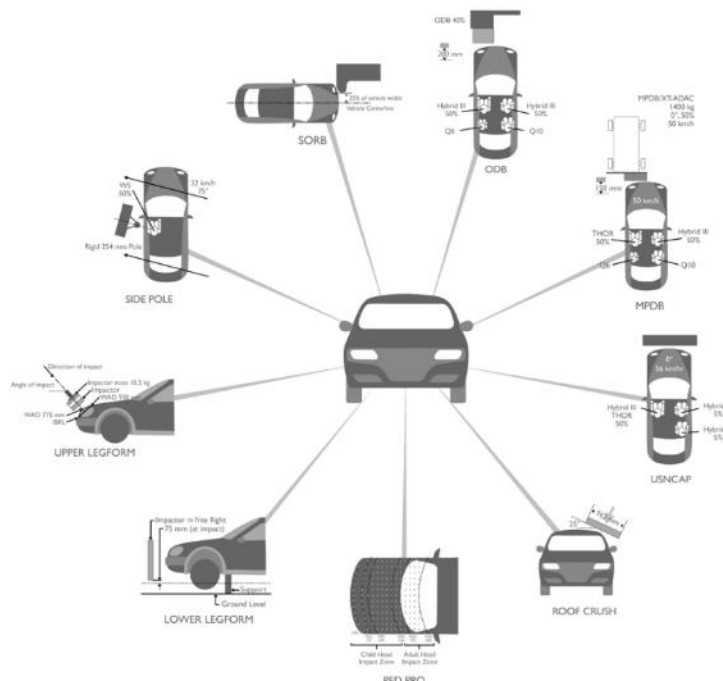

[www.d3view.com](http://www.d3view.com)

For more information email  
[info@d3view.com](mailto:info@d3view.com)



## Announcement and Call for Papers

# 16<sup>th</sup> German LS-DYNA Forum October 7 - 9 2020, Ulm, Germany

Conference Website: [www.dynamore.de/forum2020-e](http://www.dynamore.de/forum2020-e)

### Call for Papers

we kindly invite you to participate at the 16th German LS-DYNA Forum and encourage you to actively contribute to the conference agenda by submitting a presentation about your experience with LS-DYNA, LS-OPT or LS-TaSC. Participation without a presentation is also worthwhile to exchange your knowledge and discuss new solution approaches with other users.

Besides presentations from users, there will be also selected keynote lectures of renowned speakers from industry and universities as well as developer presentations. The popular workshops on various topics will also be continued.

We hope that we have stimulated your interest and are looking forward to receiving your abstract and to seeing you in Ulm.

### Conference languages

German and English

### Venue

Maritim Hotel and Conference Center Ulm

Address:  
Maritim Hotel  
& Congress  
Centrum Ulm  
Basteistraße 40  
D-89073 Ulm  
Germany



### Directions

Ulm can be reached easily via the airports Frankfurt, Munich and Stuttgart. From the airports are connections with the train ICE.

### Abstract submission

Please submit your abstract (maximum length 2,500 characters) by E-Mail to [forum@dynamore.de](mailto:forum@dynamore.de) or online at: [www.dynamore.de/abstract2020-e](http://www.dynamore.de/abstract2020-e)

*Please note: A full paper is not required, only a 2-page extended abstract.*

### Important Dates

Abstract submission: 29 May 2020  
Author notification: 3 July 2020

Two-page abstract: 7 September 2020

### Participant fees

Industry speaker: 400 Euro

Academic speaker: 300 Euro

Industry: 575 Euro<sup>1)</sup> / 625 Euro

Academic: 380 Euro<sup>1)</sup> / 430 Euro

<sup>1)</sup> Registration before 26 June 2020. All plus VAT.

### Exhibiting and sponsoring

Please request further information.

### Contact

DYNAmore GmbH

Industriestr. 2, D-70565 Stuttgart, Germany

Tel. +49 (0) 7 11 - 45 96 00 - 0

E-Mail: [forum@dynamore.de](mailto:forum@dynamore.de)

[www.dynamore.de/forum2020-e](http://www.dynamore.de/forum2020-e)

## DYNAmore Online Seminars



### “Crashworthiness Simulation with LS-DYNA” and “Introduction to LS-DYNA” online available

More information: [www.dynamore.de/c2011e](http://www.dynamore.de/c2011e)  
and [www.dynamore.de/c2076e](http://www.dynamore.de/c2076e)

## Material Competence Center moves into new

### “Crashworthiness with LS-DYNA”

With this course we are expanding our range of services and offering a seminar online. This gives interested users the opportunity to follow the course on their own computers and at their own convenience. The 4-day seminar with Paul Du Bois was recorded as a video and divided into 15 chapters. The content of the course is therefore identical to that of the seminar in Stuttgart.

### Registration

Please register via our website as you would for a conventional seminar. After we have received your payment we will send you a link and a password with which you can view the course. We will send you the seminar documents by regular mail.

[www.dynamore.de/c2011e](http://www.dynamore.de/c2011e)

Please note that for security reasons, each chapter of the course may only be completed once and the password loses its validity after 14 days.

We hope that the offer will appeal to you and look forward to many registrations. If you have any questions about this course, please do not hesitate to contact us.

### Contact

DYNAmore GmbH  
Industriestr. 2, D-70565 Stuttgart, Germany  
Tel. +49 (0) 7 11 - 45 96 00 - 0  
E-Mail: [forum@dynamore.de](mailto:forum@dynamore.de)  
[www.dynamore.de](http://www.dynamore.de)

### “Introduction to LS-DYNA”

From April 1, 2020, our new online seminar "Introduction to LS-DYNA" will be available. The course corresponds exactly to the seminar in Stuttgart, where we recorded all three days recently. The registration is already possible on our website. [www.dynamore.de/c2076e](http://www.dynamore.de/c2076e)

We will inform about new online seminars in the FEA Newsletter and in the DYNAmore Infomail (Registration: [www.dynamore.de/infomail-e](http://www.dynamore.de/infomail-e)).

Please note that all courses are only available to members of companies. Students and private persons are excluded from use.



Courtesy of Daimler AG



A leading innovator in Virtual Prototyping software and services. Specialist in material physics, ESI has developed a unique proficiency in helping industrial manufacturers replace physical prototypes by virtual prototypes, allowing them to virtually manufacture, assemble, test and pre-certify their future products.

## From Zero to Won in Eight Months

### Farasis Dominates Bidding Process from a German OEM Thanks to a Virtual Prototype of Their Electric Battery That Surpasses Expectations

Friday, January 31, 2020 By Natasha Baccari



#### A New Player Enters the EV Game

The move of the automotive industry toward electrification is seemingly unstoppable. OEMs are announcing aggressive plans for Electric Vehicle (EV) production, and the International Energy Agency says the number of EVs will grow from 3 to 125 million by 2030. So, it's no wonder that new players are entering the market, breaking the traditional rules of product design – new players like lithium-ion battery maker Farasis Energy. Looking to collect wins in this fast-growing market, the team at Farasis was able to gain the expertise and [Virtual Prototyping](#) capabilities to prove to a major German OEM that they were the best supplier – based solely on a virtual prototype. But how did they go from little simulation knowledge to won in just a few months?

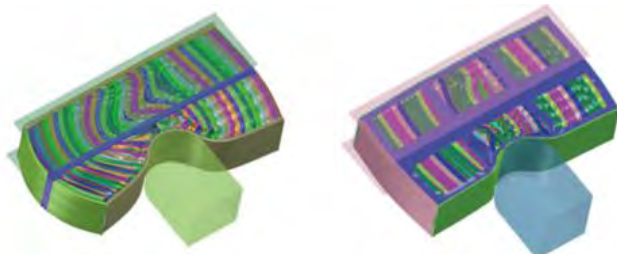

Battery crush simulation analyses, using ESI Virtual Performance Solution, before (left) and after (right) design improvements show less damage. Courtesy of Farasis Energy.

#### OEM Says “No Thank You” to Physical Testing

Farasis Energy, Inc., founded in California in 2002, is a developer and supplier of Li-ion battery technologies. With headquarters in China, a technology research center in Silicon Valley, and several large-scale manufacturing plants in Asia and Europe, they are leaders in the industry. Witnessing the exponential growth of the EV market, Farasis saw an opportunity to expand their business. We spoke to Dr. Matt Klein, Manager for Engineering Analysis and Modeling at Farasis, who told us about his company's experience bidding for a large German automotive OEM.

Early in 2018, they received a development request for a new battery module from a German OEM. Bidding for a new battery design typically requires physical testing along with virtual testing (i.e. simulation). Farasis knew they would be working within a very short timeframe. Indeed, to bring EV to market faster, safer, and better than their competition, OEM and suppliers need to validate the reliability of their vehicles and parts faster than ever. This OEM accelerated the program timeline even further. Dr. Klein recalls, “Half-way through the bidding process, the OEM actually decided to remove the physical prototype step – they would make their decision based on the virtual prototype.”

## Multi-Domain Simulation for the Win

Klein and his team were not caught off guard as they had teamed up with ESI, relying on the software provider's proven knowledge of the automotive industry and ability to provide real results, virtually, thanks to virtual prototyping. He describes ESI's combination of domain expertise and solution capabilities as crucial to the project's success. The ability to work with a single-core model and test it in all engineering domains without wasting time converting models across more-or-less compatible software environments allowed Farasis to iterate much more efficiently and tailor a robust, cost-effective design to the OEMs stringent crush, shocks, and resonance tests criteria.

In just 8 months, we went from limited Virtual Prototyping capability to winning those bids. The head of the whole program conducting the bidding process went out of his way to tell us that the mechanical simulation was an instrumental part in helping us get the design approved. We could not have done that without ESI. Our partnership with ESI is truly strategic in bringing our simulation capabilities to a global leading standard." Dr. Matt Klein, Manager for Engineering Analysis and Modeling, Farasis Energy, Inc.

## An Evolving Partnership

ESI is now putting in place a platform for Farasis' international team of CAE engineers, one that is fully automated and customized to their way of working. Thanks to this platform, the Farasis team will work together - regardless of what continent they are on - with great efficiency and transparency, on common Virtual Prototyping models. And what began as a bilateral partnership has quickly evolved into an ecosystem comprised of three major players – Farasis, ESI Group, and the automotive OEM – all hungry to tap into the EV market. Since their win, business is booming in Germany and China and in his new role as Global CAE Director, Klein plans to create a robust, global simulation team with the help of ESI.

We are keeping Farasis in our sights – and so should you.

For more information visit: [Future of Mobility](#) and [Virtual Prototyping](#)

---

## About ESI Group

ESI Group is a leading innovator in Virtual Prototyping software and services. Specialist in material physics, ESI has developed a unique proficiency in helping industrial manufacturers replace physical prototypes by virtual prototypes, allowing them to virtually manufacture, assemble, test and pre-certify their future products. Coupled with the latest technologies, Virtual Prototyping is now anchored in the wider concept of the Product Performance Lifecycle™, which addresses the operational performance of a product during its entire lifecycle, from launch to disposal. The creation of a Hybrid Twin™, leveraging simulation, physics and data analytics, enables manufacturers to deliver smarter and connected products, to predict product performance and to anticipate maintenance needs.

ETA has impacted the design and development of numerous products - autos, trains, aircraft, household appliances, and consumer electronics. By enabling engineers to simulate the behavior of these products during manufacture or during their use, ETA has been involved in making these products safer, more durable, lighter weight, and less expensive to develop.



## DYNAFORM

DYNAFORM is a simulation software solution, which allows organizations to bypass soft tooling, reducing overall tryout time, lowering costs, increasing productivity & providing complete confidence in die system design. It also allows for the evaluation of alternative and unconventional designs & materials.

### DYNAFORM Version 6.0 is Now Available!

DYNAFORM 6.0 is the sixth-generation DYNAFORM product. It provides a user-friendly and intuitive interface with a streamlined design. The analysis process is fully based on the stamping process, which requires less CAE knowledge, and minimum geometry and element operations. This latest release offers the following features and improvements:

- Intuitive and Streamlined Interface
- Tree Structure to Manage Operation
- Simulation Data Manager
- Customized Icons Grouping for Drop-down Menu Functions
- Separate and Independent Application
- Unified Pre and Post Processing
- Multi-Window View
- Access Functions Using Right Mouse Button Clicks
- Supports Large Forming Simulation Models
- Geometry Manager
- Process Wizard for Blank Size Engineering

- Minimum Geometry and Elements Operations
- New Material Library Window
- New Drawbead Shape and Library
- Coordinate System Manager
- Instant Section Cut
- Tata Steel FLD
- Balloon Label
- PowerPoint and Excel Based Automatic Formability Report Generation

[Click Here to website](#)

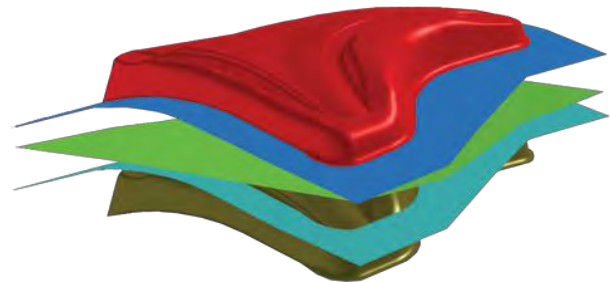



FEA Not To Miss, is a weekly internet blog on helpful videos, tutorials and other Not To Miss important internet postings. Plus, a monthly email blog.



Start your Monday with coffee or tea reading our engineering blog, at the FEA Not To Miss coffee shop. Postings every Monday on what you have missed

[www.feantm.com](http://www.feantm.com)

**Monday 02/17/2020** - I know where I don't want to be standing drinking my coffee! The simulation below is earthquake - All I can think of is RUN! Now, that is scary!



[LS-DYNA Simulation of the collapse of Takiyya al Sulaymaniyya](#) under earthquake loads has been done in LS-DYNA.

**Monday 02/10/2020** - Well, now I know what my car will look like if I run into one of the below wires. But my vehicle starts yelling at me if I go off the line it wants. It shakes the wheel; it screams - COFFEE USE BRAKE! COFFEE WATCH LANE - you would think it wants to own a coffee shop and has its flavors picked out!



[Car impact into wire rope safety barrier](#)

**Simulation of an impact of a 900 kg car to a wire rope safety barrier. The situation is similar to an EN1317 TB11 test.**

**Monday 12/30/2019** - Coffee Le LEGO Week. I love these LEGO simulations, slinky, toys, planes. WAIT - it seems I love all of them with coffee. And we are also heading to 2020 Coffee Year!

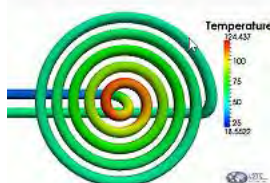

[LS-DYNA conjugate heat transfer in a coil heated by an electric current](#)

Predicting the temperature of the coil to which a current is applied.

Shanghai Hengstar & Enhu Technology sells and supports LST's suite of products and other software solutions. These provide the Chinese automotive industry a simulation environment designed and ready multidisciplinary engineering needs, and provide a CAD/CAE/CAM service platform to enhance and optimize the product design and therefore the product quality and manufacture.



## Online Workshop on the GISSMO Model for Fracture Prediction



Shanghai Enhu & Hengstar Technology organized an open online workshop for the CAE engineers about “The GISSMO Model for Fracture Prediction” on Jan 10th, 2020. The purpose of this workshop was to help better understand the GISSMO model and its applications. The content of this workshop included engineering approach for instability failure, failure criterion for plane stress, and generalized incremental stress state dependent damage model. Besides, identification of the GISSMO damage parameters using LS-OPT was introduced.

More than 40 CAE engineers attend this online workshop. After presentation and discussion, all attendees agree that the workshop was held timely and successfully.



### Contact us for our LS-DYNA training courses and CAD/CAE/CAM consulting service, such as

- Crashworthiness Simulation with LS-DYNA
- Restraint System Design with Using LS-DYNA
- LS-DYNA MPP
- Airbag Simulation with CPM
- LS-OPT with LS-DYNA

**Our classes** are given by experts from LSTC USA, domestic OEMs, Germany, Japan, etc. These courses help CAE engineers to effectively use CAE tools such as LS-DYNA to improve car safety and quality, and therefore to enhance the capability of product design and innovation.

**Consulting** - Besides solver specific software sales, distribution and support activities, we offer associated CAD/CAE/CAM consulting services to the Chinese automotive market.

**Solutions** - Our software solutions provide the Chinese automotive industry, educational institutions, and other companies a mature suite of tools - powerful and expandable simulation environment designed and ready for future multidisciplinary CAE engineering needs.

Shanghai Hengstar provides engineering CAD/CAE/CAM services, consulting and training that combine analysis and simulation using Finite Element Methods such as LS-DYNA.

Shanghai Hengstar Technology Co., Ltd

[hongsheng@hengstar.com](mailto:hongsheng@hengstar.com)

<http://www.hengstar.com>

Shanghai Enhu Technology Co., Ltd

<http://www.enhu.com>

JSOL

JSOL supports industries with the simulation technology of state-of-the-art. Supporting customers with providing a variety of solutions from software development to technical support, consulting, in CAE (Computer Aided Engineering) field. Sales, Support, Training.

## J-OCTA®

Integrated Simulation System for Soft Materials.

J-OCTA, an integrated simulation system for polymeric material, is widely used in material R&D Center of Industry and University. J-OCTA predicts material properties with multi-scale simulation technology (from atomic to micrometer scale) and supports the development of wide variety of high functional materials.

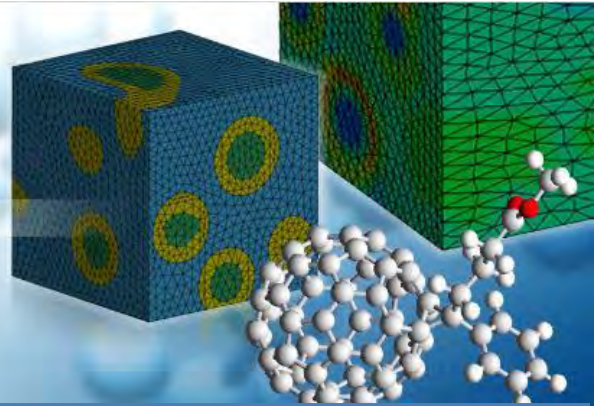

Support tool design and process design for forming  
Integrated forming simulation system JSTAMP  
Sheet metal forming Simulation

## JSTAMP®

- Dieface Design Support
- Blankline/trim line development
- Crack, wrinkle, and springback prediction
- CAD output of SB-compensated tool
- Material database as standard equipment

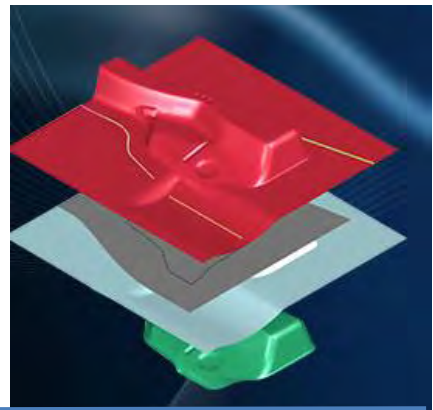

## J-Composites partners - Dec 09, 2019 NEW

**Mitsubishi Chemical Corporation:** Cooperation in standard material database for Form Modeler

**Toray Industries, Inc.:** Cooperation in standard material database for Form Modeler



Supports a variety of composite material forming processes  
Modelling tool for LS-DYNA composite forming simulation

## J-Composites®

- Ease complex and difficult composite material model creation
- User-friendly interface
- Advanced computer simulation by using the multi-purpose solver LS-DYNA
- Auto-conversion of material test data into material parameters
- Stiffness analysis that considers various forming factors

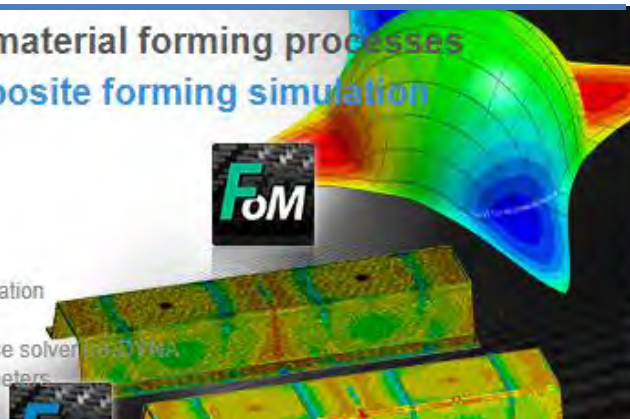

KAIZENAT Technologies Pvt Ltd is the leading solution provider for complex engineering applications and is founded on Feb 2012 by Dr. Ramesh Venkatesan, who carries 19 years of LS-DYNA expertise. KAIZENAT sells, supports, trains LS-DYNA customers in India. We currently have office in Bangalore, Chennai, Pune and Coimbatore.



## Kaizen-DYNA App

"Kaizen-DYNA" is a mobile and web based application which is built by Kaizenat Technologies Private Limited (KTPL) to help LS-DYNA users across the world.

This powerful application helps LS-DYNA users across the world to stay connected and also help each other by sharing their knowledge.

The key feature of this application is QUERY and RESPONSE. Where a user can post and respond to queries. The best response for each query will be rewarded with a Kaizen score.

This application also gives an opportunity for the employers to float their LS-DYNA job openings and alert its user's base with a notification.

"Kaizen-DYNA" quiz program can help LS-DYNA users to update their knowledge score and trend top in the job seekers list.

It also gives an opportunity for new users to learn LS-DYNA with training materials FAQ modules.

This application also brings latest news about LS-DYNA and some useful general information.

### OFFICE LOCATIONS

#### Chennai

14, Gandhi Main Road Shankar Nagar, Pammal  
Chennai - 600075

#### Bangalore

B-1112, Signature Tower, Brigade Golden  
Triangle, Old Madras Road, Kattanallur Gate,  
Bangalore - 560049

#### Pune

305, A wing, Aishwaryam courtyard, Near sane  
chowk, Akurdi-chikali road, Pimpri Chinchwad,  
Pune - 411062

#### Contact

Email : [support@kaizenat.com](mailto:support@kaizenat.com)  
Phone : +91 80 41500008



A team of engineers, mathematicians, & computer scientists develop LS-DYNA, LS-PrePost, LS-OPT, LS-TaSC, and Dummy & Barrier models, Tire models.

## LS-TaSC New Release Version 4.1

### LS-TaSC Version 4.1 provides new features as follows:

**Extended Frequency Capabilities:** Frequency constraints have been implemented for a single eigenvalue load case. The eigen mode tracking feature is available for frequency constraints. A typical design of maximizing fundamental eigenfrequency with one or more frequency constraints on the target eigen modes (e.g. first bending/torsion mode) can be addressed. *Solid elements* including linear hexahedrons, pentahedral and tetrahedral, and \*CONSTRAINED\_NODAL\_RIGID\_BODY keyword, are supported for frequency design.

**Multidisciplinary Design Optimization:** Projected Subgradient Method in co-operation with the multipoint scheme and spatial kernels [Ref. 1 – 3] is developed as the main solver to address constrained multidisciplinary topology optimization problems in combination with crash, NVH, and statics load cases. This solver is motivated for a high performance of computing huge models with more than 10 million elements.

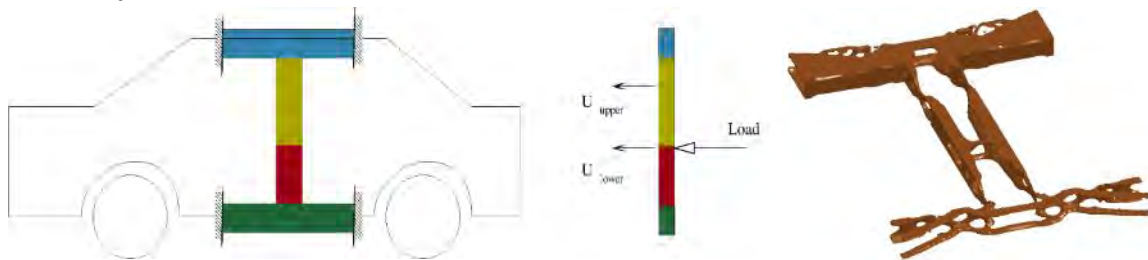

Simplified side impact design problem

Final design of B-pillar

Animation of the design iterations is available to display the iterative designs and be saved in different formats. Iterative design data of optimization history plots are allowed to be exported for further usage.

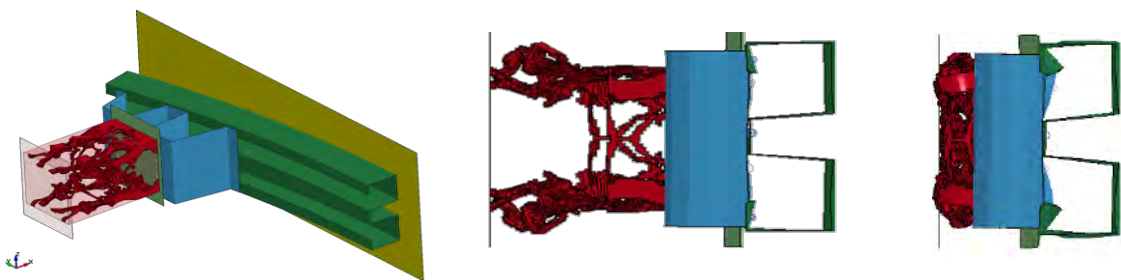

Final design of crash box

Deformation at t=12 ms

Deformation at t=20 ms

### References:

- [1] Roux W, Yi GL, and Gandikota I, Implementation of projected sub-gradient method in LS-TaSC. 15<sup>th</sup> International LS-DYNA User's Conference, Jun 10-12, 2018, Detroit.
- [2] Gandikota I, Yi GL, and Roux W, Crashworthiness and lightweight optimization of an automotive crash box using LS-TaSC. FEA Information Engineering Solutions, 2019.
- [3] Roux W, Yi GL, and Gandikota I, A spatial kernel for topology optimization. Computer Methods in Applied Mechanics and Engineering, 361: 112794, 2020.

New version download: <http://ftp.lstc.com/user/ls-tasc/v4.1/>

Providing engineering services to the composites industry since 1970. During this time, we have participated in numerous programs that demonstrate our ability to perform advanced composite design, analysis and testing; provide overall program management; work in a team environment; and transition new product development to the military and commercial sectors.



## Progressive Composite Damage Modeling in LS-DYNA (MAT162 & Others)

Bazle Z. (Gama) Haque, Ph.D.

Senior Scientist, University of Delaware Center for Composite Materials (UD-CCM)  
Assistant Professor of Mechanical Engineering, University of Delaware, Newark, DE  
19716 P: (302) 690-4741 | E: [bzhaque@udel.edu](mailto:bzhaque@udel.edu)

### 2020 Workshops

Webinar Course Dates

March 10, 2020

July 14, 2020

November 17, 2020

In House Course Dates

March 11, 2020

July 15, 2020

November 18, 2020

Cost:

In-House Class: \$695 per person

*Includes: Coffee, Lunch, Parking, USB with Course Content*

email [Corinne Hamed](mailto:Corinne.Hamed) for driving direction

Web Conference: \$695 per person

*Includes: CD with Course Content*

### Description:

Progressive damage modeling of composites under low velocity impact, and high velocity impact is of interest to many applications including car crash, impact on pressure vessels, perforation and penetration of thin and thick section composites. This course will provide a comparison between available composite models in LS-DYNA for shell and solid elements, e.g., MAT2, MAT54, MAT59, & MAT162. Among these material models, rate dependent progressive composite damage model MAT162 is considered as the state of the art. This short course will include the theory and practice of MAT162 composite damage model with applications to low and intermediate impact velocities, understanding the LS-DYNA programming parameters related to impact-contact, damage evolution, perforation and penetration of thin- and thick-section composites. Printed copies of all lecture notes will be provided along with a CD containing all example LS-DYNA keyword input decks used in this short course.

Topics Covered in this Short Course:

Impact and Damage Modeling of Composites

Application of MAT162 in Engineering and

Research Problems

Introduction to Composite Mechanics

Introduction to Continuum Mechanics and

Composite Mechanics

Composite Material Models in LS-DYNA for

Shell and Solid Elements

Discussion on MAT2, MAT54, MAT59, &

MAT162

Theory and Practice in MAT162 Progressive

Composite Damage Model for Unidirectional and

Woven Fabric Composites

MAT162 User Manual – Version 15A 2015

Progressive Damage Modeling of Plain-Weave

Composites using LS-Dyna Composite Damage Model MAT162

Unit Single Element Analysis

Comparison between Different LS-DYNA

Composite Models

Sphere Impact on Composite SHELL & SOLID Plates

Low Velocity Impact and Compression after Impact Applications

Modeling the Low Velocity Impact and Compression after Impact Experiments on

Composites Using MAT162 in LS-DYNA

Perforation Mechanics of 2-D Membrane and Thin Composites

Penetration Mechanics of Composites and Soft-Laminates

Introduction to LS-DYNA (Document Only)

To register, email [Corinne Hamed](mailto:Corinne.Hamed) your full name, and if you're attending in house or web conference.

Oasys Ltd is the software house of Arup and distributor of the LS-DYNA software in the UK, India and China. We develop the Oasys Suite of pre- and post-processing software for use with LS-DYNA.



## Registration open for the Annual UK Oasys LS-DYNA Users' Meeting Monday, 30th March 2020

Please join us for the 17th Oasys LS-DYNA Users' Meeting, being held at the [Ashorne Hill](#) conference center in Warwickshire, UK.

We are excited to announce some of the new features in the Oasys LS-DYNA Environment that will be demonstrated at this event:

We look forward to seeing you at our event!  
Please register [here](#).



## Webinars 2020

### Oasys and LS-DYNA team offers several free webinars

These are delivered by our software experts and provide opportunity to listen and ask questions from the comfort of your own desk.

You may now view ICFD webinar on our YouTube channel [here](#).

Next upcoming webinars:

- 4<sup>th</sup> March [LS-OPT part 2](#)
- 1 April [Oasys Post: customization](#)
- 7 May [Advanced LS-DYNA Implicit](#)

To view past and future webinars click [here](#)

Predictive Engineering provides FEA and CFD consulting services, software, training and support to a broad range of companies.



## Predictive Engineering – Western States ANSYS LS-DYNA Distributor – Your Free Coffee Cup is On Its Way!

LS-DYNA has been one of Predictive’s core analysis tools pretty much since we got started in 1995. It is an amazing numerical workhorse from the basic linear mechanics (think ANSYS or Nastran) to simulating well nigh the impossible. At least that is the way I feel at times when the model is not solving and spitting out arcane error messages and I’m basically questioning my sanity for accepting this project from hell that has a deadline at the end of the week. Which brings me to my favorite project management image – “trough of despair followed by wiggles of false hope then crash of ineptitude and finally the promised land” but I’ll leave that for another blog.

For now, let’s talk about those free coffee cups. Predictive is now the western states distributor of ANSYS LS-DYNA and provides complete sales, training and services for ANSYS LS-DYNA clients in this region. It is a continuation of our prior setup with LSTC (now ANSYS LST) with the addition of Predictive’s ability to offer ANSYS Workbench with LS-DYNA and other ANSYS software tools. So where’s my free coffee cup? If you are a current Predictive ANSYS LS-DYNA client, we’ll be shipping’em out to you at the end of February and for our new client’s – just send us an email or give us a call.

### [View our portfolio](#) [FEA, CFD and LS-DYNA consulting projects](#)

Composite Engineering

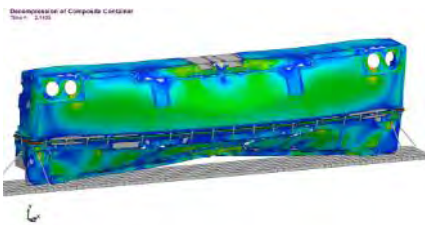

Nonlinear Dynamics

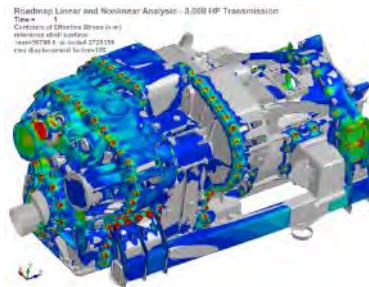

Aerospace

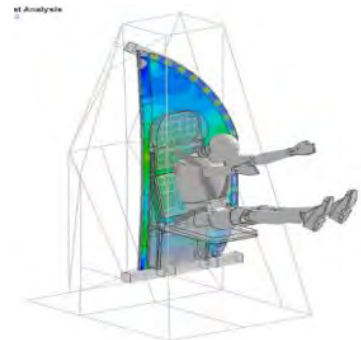

### Contact:

**Address:**  
2512 SE 25th Ave  
Suite 205  
Portland, Oregon 97202  
USA

**Phone:**  
503-206-5571  
**Fax:**  
866-215-1220  
**E-mail:**  
[sales@predictiveengineering.com](mailto:sales@predictiveengineering.com)



Offering industry-leading software platforms and hardware infrastructure for companies to perform scientific and engineering simulations. Providing simulation platforms that empower engineers, scientists, developers, and CIO and IT professionals to design innovative products, develop robust applications, and transform IT into unified, agile environments.



## Modernize your SPDM strategy with Rescale and the Cloud

January 29, 2020 | Fanny Tréheux

Simulation environments face unique challenges: fragmented software and hardware, a large simulation data set, and a complex execution process. Data is isolated and managed using technology 10+ years old. For example, simulation data is managed on the engineering desktop, or at best, through a shared NAS relying heavily on naming conventions. Files are shared with remote users via email or FTP. This hurts simulation expert productivity and the ability to maintain traceability. However, recent advances in cloud technologies have made it possible to modernize Simulation Process & Data Management (SPDM).

### OVERVIEW

Simulation Process & Data Management (SPDM) is a technology trend that has existed since the year 2000, aiming to build a simulation method, provide traceability and increase productivity through automation. “Despite the successes achieved with SPDM, the adoption of information systems to manage simulation data by simulation engineers is still very low at 1%-2%,” according to NAFEMS. Three major legacy inhibitors include: a) lack of openness: commercial solutions are proprietary and lack standards; b) disruption to existing systems: implementing requires major disruptions to the user experience, IT environment, and simulation processes; and c) time to deploy.

### SOLUTION

Because of recent advancements in cloud technology, IT leaders can now rapidly build their own SPDM stack, avoiding vendor lock-in and minimizing disruption to mission-critical applications. A best-of-breed cloud SPDM architecture eliminates manual integration and incorporates cloud-based data stores or data lakes, modern workflow management tools, support for a wide range of commercial applications and license management, and a fully managed stack for automating how these tools integrate. This stack might look like the below:

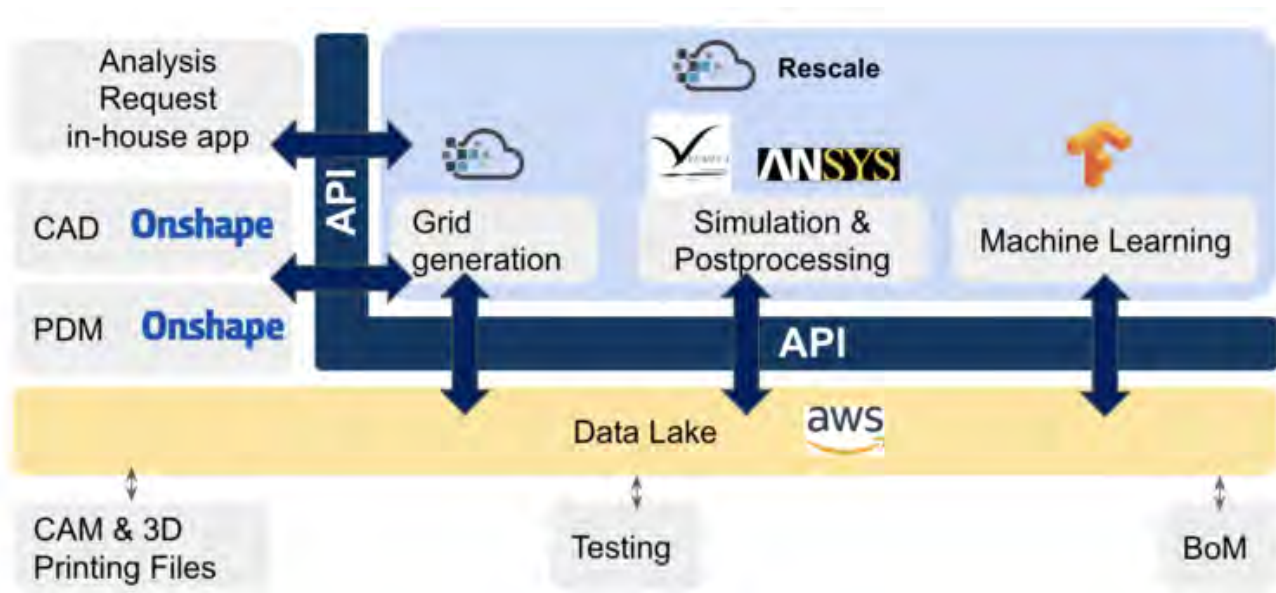

Figure 1 : Example of cloud SPDM solution stack

Rescale offers an integral component to help integrate this best-of-breed stack, and focuses on addressing all the SPDM challenges related to simulation process execution. The ScaleX platform transforms a difficult, complicated and inconvenient HPC experience into something that is easy to maintain, simple to integrate, and intuitive to use. This provides an abstraction layer that automates data movement, process orchestration, and dashboarding across application and execution environments. It lowers barriers to entry for engineers to leverage HPC resources and captures all the precious simulation information without effort from the users.

In this article, we will explore the following technology enablers that make cloud SPDM modernization possible:

- Full-stack simulation workflow formulation
- Automatic HPC data capture
- Globally optimized architecture
- Systematic governance

[Read full article in website](#)

LS-DYNA China, as the master distributor in China authorized by LST, an Ansys company, is fully responsible for the sales, marketing, technical support and engineering consulting services of LS-DYNA in China.



**仿坤软件**  
LS-DYNA China

About Shanghai Fangkun Software Technology Ltd.

Shanghai Fangkun Software Technology Ltd. Is LST, an ANSYS company the domestic master distributor of LS-DYNA software. Shanghai Fangkun is fully responsible for domestic sales, marketing, technical support. By integrating and managing a wide range of resources such as LS-DYNA agents and partners, Shanghai Fangkun is focused on providing strong technical support for domestic LS-DYNA users, and help customers to use LS-DYNA software for product design and development effectively.

#### Contacts:

**Address:** Room 2219, Building No.1, Global Creative Center, Lane 166,  
Minhong Road, Minhang District, Shanghai, China 201102

**Tel.:** 021-61261195 4008533856

**Email:** [sales@lsdyna-china.com](mailto:sales@lsdyna-china.com)  
[support@lsdyna-china.com](mailto:support@lsdyna-china.com)

**Website:** [www.lsdyna-china.com](http://www.lsdyna-china.com)

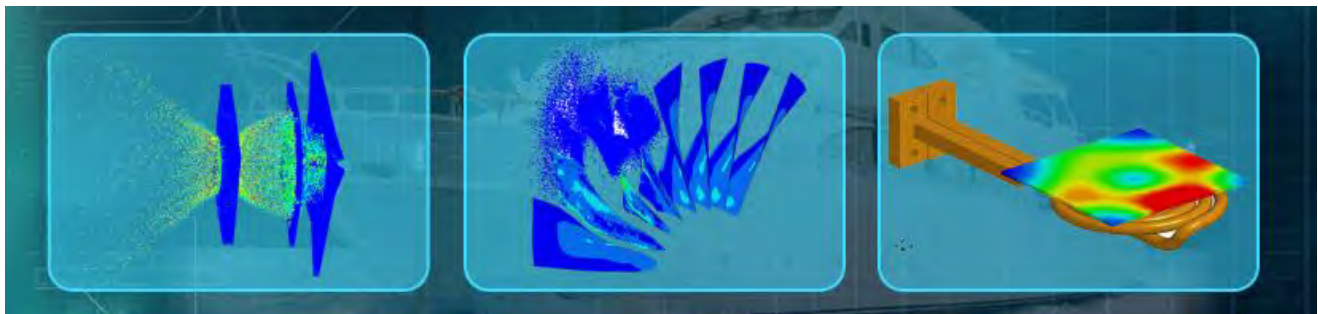
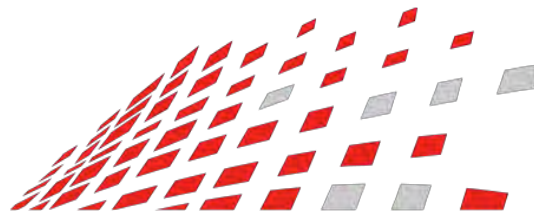

## 2020 Annual Training & Workshop

Dear LS-DYNA users,

To help users to better understand LS-DYNA software and use LS-DYNA more efficiently, Shanghai Fangkun releases 2020 annual training and workshop plan as following tables. We welcome those who are interested to attend.

Date	Topic	City	Duration
20-21, Feb.	Introduction to LS-DYNA (basic training)	Shanghai	2 days
Mar.	Product design with LS-OPT	Shanghai	1 day
Apr.	Crashworthiness in LS-DYNA	Shanghai	2 days
May	Material models in LS-DYNA (composite, non-metal)	Shanghai	2 days
Jun.	Introduction to LS-DYNA (basic training)	Chongqing	2 days
Jun.	Restraint system in LS-DYNA	Shanghai	2 days
Jul.	Battery multi-physics simulation with LS-DYNA	Shanghai	1 day
Sep.	Implicit analysis in LS-DYNA	Shanghai	1 day
Oct.	Fluid structure interaction with LS-DYNA (ALE, ICFD)	Shanghai	2 days
Nov.	Introduction to LS-DYNA (basic training)	Beijing	2 days
Dec.	User-Defined Materials in LS-DYNA	Shanghai	1 day

2020 LS-DYNA online workshop plan			
Date	Topic	Duration	Fee
13rd Jan.	Introduction to MPDB	3 hours	Free
Apr.	Contact Modeling in LS-DYNA	2 hours	Free
May	SALE method in LS-DYNA	2 hours	Free
Jun.	Introduction to Q series dummies	2 hours	Free
Jul.	NVH, Fatigue, & Frequency Domain Analysis in LS-DYNA	2 hours	Free
Aug.	SPG method in LS-DYNA	2 hours	Free
Sep.	Introduction to LS-PrePost	2 hours	Free
Sep.	Introduction to LS-OPT	2 hours	Free
Oct.	Introduction to LS-Form & Stamp forming	2 hours	Free
Oct.	Performance analysis of bus with LS-DYNA	2 hours	Free
Nov.	LST Dummy & Barrier	2 hours	Free
Nov.	EM method in LS-DYNA	2 hours	Free
Dec.	Summary of fluid structure interaction method in LS-DYNA	2 hours	Free
Dec.	Virtual Proving Ground training	2 hours	Free

**Contact: Elva Yu    Tel.: 18221209107, 021-61261195 for more detail information**

**Email: [Training@lsdyna-china.com](mailto:Training@lsdyna-china.com)**

CAE software sale & customer support, initial launch-up support, periodic on-site support. Engineering Services. Timely solutions, rapid problem set up, expert analysis, material property test Tension test, compression test, high-speed tension test and viscoelasticity test for plastic, rubber or foam materials. We verify the material property by LS-DYNA calculations before delivery.



**CAE consulting** - Software selection, CAE software sale & customer support, initial launch-up support, periodic on-site support.

**Engineering Services** - Timely solutions, rapid problem set up, expert analysis - all with our Engineering Services. Terrabyte can provide you with a complete solution to your problem; can provide

you all the tools for you to obtain the solution, or offer any intermediate level of support and software.

## FE analysis

- LS-DYNA is a general-purpose FE program capable of simulating complex real world problems. It is used by the automobile, aerospace, construction, military, manufacturing and bioengineering industries.
- ACS SASSI is a state-of-the-art highly specialized finite element computer code for performing 3D nonlinear soil-structure interaction analyses for shallow, embedded, deeply embedded and buried structures under coherent and incoherent earthquake ground motions.

## CFD analysis

- AMI CFD software calculates aerodynamics, hydrodynamics, propulsion and aero elasticity which covers from concept design stage of aircraft to detailed design, test flight and accident analysis.

## EM analysis

- JMAG is a comprehensive software suite for electromechanical equipment design and development. Powerful simulation and analysis

technologies provide a new standard in performance and quality for product design.

## Metal sheet

- JSTAMP is an integrated forming simulation system for virtual tool shop based on IT environment. JSTAMP is widely used in many companies, mainly automobile companies and suppliers, electronics, and steel/iron companies in Japan.

## Pre/ Post

- **PreSys** is an engineering simulation solution for FE model development. It offers an intuitive user interface with many streamlined functions, allowing fewer operation steps with a minimum amount of data entry.
- **JVISION** - Multipurpose pre/post-processor for FE solver. It has tight interface with LS-DYNA. Users can obtain both load reduction for analysis work and model quality improvements.

## Biomechanics

- **The AnyBody Modeling System™** is a software system for simulating the mechanics of the live human body working in concert with its environment.





## FORD GT SUPERCAR UPGRADED FOR 2020 WITH MORE POWER, NEW SPECIAL EDITION

FEB 6, 2020 | DEARBORN, MICH.

- The Ford GT is improved for 2020 with increased horsepower and upgraded engine cooling
- Titanium exhaust from Akrapovič is now standard for Ford GT; system brings performance exhaust expert's signature craftsmanship with deeply resonant, unmistakable sound
- Two new unique appearance options: Liquid Carbon features GT's carbon fiber body fully exposed; restyled Gulf Racing heritage livery pays homage to Ford's 1969 Le Mans win; plus, supercar's carbon fiber wheels are now available for the first time with heritage livery

**DEARBORN, Mich., Feb. 06, 2020** – Today, Ford Performance announces upgrades to the Ford GT supercar for 2020, including increased engine power to 660 horsepower and improved cooling.

Much of the 2020 Ford GT's advancements are a result of Ford's continuous technological innovation, especially GT's 3.5-liter EcoBoost® twin-turbo V6.

"Ford GT continues to be the pinnacle of Ford performance," said Ed Krenz, Ford Performance chief program engineer. "GT is always the ultimate expression of Ford racing innovation, and as we know from the 1966 Le Mans through today, that means

constantly raising our game for our customers as well as earning the checkered flag."

### Continuous EcoBoost Innovation

Beyond 13 additional horsepower compared to 2017-19 GT supercars, the 2020 GT's EcoBoost engine features a broader torque band and revised engine calibration plus mechanical upgrades that include gallery-cooled pistons and higher-energy ignition coils, thanks to lessons learned from the limited-edition, track-only GT Mk II.

Additional engine cooling and airflow updates includes new buttress air ducts designed to increase air flow by 50 percent while larger intercoolers keep charge air temperatures cooler, preserving peak power for the most strenuous, high-temperature sessions at the track. Suspension damping is increased in track mode to further enhance handling and body control, particularly for those high-speed transient sections of closed-course circuits.

### New Standard Akrapovič titanium exhaust

Ford Performance is also introducing the premium Akrapovič titanium exhaust as standard equipment for GT. Boasting the signature craftsmanship of these renowned race experts, this exhaust provides a nine-pound weight savings over the previous system while featuring that deeply resonant, unmistakable sound emanating from the more powerful EcoBoost engine.

## Liquid Carbon

Newly available Ford GT Liquid Carbon places an emphasis on GT's lightweight sculpted carbon fiber body completely free of paint color. A special clearcoat punctuates each GT's unique carbon fiber weave in this limited-edition appearance option.

“This next chapter in the Ford GT story allows us to fully demonstrate our mastery in both the art and science of carbon fiber craftsmanship and finishing,” said Angus Smith, General Manager of Multimatic Niche Vehicles, North America. “The results of this ongoing partnership between Multimatic and Ford Performance speak for themselves, as each visually stunning and unique Liquid Carbon GT is a manufacturing marvel, showcasing the characteristics and nuances inherent in carbon fiber composites.”

Ford GT Liquid Carbon features carbon fiber wheels as standard equipment. Owners can choose titanium lugnuts, six-point racing harness anchors, five interior options and five caliper colors. Further personalization is available through two over-the-top stripe options – the dual center stripes offered on the standard Ford GT or the single stripe found on the Carbon Series as well as optional painted mirror caps. Stripes and mirror caps are available in any of the seven standard paint colors as well as the extended color palette. For the first time, these features can be ordered independently of one another.

## Updated Gulf Racing Heritage Livery

Ford Performance is also updating GT's iconic heritage livery with a new design that includes a black pinstripe to divide the distinct blue and orange colors, recalling the 1968-69 Le Mans-winning GT40. The optional carbon fiber number switches from 9 on the 2019 model to 6 for 2020, matching that of the historic back-to-back winning car, chassis No. 1075. For the first time on a heritage model, carbon fiber wheels are available in lieu of aluminum alloy.

“Our team is very focused on delivering a car that exceeds customer expectations,” said Mike Severson, Ford GT program manager. “The black pinstripe and carbon fiber wheels have been highly requested with the Gulf livery, so we committed to making that happen.”

Deliveries of the upgraded 2020 Ford GT are ongoing, with production wrapping up in 2022.

## About Ford Motor Company

Ford Motor Company is a global company based in Dearborn, Michigan. The company designs, manufactures, markets and services a full line of Ford cars, trucks, SUVs, electrified vehicles and Lincoln luxury vehicles, provides financial services through Ford Motor Credit Company and is pursuing leadership positions in electrification, autonomous vehicles and mobility solutions. Ford employs approximately 191,000 people worldwide. For more information regarding Ford, its products and Ford Motor Credit Company, please visit [corporate.ford.com](https://corporate.ford.com).

# *LS-DYNA - Resource Links*

---

**LS-DYNA Multiphysics      YouTube**

<https://www.youtube.com/user/980LsDyna>

**FAQ      LSTC**

<ftp.lstc.com/outgoing/support/FAQ>

**LS-DYNA Support Site**

[www.dynasupport.com](http://www.dynasupport.com)

**LS-OPT & LS-TaSC**

[www.lsoptsupport.com](http://www.lsoptsupport.com)

**LS-DYNA EXAMPLES**

[www.dynaexamples.com](http://www.dynaexamples.com)

**LS-DYNA CONFERENCE PUBLICATIONS**

[www.dynalook.com](http://www.dynalook.com)

**ATD –DUMMY MODELS**

[www.dummymodels.com](http://www.dummymodels.com)

**LSTC ATD MODELS**

[www.lstc.com/models](http://www.lstc.com/models)      [www.lstc.com/products/models/maillinglist](http://www.lstc.com/products/models/maillinglist)

**AEROSPACE WORKING GROUP**

<http://awg.lstc.com>



# Training - Webinars



## Participant's Training Classes

**Webinars**

**Info Days**

**Class Directory**

## Directory

<b>BETA CAE Systems</b>	<a href="http://www.beta-cae.com/training.htm">www.beta-cae.com/training.htm</a>
<b>DYNAmore</b>	<a href="http://www.dynamore.de/en/training/seminars">www.dynamore.de/en/training/seminars</a>
<b>Dynardo</b>	<a href="http://www.dynardo.de/en/wost.html">http://www.dynardo.de/en/wost.html</a>
<b>ESI-Group</b>	<a href="https://myesi.esi-group.com/trainings/schedules">https://myesi.esi-group.com/trainings/schedules</a>
<b>ETA</b>	<a href="http://www.eta.com/training">http://www.eta.com/training</a>
<b>KOSTECH</b>	<a href="http://www.kostech.co.kr">www.kostech.co.kr</a>
<b>ANSYS LST</b>	<a href="http://www.lstc.com/training">www.lstc.com/training</a>
<b>LS-DYNA OnLine - (Al Tabiei)</b>	<a href="http://www.LSDYNA-ONLINE.COM">www.LSDYNA-ONLINE.COM</a>
<b>OASYS</b>	<a href="http://www.oasys-software.com/training-courses">www.oasys-software.com/training-courses</a>
<b>Predictive Engineering</b>	<a href="http://www.predictiveengineering.com/support-and-training/ls-dyna-training">www.predictiveengineering.com/support-and-training/ls-dyna-training</a>

# Training - Dynamore

Author: Christian Frech [christian.frech@dynamore.de](mailto:christian.frech@dynamore.de)



## Seminars 2020

Visit the website for complete overview and registration [www.dynamore.de/seminars](http://www.dynamore.de/seminars)



### Selection of trainings for March/April

#### *Introduction*

Introduction to LS-DYNA

24-26 March  
31 March -2 April (Z)  
1-2 April (T)  
3 April (T)  
27 April (Z)

Nonlinear Implicit Analyses

#### *Crash*

Crash Analysis

17-20 March  
24-27 March (G)  
9-10 March  
21-22 March (G)  
16 March  
30 March (V)

Joining Techniques in LS-DYNA

Failure of Fiber-Reinforced Polymers

Introduction to contact definitions in LS-DYNA

#### *Passive Safety*

Introduction to Passive Safety

CMP Airbag Modeling

12-13 March  
27 March

#### *Material*

Material Failure

Polymers/Elastomers

Simulation of continuous fiber reinforced composites

Simulation of short fiber reinforced composites

Modeling Metallic Materials

23-24 March (T)  
20-21 April  
22-23 April  
24 April  
23-24 April (T)

#### *Implicit Capabilities*

Implicit Analysis using LS-DYNA

11-12 March

### **Information days (free of charge)**

New Features in LS-DYNA

18 March (T)

Optimization with ANSA, LS-OPT and META

23 March

**We hope that our offer will meet your needs and are looking forward to welcoming you at one of the events.**

If not otherwise stated, the event location is Stuttgart, Germany. Other event locations are:

A = Aachen, Germany, Ba = Bamberg, Germany, G = Gothenburg, Sweden; L = Linköping, Sweden,

V = Versailles, France; T = Turin, Italy, Tr = Trafoch, Austria, Z = Zurich, Switzerland

# Training – LST, an ANSYS company

[www.lstc.com](http://www.lstc.com)

## March 2020

<i>Date</i>		<i>Location</i>	<i>Course Title</i>	<i>Instructor(s)</i>
Mar 2	Mar 4	<b>CA</b>	ALE, Eulerian, & Fluid-Structure Interaction in LS-DYNA®	M. Souli
Mar 5	Mar 6	<b>CA</b>	Smoothed Partical Hydrodynamics (SPH) in LS-DYNA®	M. Souli
Mar 10	Mar 13	<b>MI</b>	Introduction to LS-DYNA®	R. Chivukula
Mar 16		<b>CA</b>	Verification & Validation in LS-DYNA®	A. Tabiei
Mar 16	Mar 17	<b>MI</b>	Airbag Modeling in LS-DYNA®	A. Nair
Mar 17	Mar 20	<b>CA</b>	Introduction to LS-DYNA®	A. Tabiei

## April 2020

<i>Date</i>		<i>Location</i>	<i>Course Title</i>	<i>Instructor(s)</i>
Apr 1		<b>CA</b>	Introduction to LS-TaSC™	I. Gandikota
Apr 2	Apr 3	<b>CA</b>	Introduction to LS-OPT®	I. Gandikota
Apr 14	Apr 15	<b>CA</b>	Concrete & Geomaterial Modeling with LS-DYNA®	L. Schwer
Apr 15		<b>MI</b>	Airbag Particle Method (APM)	A. Gromer
Apr 20	Apr 21	<b>CA</b>	Advanced LS-PrePost®	A. Nair
Apr 22	Apr 23	<b>CA</b>	Advanced LS-DYNA®	S. Bala
Apr 28	Apr 29	<b>MI</b>	Contact Modeling in LS-DYNA®	N. Karajan

## Recent Developments in Time Domain Fatigue Analysis with LS-DYNA®

Zhe Cui, Yun Huang

Livermore Software Technology, an ANSYS Company

**Abstract:** A series of new options were implemented to the time domain fatigue analysis features since the last China LS-DYNA User's Conference in Shanghai, 2017. They include:

- Fatigue mean stress correction methods
- Load steps definition
- Fatigue damage evolution
- Fatigue failure simulation
- Multiaxial fatigue analysis
- Fatigue summation

This paper gives a brief review of these new options for time domain fatigue analysis with LS-DYNA. Some examples are provided to demonstrate the new feature of LS-DYNA, and show how to use this feature towards different loading cases.

**Keywords:** LS-DYNA, time domain, fatigue analysis

### 1 Fatigue mean stress correction methods

Mean stress has important effect on fatigue behavior of metal structures. Mean stress correction is necessary for accurate prediction of fatigue life of those metal structures. Under different mean stress, the SN curve of the same material can change quite a lot.

In LS-DYNA, two categories of mean stress correction methods are available.

Use equations to perform mean stress correction, based on the SN curves obtained by fully reversed testing ( $R = -1$ , or mean stress = 0). Following mean stress correction equations are available

- Goodman equation
- Soderberg equation
- Gerber equation
- Goodman tension only equation
- Gerber tension only equation
- Morrow equation (for fatigue analysis based on EN curve)
- Smith-Watson-Topper equation (for fatigue analysis based on EN curve)

Use `*DEFINE_TABLE` to define a family of SN curves. Each curve corresponds to a unique mean stress. In `*MAT_ADD_FATIGUE` keyword, use the table ID for the SN curve. When a mean stress is not represented by the existing SN curves, interpolation is performed to find the corresponding number of cycles for failure  $N$ , for the given stress range or stress amplitude  $S$ , under current mean stress.

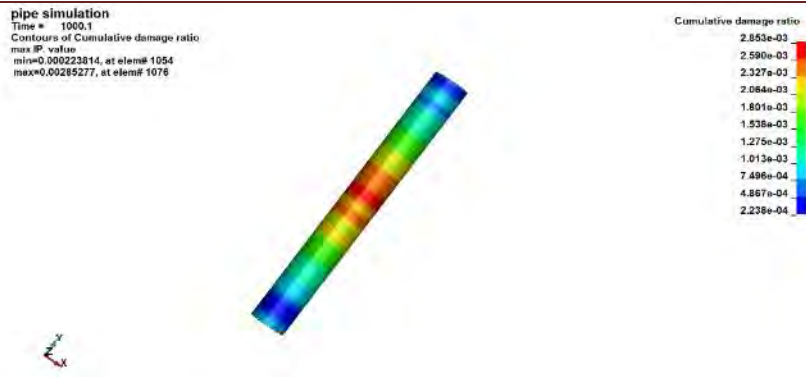

Figure1. Damage ratio without mean stress correction

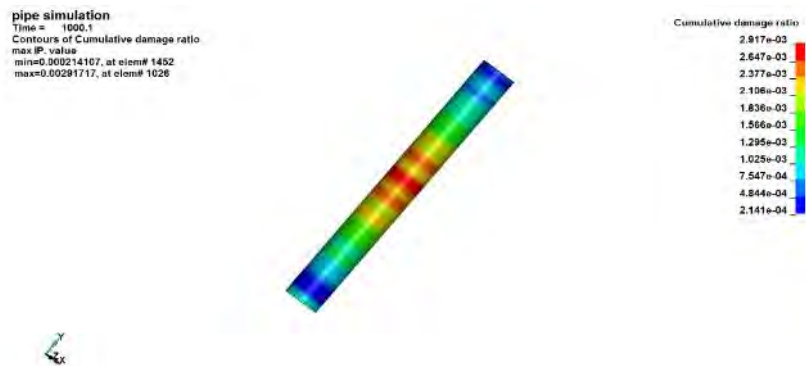

Figure2. Damage ratio with mean stress correction

Figure1 and 2 show a pipe model cumulative damage ratio comparison with and without mean stress correction. One can see that the original damage ratio is 0.002853 and the damage ratio is 0.002917 with mean stress correction.

## 2 Load steps definition

A new keyword **\*FATIGUE\_LOADSTEP** was implemented to define load steps in fatigue analysis.

One can choose which segments of loading history are needed in fatigue analysis. Sometimes user may want to skip the starting transient response in fatigue analysis, and use only the steady state cyclic response.

One can compute fatigue cumulative damage ratio for a long term load, based on representation on a shorter load step. The cumulative damage ratio, computed on the shorter load step, is multiplied by a scale factor (which is the ratio between the duration of real load and the duration of the representative load step), to provide estimation of the cumulative damage ratio for the real load, which could be much longer and be prohibitive to compute otherwise. Of course, it is assumed that stress / strain response in the shorter load step is a good representation of the behavior in the real load step. And the material properties don't change with the number of load cycles, or with the load sequence. In other words, the fatigue behavior of the structure is linear.

# LS-DYNA New Feature and Application

The example pipe is modelled by \*MAT\_ELASTIC\_PLASTIC\_THERMAL. The thermal loading is defined by \*LOAD\_THERMAL\_LOAD\_CURVE. The keyword cards for \*FATIGUE\_LOADSTEP and other keywords for the load can be found in Figure 3. The thermal loading time history is in Figure 4.

```

*FATIGUE_ELOUT
$#  ssid  sstype
$#
$#  dt
$#
$#  stres  index  restrt  texpos
$#  0      0
*DATABASE_D3FTG
$#  binary
$#  1
*FATIGUE_LOADSTEP
$#  tstart  tend  texpos
$#  0.0     50.  10000.
$#  50.0    100. 20000.
*DEFINE_CURVE
$#  lcid  sidr  sfa  sfo
$#  888   0    1.0  1.0
$#
$#  al  ol
$#  0.0  0.0
$#  5.0  200.0
$#  10.0  0.0
$#  15.0  200.0
$#  20.0  0.0
$#  25.0  200.0
$#  30.0  0.0
$#  35.0  200.0
$#  40.0  0.0
$#  45.0  200.0
$#  50.0  0.0
$#  55.0  400.0
$#  60.0  0.0
$#  65.0  400.0
$#  70.0  0.0
$#  75.0  400.0
$#  80.0  0.0
$#  85.0  400.0
$#  90.0  0.0
$#  95.0  400.0
$#  100.0 0.0
    
```

Figure3. Keyword setting for running fatigue time step

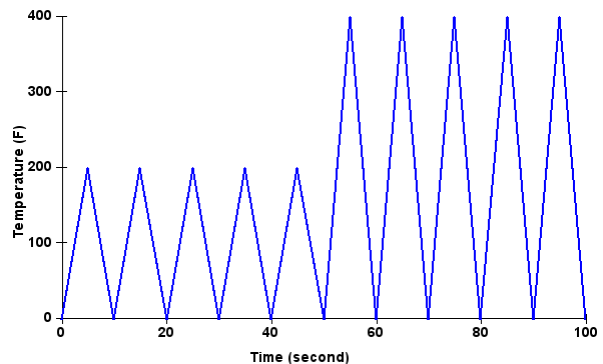

Figure4. Thermal loading time history

The pipe is subjected to two steps of cyclic thermal loading. For the first load step, the temperature varies between 0°F and 200°F and this lasts for 10000 seconds. For the second load step, the temperature varies between 0°F and 400°F and this lasts for 20000 seconds. It is very time consuming to run finite element simulation for the whole thermal loading history of 30000 seconds. To get a quick estimation of the cumulative damage ratio, we can reduce the duration for each load step to only 50 seconds, and multiply the cumulative damage ratio generated in each step by a scale factor which is the ratio between the real loading period and the reduced loading period.

Figure 5 shows the distribution of effective stress near the end of simulation. Figure 6 shows the cumulative damage ratio of the pipe, after the 30000 seconds thermal loading. One can see that the maximum values of the effective stress and the cumulative damage ratio appear near the bottom of the pipe, probably due to the stress concentration at the constraints.

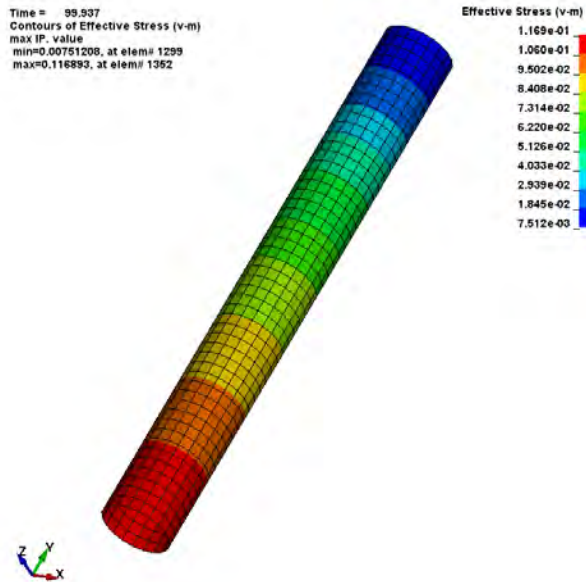

Figure5. Effective stress at the end of simulation

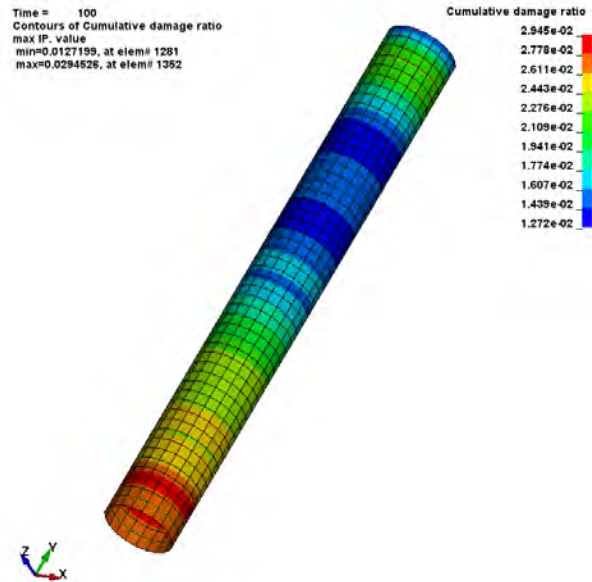

Figure6. Cumulative damage ratio

## 3 Fatigue damage evolution and fatigue failure simulation

To show fatigue damage evolution, a progressive fatigue analysis is needed. The corresponding keywords are **\*DATABASE\_D3FTG** and **\*FATIGUE\_FAILURE**.

### 3.1 Fatigue damage evolution

With a nonzero **DT** in **\*DATABASE\_D3FTG**, LS-DYNA can perform fatigue analysis and dump out d3ftg database every **DT** time. Multiple states are saved in d3ftg and can be plotted using LS-PrePost 4.7 or newer versions. Each state saves cumulative damage ratios for the whole structure at one time point. With this database, user can track the fatigue damage ratio evolution for the structure.

Figure7 shows an L-beam fixed to a bottom plate by four bolts. The plate is constrained to ground. Prescribed harmonic motion (displacement) is applied on the edge of the hole on the L-beam, in the vertical direction. The prescribed displacement time history is shown in Figure8.

The cumulative damage ratio fringe plots at time 0.01s, 0.02s and 0.03s are shown in Figure9. Constant color scale from 0 to 1.0 is used for all the plots so that one can easily compare the magnitude of the cumulative damage ratio, and trace the development of the damage. It is clear that the area at the lower edge of the hole experiences higher fatigue damage. The damage ratio increases with time and the damage area expands with time.

# LS-DYNA New Feature and Application

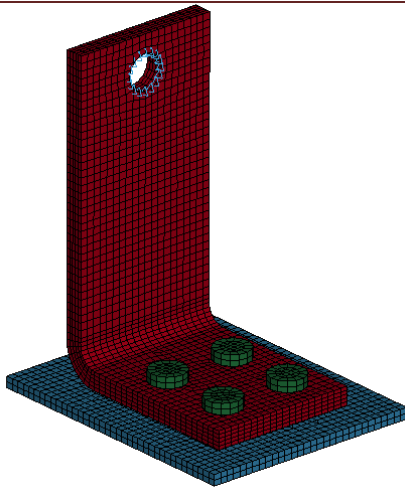

Figure7. A L-BEAM constrained to a bottom plate

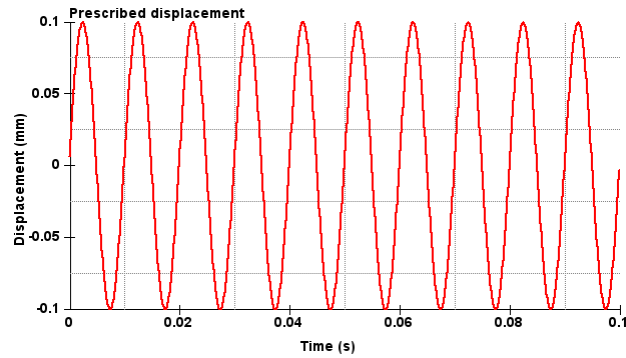

Figure8. Prescribed harmonic displacement on the hole

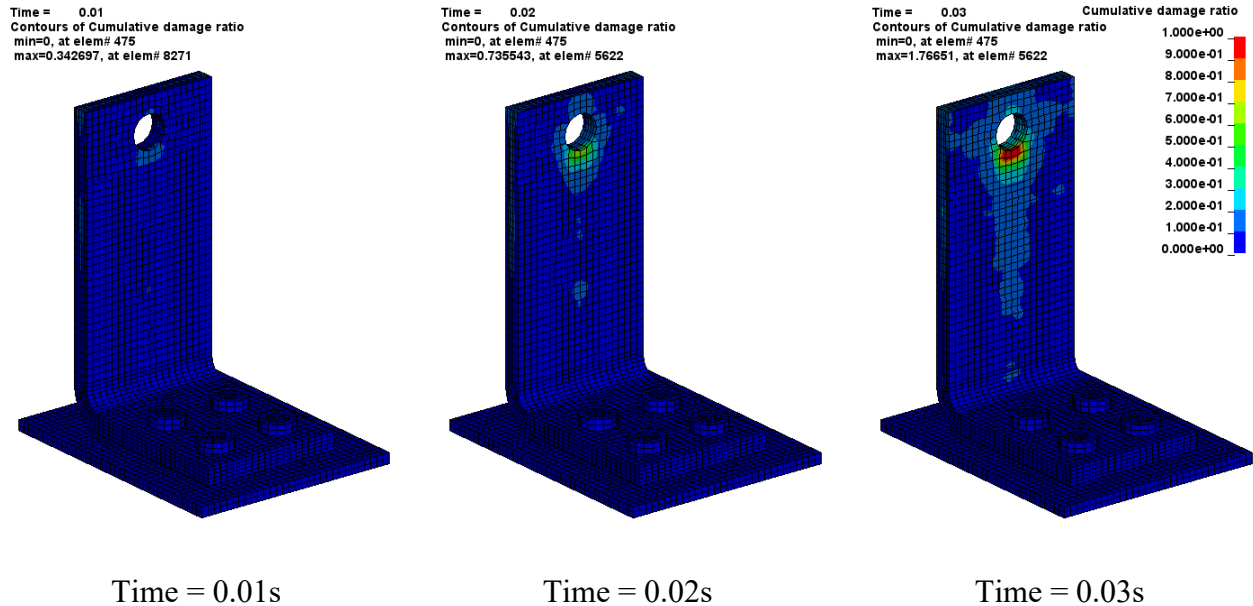

Figure9. Cumulative damage ratio at different time points

## 3.2 Fatigue failure simulation

A new keyword **\*FATIGUE\_FAILURE** was implemented to introduce a mechanism to model the failure of elements due to fatigue. With this keyword, user can define a threshold cumulative damage ratio (the default value is 1.0) and all the elements with cumulative damage ratio larger or equal to this value can be removed from the structure for subsequent simulation. For increased safety factor, the threshold cumulative damage ratio can be defined as a number smaller than 1.0.

This is a simple way to show the local failure of structures due to fatigue, and it provides an opportunity to study the effect of local fatigue failure on the overall behavior of structures in a long term. An approximate fatigue crack propagation trajectory can be obtained by this approach.



# LS-DYNA New Feature and Application

A more accurate simulation of the fatigue crack propagation can be achieved by using the approach by fracture mechanics, or using the cohesive zone modelling.

The max cumulative damage ratio at time 0.03 second is 1.76651 (see Figure9). It is obvious that several elements have failed (including element 5622, which exhibits the max cumulative damage ratio 1.76651). With **\*FATIGUE\_FAILURE** and **IFAILURE= 1** and **DRATIO=1.0**, LS-DYNA automatically removes those elements whose cumulative damage ratio  $\geq 1.0$  from the structure. The remaining elements and their cumulative damage ratio fringe plot are shown in Figure10. Then the cumulative damage ratio of the remaining elements continues to grow with the loading. Figure11 shows the cumulative damage ratio at 0.04 second. One can see that the cumulative damage ratio of several other elements goes beyond 1.0 at 0.04 second (e.g. element 5587), and this results in failure of those elements too. Those failed elements are removed too, as shown in Figure 12. It is expected that with the loading cycles going on, more and more elements will have cumulative damage ratio  $\geq 1.0$  and will fail and be removed from the structure. Figure13 shows the keyword setting for modelling fatigue damage evolution and fatigue failure.

Time = 0.03  
Contours of Cumulative damage ratio  
min=0, at elem# 475  
max=0.724296, at elem# 5587

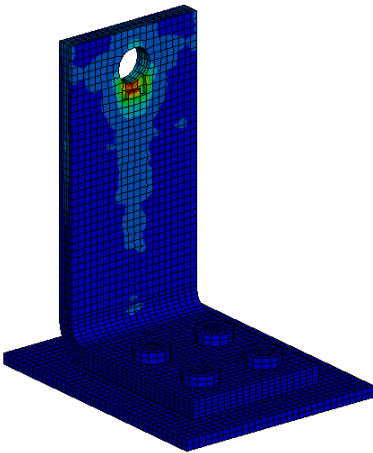

Figure10. Cumulative damage ratio at 0.03s (failed elements are removed)

Time = 0.04  
Contours of Cumulative damage ratio  
min=0, at elem# 475  
max=1.22308, at elem# 5587

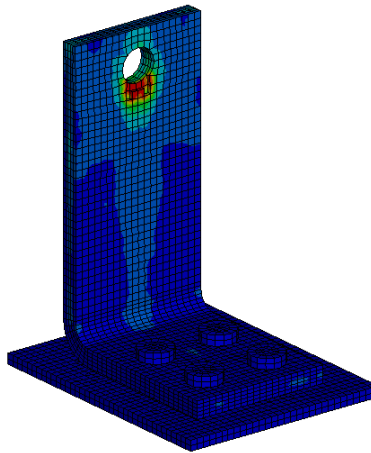

Figure11. Cumulative damage ratio at 0.04s (failed elements are removed)

Time = 0.04  
Contours of Cumulative damage ratio  
min=0, at elem# 475  
max=0.703995, at elem# 8271

Cumulative damage ratio  
1.000e+00  
9.000e-01  
8.000e-01  
7.000e-01  
6.000e-01  
5.000e-01  
4.000e-01  
3.000e-01  
2.000e-01  
1.000e-01  
0.000e+00

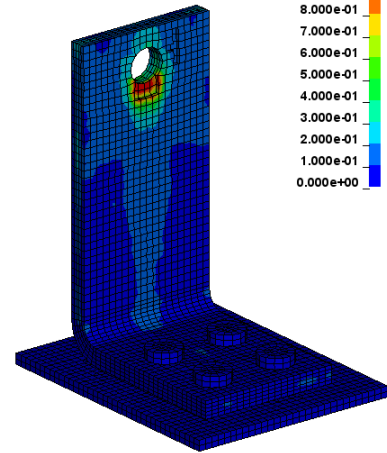

Figure12. Cumulative damage ratio at 0.04s (failed elements are removed)

```
*FATIGUE_ELOUT
$# pid ptype
$# dt
$# strsn index restrt texpos
$
*DATABASE_D3FTG
$# binary dt
1 1.E-02
*FATIGUE_FAILURE
$#ifailure dratio
1 1.
*DATABASE_ELOUT
1.E-05 2
```

Figure13. Keyword setting for modelling fatigue damage evolution and fatigue failure.



## 5 Fatigue summation

This keyword reads in existing fatigue databases defined by

\*INITIAL\_FATIGUE\_DAMAGE\_RATIO and sum up the damage ratio results from them to obtain the final cumulative damage ratio. The final cumulative damage ratio results are dumped to a new d3fmg database. The Figure17 and 18 show a comparison of a simple plate cumulative damage ratio with and without damage from transient preload. One can see that the damage ratio is 0.3440 from fatigue load and the damage ratio is 0.3443 from fatigue load plus transient preload.

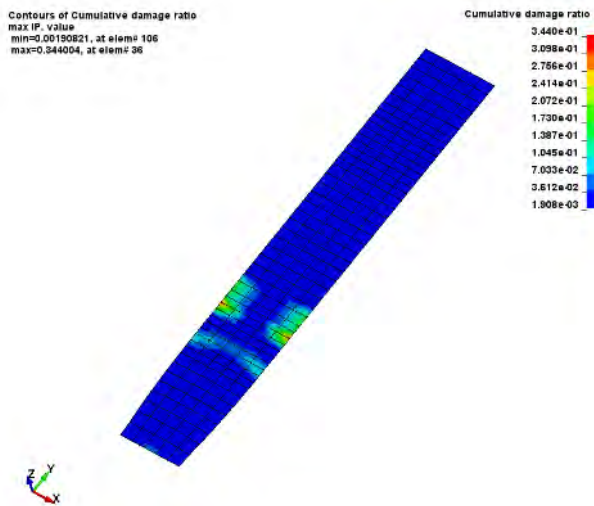

Figure17. Damage ratio from fatigue load

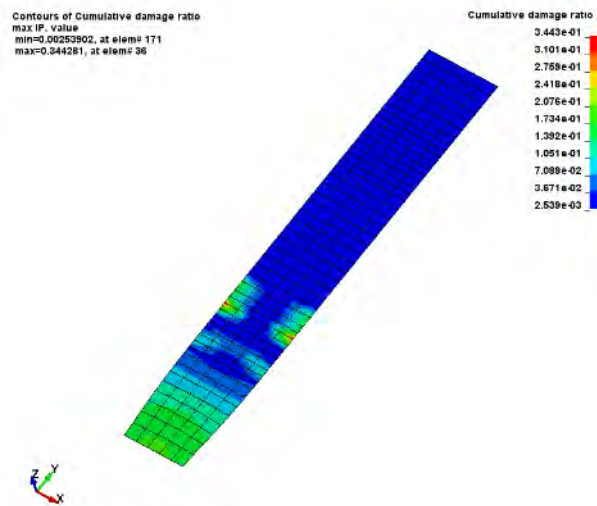

Figure17. Cumulative damage ratio from transient preload + fatigue load

## 6 Summary

This paper reviews recent updates in time domain fatigue analysis in LS-DYNA, and introduces several new keywords and options for running these features. These new options and enhancements enable users to solve more comprehensive problems in NVH and durability analysis.



**BETA CAE Systems.**

[www.beta-cae.com](http://www.beta-cae.com)

## **BETA CAE Systems - ANSA**

An advanced multidisciplinary CAE pre-processing tool that provides all the necessary functionality for full-model build up, from CAD data to ready-to-run solver input file, in a single integrated environment. ANSA is a full product modeler for LS-DYNA, with integrated Data Management and Process Automation. ANSA can also be directly coupled with LS-OPT or LST, an ANSYS company to provide an integrated solution in the field of optimization.

## **BETA CAE Systems $\mu$ ETA**

Is a multi-purpose post-processor meeting diverging needs from various CAE disciplines. It owes its success to its impressive performance, innovative features and capabilities of interaction between animations, plots, videos, reports and other objects. It offers extensive support and handling of LS-DYNA 2D and 3D results, including those compressed with SCAI's FEMZIP software.

## **Solutions for:**

Process Automation - Data Management – Meshing – Durability - Crash & Safety NVH - CFD  
- Thermal analysis - Optimization - Powertrain  
Products made of composite materials - Analysis Tools -  
Maritime and Offshore Design - Aerospace engineering - Biomechanics



ETA – Engineering Technology Associates  
[etainfo@eta.com](mailto:etainfo@eta.com)

[www.eta.com](http://www.eta.com)

## **Invention Suite™**

Invention Suite™ is an enterprise-level CAE software solution, enabling concept to product. Invention's first set of tools will be released soon, in the form of an advanced Pre & Post processor, called PreSys.

Invention's unified and streamlined product architecture will provide users access to all of the suite's software tools. By design, its products will offer a high performance modeling and post-processing system, while providing a robust path for the integration of new tools and third party applications.

## **PreSys**

Invention's core FE modeling toolset. It is the successor to ETA's VPG/PrePost and FEMB products. PreSys offers an easy to use interface, with drop-down

menus and toolbars, increased graphics speed and detailed graphics capabilities. These types of capabilities are combined with powerful, robust and accurate modeling functions.

## **VPG**

Advanced systems analysis package. VPG delivers a unique set of tools which allow engineers to create and visualize, through its modules--structure, safety, drop test, and blast analyses.

## **DYNAFORM**

Complete Die System Simulation Solution. The most accurate die analysis solution available today. Its formability simulation creates a "virtual tryout", predicting forming problems such as cracking, wrinkling, thinning and spring-back before any physical tooling is produced.



ESI Group

**get it right®** **Visual-Environment** is an integrative simulation platform for simulation tools operating either concurrently or standalone for various solver. Comprehensive and integrated solutions for meshing, pre/post processing, process automation and simulation data management are available within same environment enabling seamless execution and automation of tedious workflows. This very open and versatile environment simplifies the work of CAE engineers across the enterprise by facilitating collaboration and data sharing leading to increase of productivity.

**Visual-Crash DYNA** provides advanced preprocessing functionality for LS-DYNA users, e.g. fast iteration and rapid model revision processes, from data input to visualization for crashworthiness simulation and design. It ensures quick model browsing, advanced mesh editing capabilities and rapid graphical assembly of system models. **Visual-Crash DYNA** allows graphical creation, modification and deletion of LS-DYNA entities. It comprises tools for checking model quality and simulation parameters prior to launching calculations with the solver. These tools help in correcting errors and fine-tuning the model and simulation before submitting it to the solver, thus saving time and resources.

Several high productivity tools such as advanced dummy positioning, seat morphing, belt fitting and airbag folder are provided in **Visual-Safe**, a dedicated application to safety utilities.

**Visual-Mesh** is a complete meshing tool supporting CAD import, 1D/2D/3D meshing and editing for linear and quadratic meshes. It supports all meshing capabilities, like shell and solid automesh, batch meshing, topo mesh, layer mesh, etc. A convenient Meshing Process guides

[www.esi-group.com](http://www.esi-group.com)

you to mesh the given CAD component or full vehicle automatically.

**Visual-Viewer** built on a multi-page/multi-plot environment, enables data grouping into pages and plots. The application allows creation of any number of pages with up to 16 windows on a single page. These windows can be plot, animation, video, model or drawing block windows. **Visual-Viewer** performs automated tasks and generates customized reports and thereby increasing engineers' productivity.

**Visual-Process** provides a whole suite of generic templates based on LS-DYNA solver (et altera). It enables seamless and interactive process automation through customizable LS-DYNA based templates for automated CAE workflows.

All generic process templates are easily accessible within the unique framework of **Visual-Environment** and can be customized upon request and based on customer's needs.

**VisualDSS** is a framework for Simulation Data and Process Management which connects with **Visual-Environment** and supports product engineering teams, irrespective of their geographic location, to make correct and realistic decisions throughout the virtual prototyping phase. **VisualDSS** supports seamless connection with various CAD/PLM systems to extract the data required for building virtual tests as well as building and chaining several virtual tests upstream and downstream to achieve an integrated process. It enables the capture, storage and reuse of enterprise knowledge and best practices, as well as the automation of repetitive and cumbersome tasks in a virtual prototyping process, the propagation of engineering changes or design changes from one domain to another.



## JSOL Corporation

[www.jsol.co.jp/english/cae/](http://www.jsol.co.jp/english/cae/)

### HYCRASH

Easy-to-use one step solver, for Stamping-Crash Coupled Analysis. HYCRASH only requires the panels' geometry to calculate manufacturing process effect, geometry of die are not necessary. Additionally, as this is target to usage of crash/strength analysis, even forming analysis data is not needed. If only crash/strength analysis data exists and panel ids is defined. HYCRASH extract panels to calculate it's strain, thickness, and map them to the original data.

### JSTAMP/NV

As an integrated press forming simulation system for virtual tool shop

the JSTAMP/NV meets the various industrial needs from the areas of automobile, electronics, iron and steel, etc. The JSTAMP/NV gives satisfaction to engineers, reliability to products, and robustness to tool shop via the advanced technology of the JSOL Corporation.

### JMAG

JMAG uses the latest techniques to accurately model complex geometries, material properties, and thermal and structural phenomena associated with electromagnetic fields. With its excellent analysis capabilities, JMAG assists your manufacturing process.



Livermore Software Technology, an ANSYS Company

[www.lstc.com](http://www.lstc.com)

## LS-DYNA

A general-purpose finite element program capable of simulating complex real world problems. It is used by the automobile, aerospace, construction, military, manufacturing, and bioengineering industries. LS-DYNA is optimized for shared and distributed memory Unix, Linux, and Windows based, platforms, and it is fully QA'd by LST, an ANSYS company. The code's origins lie in highly nonlinear, transient dynamic finite element analysis using explicit time integration.

## LS-PrePost

An advanced pre and post-processor that is delivered free with LS-DYNA. The user interface is designed to be both efficient and intuitive. LS-PrePost runs on Windows, Linux, and Macs utilizing OpenGL graphics to achieve fast rendering and XY plotting.

## LS-OPT

LS-OPT is a standalone Design Optimization and Probabilistic Analysis package with an interface to LS-DYNA. The graphical preprocessor LS-OPTui facilitates definition of the design input and the creation of a command

file while the postprocessor provides output such as approximation accuracy, optimization convergence, tradeoff curves, anthill plots and the relative importance of design variables.

## LS-TaSC

A Topology and Shape Computation tool. Developed for engineering analysts who need to optimize structures, LS-TaSC works with both the implicit and explicit solvers of LS-DYNA. LS-TaSC handles topology optimization of large non-linear problems, involving dynamic loads and contact conditions.

## LST, AN ANSYS COMPANY Dummy Models

Anthropomorphic Test Devices (ATDs), as known as "crash test dummies", are life-size mannequins equipped with sensors that measure forces, moments, displacements, and accelerations.

## LST, AN ANSYS COMPANY Barrier Models

LSTC offers several Offset Deformable Barrier (ODB) and Movable Deformable Barrier (MDB) model.



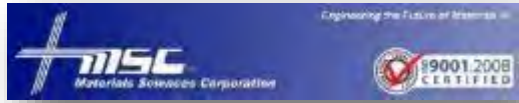

## Material Sciences Corporation

[www.materials-sciences.com](http://www.materials-sciences.com)

Materials Sciences Corporation has provided engineering services to the composites industry since 1970. During this time, we have participated in numerous programs that demonstrate our ability to: perform advanced composite design, analysis and testing; provide overall program management; work in a team environment; and transition new product development to the military and commercial sectors. MSC's corporate mission has expanded beyond basic research and development now to include transitioning its proprietary technologies from the research lab into innovative new products. This commitment is demonstrated through increased staffing and a more than 3-fold expansion of facilities to allow in-house manufacturing and testing of advanced composite materials and structures.

Materials Sciences Corporation (MSC) MAT161/162 - enhanced features have been added to the Dynamic Composite Simulator module of LS-DYNA.

This enhancement to LS-DYNA, known as MAT161/162, enables the most effective and accurate dynamic progressive failure modeling of composite structures to enable the most effective and accurate dynamic progressive

failure modeling of composite structures currently available.

## MSC/LS-DYNA Composite Software and Database -

**Fact Sheet:** <http://www.materials-sciences.com/dyna-factsheet.pdf>

- MSC and LSTC have joined forces in developing this powerful composite dynamic analysis code.
- For the first time, users will have the enhanced ability to simulate explicit dynamic engineering problems for composite structures.
- The integration of this module, known as 'MAT 161', into LS-DYNA allows users to account for progressive damage of various fiber, matrix and interply delamination failure modes.
- Implementing this code will result in the ability to optimize the design of composite structures, with significantly improved survivability under various blast and ballistic threats.

MSC's LS-DYNA module can be used to characterize a variety of composite structures in numerous applications—such as this composite hull under blast.



LS-DYNA ENVIRONMENT

## Oasys Ltd. LS-DYNA Environment

[www.oasys-software.com/dyna](http://www.oasys-software.com/dyna)

The Oasys Suite of software is exclusively written for LS-DYNA® and is used worldwide by many of the largest LS-DYNA® customers. The suite comprises of:

### Oasys PRIMER

Key benefits:

- Pre-Processor created specifically for LS-DYNA®
- Compatible with the latest version of LS-DYNA®
- Maintains the integrity of data
- Over 6000 checks and warnings – many auto-fixable
- Specialist tools for occupant positioning, seatbelt fitting and seat squashing (including setting up pre-simulations)
- Many features for model modification, such as part replace
- Ability to position and de-penetrate impactors at multiple locations and produce many input decks automatically (e.g. pedestrian impact, interior head impact)

- Contact penetration checking and fixing
- Connection feature for creation and management of connection entities.
- Support for Volume III keywords and large format/long labels
- Powerful scripting capabilities allowing the user to create custom features and processes

[www.oasys-software.com/dyna](http://www.oasys-software.com/dyna)

### Oasys D3PLOT

Key benefits:

- Powerful 3D visualization post-processor created specifically for LS-DYNA®
- Fast, high quality graphics
- Easy, in-depth access to LS-DYNA® results
- Scripting capabilities allowing the user to speed up post-processing, as well as creating user defined data components



[www.predictiveengineering.com](http://www.predictiveengineering.com)

Predictive Engineering provides finite element analysis consulting services, software, training and support to a broad range of engineering companies across North America. We strive to exceed client expectations for accuracy, timeliness and knowledge transfer. Our process is both cost-effective and collaborative, ensuring all clients are reference clients.

Our mission is to be honest brokers of information in our consulting services and the software we represent.

## **Our History**

Since 1995, Predictive Engineering has continually expanded its client base. Our clients include many large organizations and industry leaders such as SpaceX, Nike, General Electric, Navistar, FLIR Systems, Sierra Nevada Corp, Georgia-Pacific, Intel, Messier-Dowty and more. Over the years, Predictive Engineering has successfully completed more than 800 projects, and has set itself apart on its strong FEA, CFD and LS-DYNA consulting services.

# Engineering Solutions Shanghai Hengstar Tech.



## Shanghai Hengstar

[www.hengstar.com](http://www.hengstar.com)

**Center of Excellence:** Hengstar Technology is the first LS-DYNA training center of excellence in China. As part of its expanding commitment to helping CAE engineers in China, Hengstar Technology will continue to organize high level training courses, seminars, workshops, forums etc., and will also continue to support CAE events such as: China CAE Annual Conference; China Conference of Automotive Safety Technology; International Forum of Automotive Traffic Safety in China; LS-DYNA China users conference etc.

**On Site Training:** Hengstar Technology also provides customer customized training programs on-site at the company facility. Training is tailored for customer needs using LS-DYNA such as material test and input keyword preparing; CAE process automation with customized script program; Simulation result correlation with the test result; Special topics with new LS-DYNA features etc..

**Distribution & Support:** Hengstar distributes and supports LS-DYNA, LS-OPT, LS-Prepost, LS-TaSC, LSTC FEA Models; Hongsheng Lu, previously was directly employed by LSTC before opening his distributorship in China for LSTC software. Hongsheng visits LSTC often to keep update on the latest software features.

Hengstar also distributes and supports d3View; Genesis, Visual DOC, ELSDYNA; Visual-Crash Dyna, Visual-Process, Visual-Environment; EnkiBonnet; and DynaX & MadyX etc.

## Consulting

As a consulting company, Hengstar focuses on LS-DYNA applications such as crash and safety, durability, bird strike, stamping, forging, concrete structures, drop analysis, blast response, penetration etc with using LS-DYNA's advanced methods: FEA, ALE, SPH, EFG, DEM, ICFD, EM, CSEC..

Contact: JSOL Corporation Engineering Technology Division [cae-info@sci.jsol.co.jp](mailto:cae-info@sci.jsol.co.jp)



**Cloud computing services  
for  
JSOL Corporation LS-DYNA users in Japan**

**JSOL Corporation is cooperating with chosen  
cloud computing services**

**JSOL Corporation, a Japanese LS-DYNA distributor for Japanese LS-DYNA customers.**

LS-DYNA customers in industries / academia / consultancies are facing increased needs for additional LS-DYNA cores

In calculations of optimization, robustness, statistical analysis, we find that an increase in cores of LS-DYNA are needed, for short term extra projects or cores.

JSOL Corporation is cooperating with some cloud computing services for JSOL's LS-DYNA users and willing to provide short term license.

This service is offered to customers using Cloud License fee schedule, the additional fee is less expensive than purchasing yearly license.

**The following services are available (only in Japanese). HPC OnLine:**

NEC Solution Innovators, Ltd. - [http://jpn.nec.com/manufacture/machinery/hpc\\_online/](http://jpn.nec.com/manufacture/machinery/hpc_online/)

**Focus** - Foundation for Computational Science  
<http://www.j-focus.or.jp>

**Platform Computation Cloud** - CreDist.Inc.

**PLEXUS CAE**

Information Services International-Dentsu, Ltd. (ISID) <https://portal.plexusplm.com/plexus-cae/>

**SCSK Corporation** - <http://www.scsk.jp/product/keyword/keyword07.html>

# Cloud - HPC Services - Subscription **RESCALE**

[www.rescale.com](http://www.rescale.com)



## **Rescale: Cloud Simulation Platform**

### **The Power of Simulation Innovation**

We believe in the power of innovation. Engineering and science designs and ideas are limitless. So why should your hardware and software be limited? You shouldn't have to choose between expanding your simulations or saving time and budget.

Using the power of cloud technology combined with LS-DYNA allows you to:

- Accelerate complex simulations and fully explore the design space
- Optimize the analysis process with hourly software and hardware resources
- Leverage agile IT resources to provide flexibility and scalability

### **True On-Demand, Global Infrastructure**

Teams are no longer in one location, country, or even continent. However, company data centers are often in one place, and everyone must connect in, regardless of office. For engineers across different regions, this can cause connection issues, wasted time, and product delays.

Rescale has strategic/technology partnerships with infrastructure and software providers to offer the following:

- Largest global hardware footprint – GPUs, Xeon Phi, InfiniBand
- Customizable configurations to meet every simulation demand
- Worldwide resource access provides industry-leading tools to every team
- Pay-per-use business model means you only pay for the resources you use
- True on-demand resources – no more queues

### **ScaleX Enterprise: Transform IT, Empower Engineers, Unleash Innovation**

The ScaleX Enterprise simulation platform provides scalability and flexibility to companies while offering enterprise IT and management teams the opportunity to expand and empower their organizations.

# Cloud - HPC Services - Subscription **RESCALE**

---

## Rescale Cloud Simulation Platform

[www.rescale.com](http://www.rescale.com)

ScaleX Enterprise allows enterprise companies to stay at the leading edge of computing technology while maximizing product design and accelerating the time to market by providing:

- Collaboration tools
- Administrative control
- API/Scheduler integration
- On-premise HPC integration

### Industry-Leading Security

Rescale has built proprietary, industry-leading security solutions into the platform, meeting the needs of customers in the most demanding and competitive industries and markets.

- Manage engineering teams with user authentication and administrative controls
- Data is secure every step of the way with end-to-end data encryption
- Jobs run on isolated, kernel-encrypted, private clusters
- Data centers include biometric entry authentication
- Platforms routinely submit to independent external security audits

Rescale maintains key relationships to provide LS-DYNA on demand on a global scale. If you have a need to accelerate the simulation process and be an innovative leader, contact Rescale or the following partners to begin running LS-DYNA on Rescale's industry-leading cloud simulation platform.

**LSTC - DYNAmore GmbH JSOL Corporation**

Rescale, Inc. - 1-855-737-2253 (1-855-RESCALE) - [info@rescale.com](mailto:info@rescale.com)

944 Market St. #300, San Francisco, CA 94102 USA



ESI Cloud offers designers and engineers cloud-based computer aided engineering (CAE) solutions across physics and engineering disciplines.

ESI Cloud combines ESI's industry tested virtual engineering solutions integrated onto ESI's Cloud Platform with browser based modeling,

### **With ESI Cloud users can choose from two basic usage models:**

- An end-to-end SaaS model: Where modeling, multi-physics solving, results visualization and collaboration are conducted in the cloud through a web browser.
- A Hybrid model: Where modeling is done on desktop with solve, visualization and collaboration done in the cloud through a web browser.

### **Virtual Performance Solution:**

ESI Cloud offers ESI's flagship Virtual Performance Solution (VPS) for multi-domain performance simulation as a hybrid offering on its cloud platform. With this offering, users can harness the power of Virtual Performance Solution, leading multi-domain CAE solution for virtual engineering of crash, safety, comfort, NVH (noise, vibration and harshness), acoustics, stiffness and durability.

In this hybrid model, users utilize VPS on their desktop for modeling including geometry, meshing and simulation set up. ESI Cloud is then used for high performance computing with an integrated visualization and real time collaboration offering through a web browser.

### **The benefits of VPS hybrid on ESI Cloud include:**

- Running large concurrent simulations on demand
- On demand access to scalable and secured cloud HPC resources
- Three tiered security strategy for your data
- Visualization of large simulation data sets
- Real-time browser based visualization and collaboration
- Time and cost reduction for data transfer between cloud and desktop environments
- Support, consulting and training services with ESI's engineering teams



## VPS On Demand

ESI Cloud features the Virtual Performance Solution (VPS) enabling engineers to analyze and test products, components, parts or material used in different engineering domains including crash and high velocity impact, occupant safety, NVH and interior acoustics, static and dynamic load cases. The solution enables VPS users to overcome hardware limitations and to drastically reduce their simulation time by running on demand very large concurrent simulations that take advantage of the flexible nature of cloud computing.

### Key solution capabilities:

- Access to various physics for multi-domain optimization
- Flexible hybrid model from desktop to cloud computing
- On demand provisioning of hardware resources
- Distributed parallel processing using MPI (Message Passing Interface) protocol
- Distributed parallel computing with 10 Gb/s high speed interconnects

## Result visualization

ESI Cloud deploys both client-side and server-side rendering technologies. This enables the full interactivity needed during the simulation workflow along with the ability to handle large data generated for 3D result visualization in the browser, removing the need for time consuming data transfers. Additionally ESI Cloud visualization engine enables the comparisons of different results through a multiple window user interface design.

### Key result visualization capabilities:

- CPU or GPU based client and server side rendering
- Mobility with desktop like performance through the browser
- 2D/3D VPS contour plots and animations
- Custom multi-window system for 2D plots and 3D contours
- Zooming, panning, rotating, and sectioning of multiple windows

## Collaboration

To enable real time multi-user and multi company collaboration, ESI Cloud offers extensive synchronous and asynchronous collaboration capabilities. Several users can view the same project, interact with the same model results, pass control from one to another. Any markups, discussions or annotations can be archived for future reference or be assigned as tasks to other members of the team.

### Key collaboration capabilities:

- Data, workflow or project asynchronous collaboration
- Multi-user, browser based collaboration for CAD, geometry, mesh and results models
- Real-time design review with notes, annotations and images archiving and retrieval
- Email invite to non ESI Cloud users for real time collaboration

## TOYOTA - Total Human Model for Safety – THUMS



The Total Human Model for Safety, or THUMS®, is a joint development of Toyota Motor Corporation and Toyota Central R&D Labs. Unlike dummy models, which are simplified representation of humans, THUMS represents actual humans in detail, including the outer shape, but also bones, muscles, ligaments, tendons, and internal organs. Therefore, THUMS can be used in automotive crash simulations to identify safety problems and find their solutions.

Each of the different sized models is available as sitting model to represent vehicle occupants



and as standing model to represent pedestrians.



The internal organs were modeled based on high resolution CT-scans.

THUMS is limited to civilian use and may under no circumstances be used in military applications.

**LSTC is the US distributor for THUMS.** Commercial and academic licenses are available.

For information please contact: [THUMS@lstc.com](mailto:THUMS@lstc.com)

THUMS®, is a registered trademark of Toyota Central R&D Labs.

# ATD - Human Models - Barrier

## LST, An ANSYS Company – Dummy Models

### Crash Test Dummies (ATD)

Meeting the need of their LS-DYNA users for an affordable crash test dummy (ATD), LSTC offers the LSTC developed dummies at no cost to LS-DYNA users.

LSTC continues development on the LSTC Dummy models with the help and support of their customers. Some of the models are joint developments with their partners.

e-mail to: [atds@lstc.com](mailto:atds@lstc.com)

### Models completed and available (in at least an alpha version)

- Hybrid III Rigid-FE Adults
- Hybrid III 50th percentile FAST
- Hybrid III 5th percentile detailed
- Hybrid III 50th percentile detailed
- Hybrid III 50th percentile standing
- EuroSID 2
- EuroSID 2re
- SID-IIs Revision D
- USSID
- Free Motion Headform
- Pedestrian Legform Impactors

### Models In Development

- Hybrid III 95th percentile detailed
- Hybrid III 3-year-old
- Hybrid II
- WorldSID 50th percentile
- THOR NT FAST
- Ejection Mitigation Headform

### Planned Models

- FAA Hybrid III
- FAST version of THOR NT
- FAST version of EuroSID 2
- FAST version of EuroSID 2re
- Pedestrian Headforms
- Q-Series Child Dummies
- FLEX-PLI



# ATD - Human Models - Barrier

## LST, An ANSYS Company – Barrier Models

Meeting the need of their LS-DYNA users for affordable barrier models, LSTC offers the LSTC developed barrier models at no cost to LS-DYNA users.

LSTC offers several Offset Deformable Barrier (ODB) and Movable Deformable Barrier (MDB) models:

- ODB modeled with shell elements
- ODB modeled with solid elements
- ODB modeled with a combination of shell and solid elements
- MDB according to FMVSS 214 modeled with shell elements
- MDB according to FMVSS 214 modeled with solid elements
- MDB according to ECE R-95 modeled with shell elements
- AE-MDB modeled with shell elements
- IIHS MDB modeled with shell elements
- IIHS MDB modeled with solid elements
- RCAR bumper barrier
- RMDB modeled with shell and solid elements

LSTC ODB and MDB models are developed to correlate to several tests provided by our customers. These tests are proprietary data and are not currently available to the public.

All current models can be obtained through our webpage in the LSTC Models download section or through your LS-DYNA distributor.

To submit questions, suggestions, or feedback about LSTC's models, please send an e-mail to: [atds@lstc.com](mailto:atds@lstc.com). Also, please contact us if you would like to help improve these models by sharing test data.



# Social Media

---



## FACEBOOK

[BETA CAE Systems](#)  
[ESI Group](#)

[CADFEM](#)  
[Lenovo](#)



## TWITTER

[BETA CAE Systems](#)  
[ETA](#)

[ESI Group](#)  
[CADFEM](#)      [Lenovo](#)



## LINKEDIN

[BETA CAE Systems](#)  
[DYNAmore Nordic](#)  
[ESI Group](#)

[CADFEM](#)  
[ETA](#)



## YOUTUBE

### YOUTUBE Channel

[BETA CAE Systems](#)  
[CADFEM](#)  
[ESI Group](#)  
[ETA](#)  
[Lancemore](#)  
[Lenovo](#)

### WebSite URL

[www.beta-cae.com](http://www.beta-cae.com)  
[www.cadfem.de](http://www.cadfem.de)  
[www.esi-group.com](http://www.esi-group.com)  
[www.eta.com](http://www.eta.com)  
[www.lancemore.jp/index\\_en.html](http://www.lancemore.jp/index_en.html)

## GOOGLE+

[BETA CAE Systems](#)