

# Advanced Simulation Techniques for Low Speed Vehicle Impacts

L. Ramon-Villalonga, Th. Enderich

Adam Opel GmbH, Rüsselsheim, Germany

## Summary:

During recent years the development of new vehicles has had to cope with continuously emerging requirements, implemented by new legislations and consumer tests (e.g. EuroNCAP) to insure occupant and pedestrian protection as well as new insurance classification tests to improve passenger car damageability and repairability.

In a low speed vehicle impact performed to assess the insurance classification, the damage to the structure of the vehicle should be minimal in order to reduce the repair costs and consequently achieve a lower insurance category. The bumper system is responsible for absorbing the kinetic energy of the vehicle during a low speed impact, and at the same time no other structural parts should be damaged. In addition, there is a target conflict between low speed and other vehicle load cases as well as current styling philosophies so that the bumper system has to satisfy many challenging requirements.

The following paper focuses on low speed crash giving an overview of the actual load cases, describing the requirements that a modern bumper system has to fulfil. Advanced techniques are presented from the importance of the mesh quality through to detailed modelling of some key parts to improve the vehicle performance.

## Keywords:

Low speed crash, AZT, RCAR, crash box, bumper beam, high speed crash, element size, buckling modes

## 1 Introduction

During recent years, there has been an increasing economic pressure within the automotive industry to drive virtual development in order to reduce both development time and the number of physical prototypes. The application of crash simulations is nowadays an integrated part of the vehicle development process. The continuously emerging number of load cases and variants involve more challenging performance requirements, which can only be achieved by means of simulation techniques.

The passive safety load cases can be divided into: high speed crashes for front, side and rear impacts, occupant and pedestrian protection and low speed crashes which are mainly performed for insurance classification purposes. In order to fulfill the new pedestrian protection requirements significant structural changes of the vehicle front end are necessary. These structural changes affect adversely the performance of other safety load cases e.g. high and low speed crashes. Hence it is a challenge to develop a front end structure with an optimal performance for all the load cases.

The performance of low speed impacts is regulated by a number of national and international standards. There are legal requirements based on certain minimum performances for the vehicle homologation in barrier and pendulum tests with velocities ranging from 2.4-8 km/h depending on where the vehicle is marketed (e.g. CMVSS 215 in Canada, 49 CFR 581 in the US, ECE-R42 in Europe). Besides the demands of legislation, these days insurance classification tests are becoming a prerequisite. In Europe, the 15 km/h crash repairability test (also known as Danner test or AZT test) is widely used for insurance rating.

In a low speed impact the vehicle must withstand the crash with minimal damage, so that the repair costs remain low and a certain insurance classification can be achieved. While the bumper system must absorb most of the impact energy, the remaining structure of the vehicle should not undergo plastic deformation. For a bumper system to be designed efficiently, it is essential to have a fine mesh resolution in certain areas. The influence of the mesh sensitivity is discussed in chapter 4. Some vehicle design features which enhance low speed crash performance are described in chapter 5.

## 2 Low Speed Vehicle Impacts

Over the last few years different test configurations for low speed impacts have been developed in different countries, in order to prevent unnecessary damage to the structure of vehicles. This section focuses briefly on the most important European load cases for low speed.

In the early 1980s, the 'Allianz Zentrum für Technik' (AZT) implemented the structural test at 15 km/h, a 40% overlap and 0° rigid barrier for front and rear impact in Europe. The general test set-up for left hand drive is shown schematically in Fig. 1.

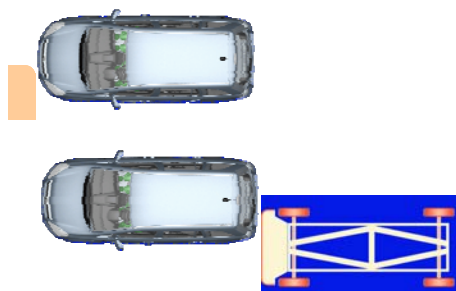
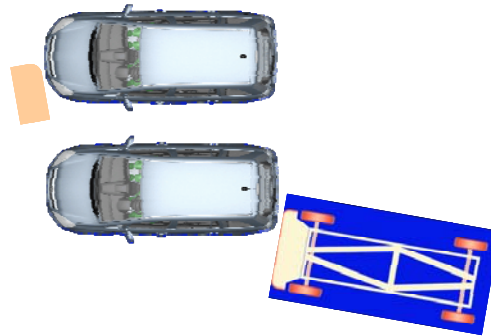

Fig. 1 Front and rear impact with 0° rigid barrier (AZT test)

This test has been adopted by the Research Council for Automobile Repairs (RCAR) as a standard for conducting low speed crash tests. RCAR is an international organization that works towards reducing insurance costs by improving automotive damageability, repairability, safety, and security.

A few vehicle manufacturers have tended to develop their vehicles to achieve the best results under this very specific RCAR test condition but the vehicles have not exhibited a good low speed impact

performance in real world accidents. Minor changes of the impact constellation have resulted in much higher repair costs. For this reason, in 2006 the RCAR test was revised and changed from 0° to 10° impact angle, in order to encourage corner protection and to improve the robustness of the vehicle front end structure as a result of the additional lateral force of the 10° barrier (Fig. 2).



*Fig. 2 Front and rear impact with 10° rigid barrier (AZT test)*

The new configuration can imitate more realistically real world corner impacts, causing more cosmetic damage (e.g. fenders, headlamps, hood, etc.) while the damage to the mechanical parts (e.g. radiator, condenser etc.) is reduced. Due to the lower barrier penetration for the 10° impact compared to the 0° impact the damage to the hood decreases (Fig. 3). Actual trends are to design short hoods, so that the hood remains completely undamaged in the event of a crash at low speed.

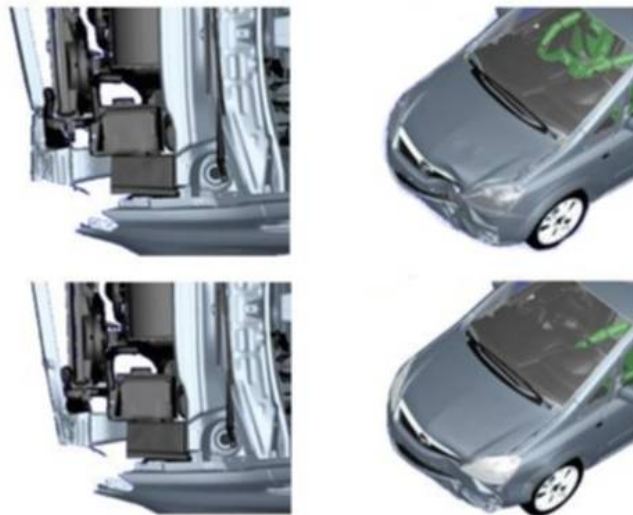

*Fig. 3 Front impact with 0° and 10° rigid barrier (AZT test)*

In addition to the enhanced AZT test, a new bumper test procedure, which should come closer to the damage that occurs in real world impacts, has recently been developed by the RCAR working group. This new test improves the ability of the bumper systems, particularly their capability to prevent the underride and override. Some of the most costly low speed crash damage occurs when vehicle bumpers slide under or over each other and damage is caused to vehicle grilles, headlamps, hoods and fenders. This happens because generally, the bumpers on colliding vehicles do not align. In this new test configuration the car is crashed into a barrier designed to imitate a real vehicle bumper. The bumper barrier is composed of a steel body, a plastic absorber, a plastic cover and a back stop (Fig. 4). The back stop reduces the amount of intrusion into the vehicle and is supposed to create more realistic cosmetic damage. The tests include front and rear full-width impacts at 10 km/h. In North America front and rear corner impacts at 5 km/h are also being taken into consideration.

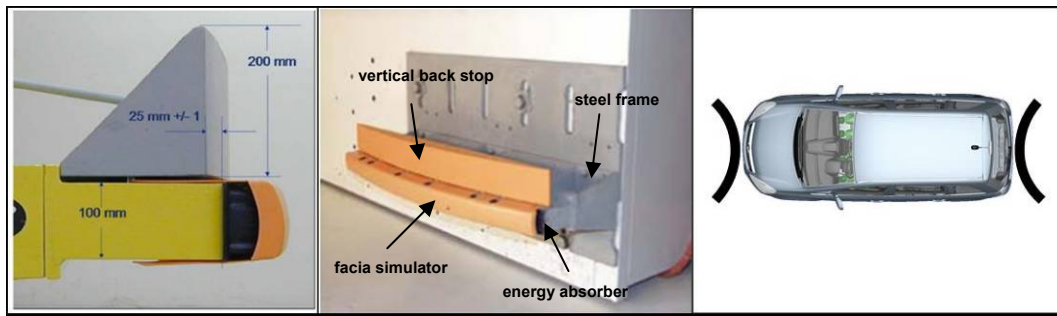

Fig. 4 New RCAR bumper barrier

### 3 Requirements on Modern Bumper Systems

Favorable insurance categories, sufficient deformable zones for pedestrian protection and conflicting low speed legislation aspects require an effective design of bumper systems. The modern bumper system has the function of absorbing the energy of the low speed crash, thus avoiding higher vehicle damage. The energy absorption capability of the bumper system during a crash is evaluated by the load-displacement response. The area under the corresponding load-displacement curve is a measure of the energy absorbed (Fig. 5). During a low speed impact, the bumper system has the function of preventing damage to the body-in-white (BIW). Hence the maximum impact load transmitted through the system has to be limited. The maximal displacement is specified by the vehicle design. The ideal bumper system has a load-displacement response which acts as a step function: the load rapidly reaches the maximum allowed value and remains there throughout the crash (Fig. 5).

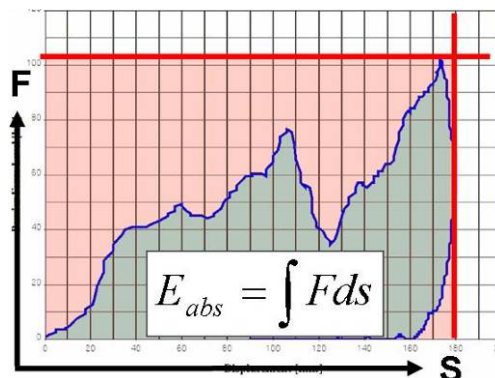

Fig. 5 Force-displacement curve

The modern screwed bumper systems are composed of a bumper beam and two energy absorber elements (e.g. crash box). In contrast, the old bumper systems were welded to the BIW instead of being screwed. Fig. 6 shows the differences of the bumper design between the Opel Zafira I and the new Opel Zafira II. The advantage of the modern bumper system is that it is possible to replace each part individually in the event of damage, without the necessity to cut or weld. The energy absorbing crash box is placed behind the bumper beam and attached to the front rail of the vehicle. The crash box has to crush in a specific way, so that the forces and bending moments transmitted to the front rail are limited and the rail does not undergo any significant plastic deformation. As a result the rail does not need to be repaired after a low speed impact. In parallel, both the cosmetic damage (e.g. fenders, headlamps, hood, etc.) and the damage to the expensive mechanical parts (e.g. radiator, condenser, etc.) have to be kept as low as possible.

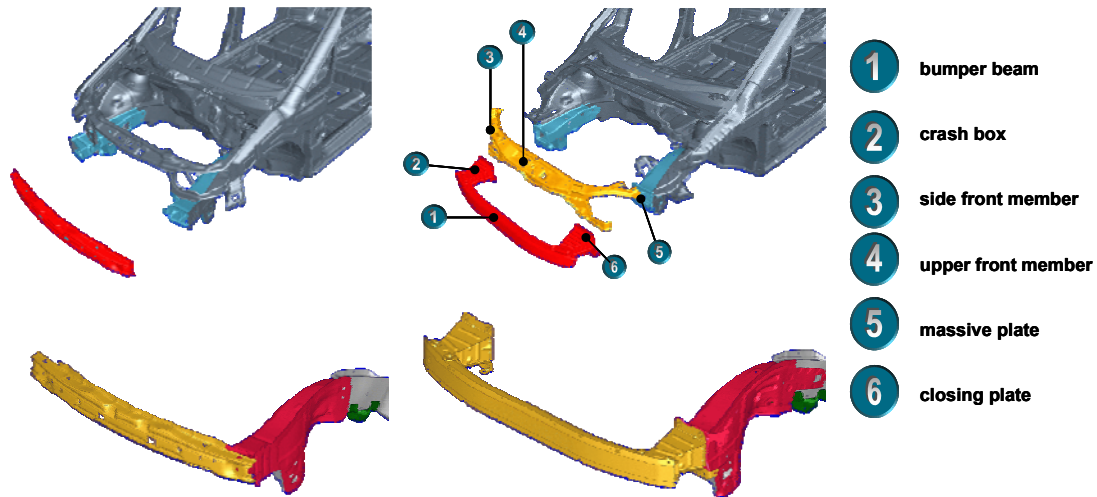

Fig. 6 Front end structure of Zafira I and Zafira II

New bumper systems have some disadvantages: for example not only does the production complexity increase but also the cost, weight and vehicle front overhang. Firstly the longer vehicle overhang is caused by the increased distance between the bumper beam and radiator (in order to avoid damage to this part during a low speed crash). In addition to that, the implementation of deformation elements in front of the bumper beam increases the required package space. A third factor responsible for the large front overhang is the stiff interface area (e.g. closing plate and massive plate) between the energy absorber elements and the front rail. At the same time there is a desire to improve the compactness of the vehicle for styling reasons and to keep the overhang low, making the energy management more difficult. Fig. 7 shows the increased front overhang of the Opel Zafira II compared to the front overhang of the Opel Zafira I.

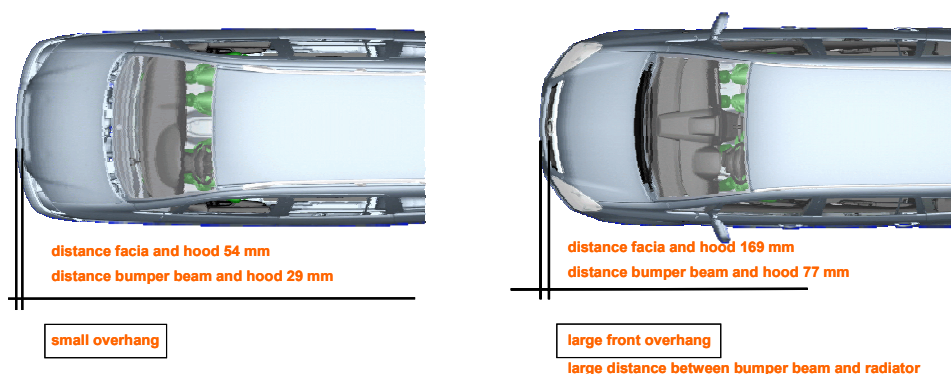

Fig. 7 Front overhang comparison between Opel Zafira I and Opel Zafira II

As already mentioned low speed impacts are regulated by an amount of different legal requirements and insurance classification tests. It is a challenge to design the most efficient bumper system for all the existing load cases simultaneously, because the requirements are to some extent contradictory, above all the requirements between Europe and North America. While the bumper beam and the crash box should be designed stiff in order to pass the pendulum demands from Canada (CMVSS215) and USA (49 CFR 581), the crash box has to be able to crush in the Danner Test, without any plastic deformation of the front rail. To solve this problem one alternative could be to design different bumper systems for North America and Europe.

Structural changes to the vehicle front end structure to achieve pedestrian protection demands can affect adversely the low speed performance. In order to ensure the required protection for pedestrians, the vehicle must absorb the impact energy by means of a deformable soft structure which has sufficient deformation space. For lower leg protection, an optimized low-density foam in front of the bumper cross-member can be integrated. This foam reduces the efficiency of the low speed bumper system, so that the barrier intrusion is higher. Hence, without further measures, the vehicle damage and the repair costs would increase, which would intensify the insurance classification. In order to



avoid these effects, several measures have to be implemented. In section 5 some measures are described which significantly helped to reduce damage repair costs to the Opel Zafira II.

An effective design of the bumper system must also fulfill certain requirements regarding high speed crashes. During a high speed impact, the crash box should crush first and the front rail should be able to absorb most of the deformation energy, so that the safety cage does not undergo any relevant deformation. Due to the RCAR requirements the force level between crash box and front rail is different and the crash box deformation cannot be efficiently used for high speed crash. For this reason the transition between front and elongation front rail has to be reinforced and consequently, the production complexity, weight, as well as the costs increase (Fig. 8).

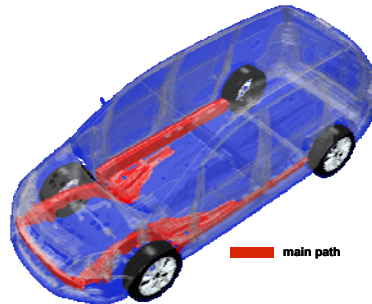

Fig. 8 Reinforced main load path

#### 4 Mesh Sensitivity of a Crash Box

For full vehicle crash analysis small finite elements are undesired, since they require a small critical time step for the simulation with an explicit procedure and considerable calculation resource is necessary. However the characteristics of the underlying mesh have a significant effect on the numerical simulation results and a compromise between element size and computation time has to be met. All relevant deforming parts of a finite element model should have a fine resolution mesh and model coarsening should be applied to all non-deforming parts, while a transition zone should be maintained.

A model size study has been carried out to show the potential impact of different mesh sizes on simulation results. Since in low speed impacts the crash box is the main component which absorbs the kinetic energy, a total of six different mesh sizes for a crash box were analyzed. The following table shows exemplarily for three of the six evaluated meshes: the minimum size, average edge length (AEL), maximum size, total number of elements and percentage of triangular elements (Fig. 9).

Mesh [-]	Minimum size [mm]	Average edge length [mm]	Maximum size [mm]	Number of elements [-]	Trias [%]
fine	0.8	1.8	3.5	26263	4.9
medium	2.0	3.4	5.0	10770	7.1
coarse	3.7	5.6	8.6	3560	16.6

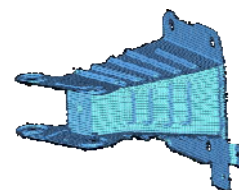

Fig. 9 Mesh sizes for a crash box

First of all an evaluation of a crash box for all mesh sizes under axial loading was conducted. A simple model with a crash box and a rigid wall was modeled. The rigid wall was moved with a constant velocity to crush the crash box, while the rear wall of the crash box was fully constrained. The internal energy absorbed by the crash box and the mean reaction force of the rigid wall are illustrated in Fig. 10. The coarse meshes can absorb more energy because they are stiffer than the fine meshes. The simulation results converge as the discretization of the crash box becomes finer. Similar results are described in [1]. An element size of 2.5 mm provides mesh independent results whereas a finer mesh does not increase the accuracy of the results.

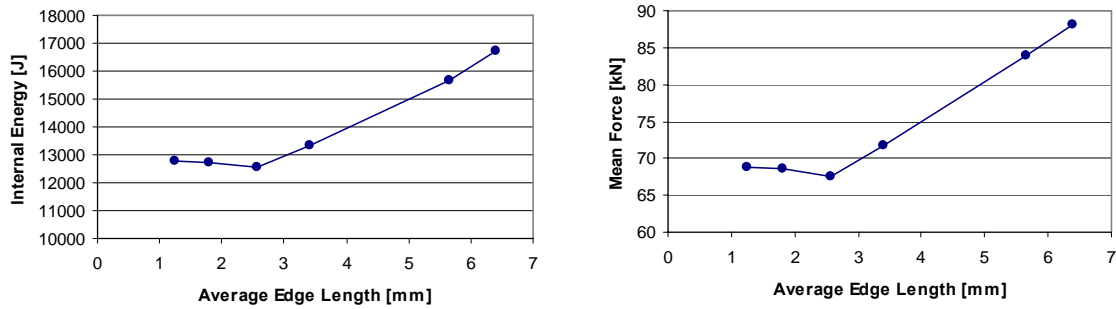

Fig. 10 Internal energy and mean force

The following diagram depicts the influence of the element size on the computational time (Fig. 11). It is obvious that the finer the mesh is, the more calculation resource is needed. For the evaluated crash box an average element length of 2.5 mm or lower gives almost the same results, but in contrast the computational time for these meshes increases considerably. The simulation time of the 2.5 mm mesh is only 32% of the simulation time of the finest mesh evaluated in this study.

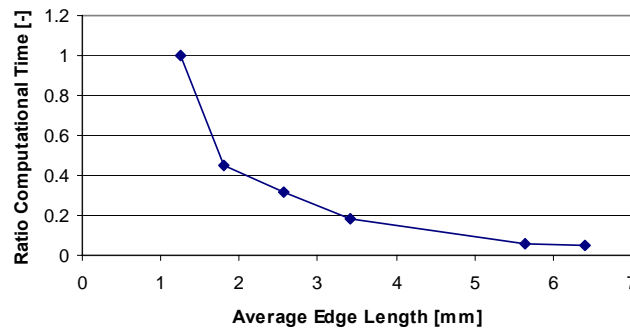

Fig. 11 Computational time

Fig. 12 illustrates the influence of the element size on the crash buckling modes. The sensitivity of the results decreases as the element size becomes lower, allowing a finer mesh to capture higher curvature buckling modes. Using a sufficient fine mesh, a smooth representation of the deformed geometry can be achieved. The influence of the mesh resolution on the deformed geometry is shown in [2].

AEL [mm] \ State	1.3	1.8	2.5	3.4	5.6	6.4
4						
6						
7						

Fig. 12 Buckling modes

The second step of the study was to evaluate the influence on the mesh of the crash box in a component model for the AZT load case. The component model was composed of a bumper system (beam and crash boxes), load cells and a dolly. The dolly, representing the vehicle mass, with the bumper system impacts against a 0° rigid barrier with a 40% overlap at 15 km/h.

Fig. 13 depicts the simulation results of the meshes in the table above (Fig. 9) compared to the experimental test data. A reasonable correlation is obtained between the simulation and test data for the fine mesh with an element size of 1.8 mm. The coarse mesh (AEL 5.6 mm) is not able to represent the maximum load peak. A comparison between the fine meshes (AEL 1.3, 1.8 and 2.5 mm) emphasizes that an element size of 2.5 mm is sufficient to obtain realistic results and a finer mesh does not significantly improve the accuracy (Fig. 14).

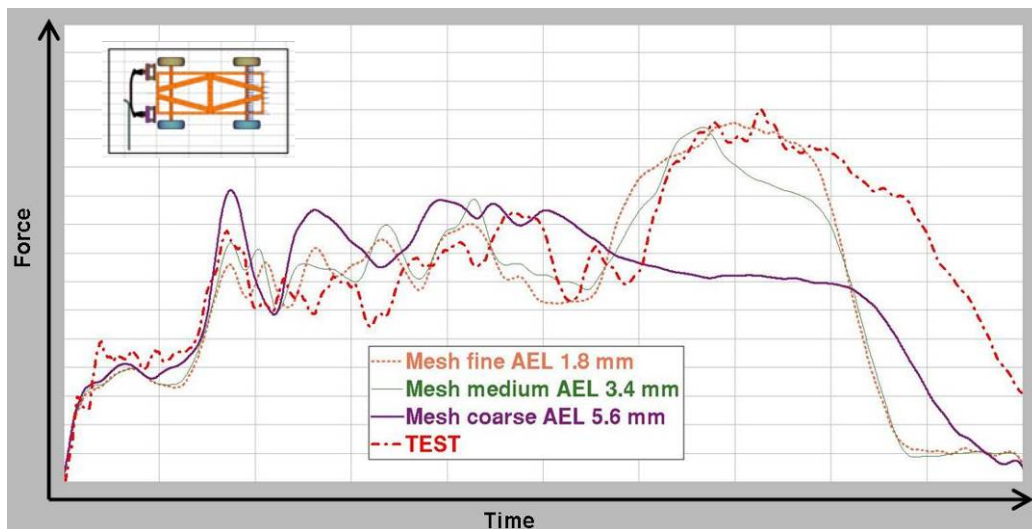

Fig. 13 Force-time diagram

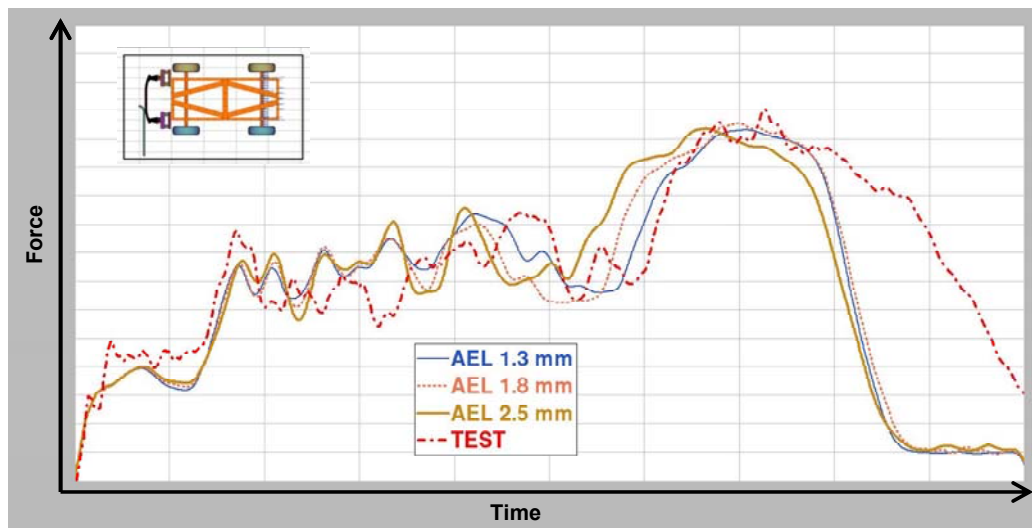

Fig. 14 Force-time diagram

At the beginning of the vehicle development process, the bumper system is developed on the basis of dolly models. However, for the development of an effective bumper system, it is essential to consider both the package components as well as the vehicle front end structure. This can be achieved by designing the bumper system within a vehicle model. The last step of the study was to evaluate the influence on the mesh size of the crash box on a vehicle sub-model for low speed crash. The same meshes were used as those in the dolly model. The vehicle impacts against a 0° rigid barrier with



15 km/h and a 40% overlap. Once more the convergence of the results can be observed with increasing mesh density (Fig. 15).

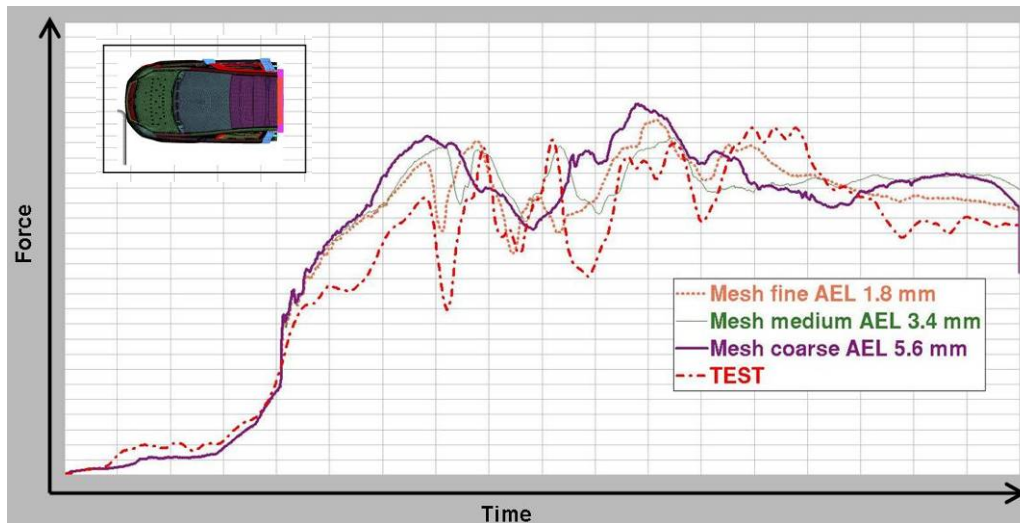

Fig. 15 Force-time diagram

## 5 Vehicle Design Features for Friendly Repairability

In this section some vehicle design features are described which significantly helped to reduce damage repair costs to the Opel Zafira II. For a low insurance classification it is very important that not only the welded parts remain undamaged but also the damage to the cosmetic parts and to the expensive mechanical parts such as radiator and condenser is kept to the minimum.

The radiator, due to its specific position behind the bumper beam can be easily damaged during a low speed collision, if no special vehicle design for friendly repairability is considered. Several measures were implemented in the Opel Zafira II to reduce the damageability of the radiator. The radiator is bolted to the vehicle structure by means of upper and lower plastic brackets with load limiters. The brackets are intended to fail during the impact, so that the radiator can be pushed backwards approx. 40 mm without being damaged (Fig. 16). During the first tests with prototypes some issues appeared in the radiator module of the Opel Zafira II: instead of the rupture of the bolted plastic bracket with load limiters, the upper radiator arm broke up causing relevant damage to the radiator (Fig. 17).

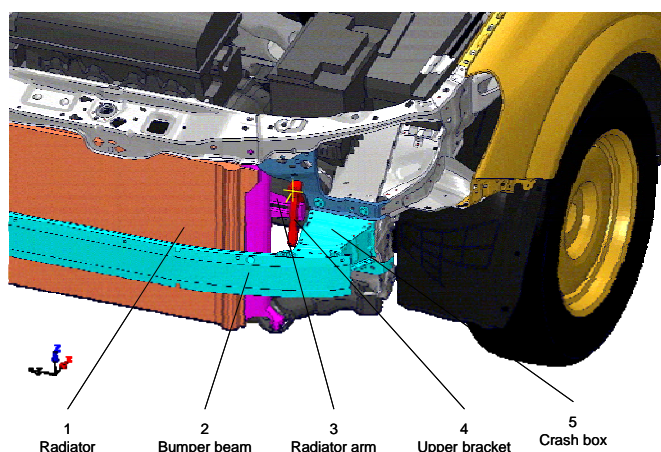

Fig. 16 Radiator with upper bracket

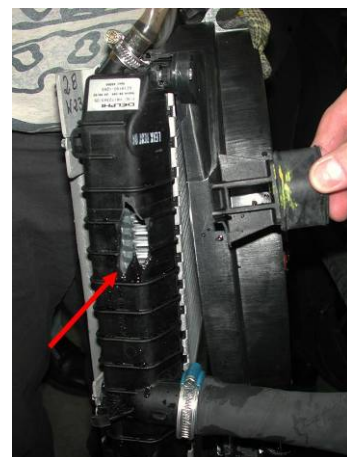

Fig. 17 Radiator with broken upper bracket

Two design measures to solve this issue were applied: the first one was to insert a fragile area in the bracket and the second one was to reinforce the radiator arm. Both the new bracket and the new radiator arm were developed and optimized by means of detailed CAE modeling and then verified by different experimental tests. The new bracket was designed on the one side weak with a cut-out profile

to act as a crush initiator, but at the same time sufficiently stiff to avoid an endurance fracture. The stiffness of the radiator arm was increased by adding thicker ribs (Fig. 18).

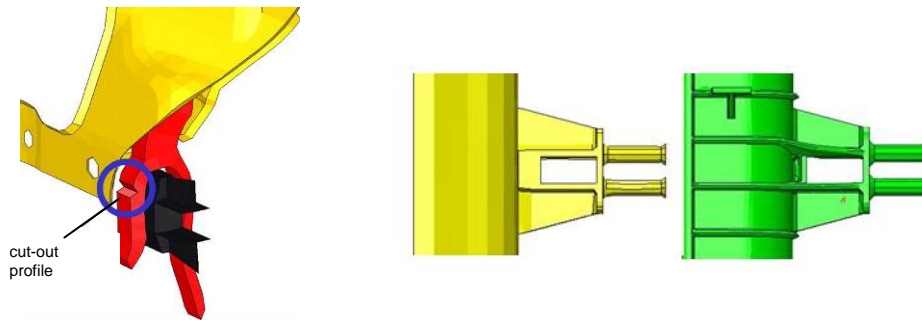

Fig. 18 Bracket with cut-out profile and radiator arm with and without ribs

After various FE iteration loops to achieve the best performance of the bracket, tensile tests were conducted, where the bracket arm with and without the fragile area were pulled until fractured (Fig. 19). The fracture force during the experiment was monitored and compared to the simulation results.



Fig. 19 Experimental and FE tension test

In order to prove the performance of the new developed bracket under fatigue resistance an endurance test was performed. The radiator module with brackets was constrained and erected with a vehicle acceleration signal. Both the bracket and the radiator arm withstood the experiment and did not fail. Several Danner tests were also carried out to confirm the performance of both parts under crash loading.

To improve the kinematics of the radiator a “pushing bracket” for the lower bumper stiffener was incorporated, so that the radiator is able to move backwards during the low speed impact, without canting (Fig. 20).

Not only the package components but also the exterior body parts such as fenders and doors can be easily damaged during a low speed collision. As an example, the headlamp may rotate outwards into the fender pushing the fender towards the front door, resulting in both fender and front door paint damage. In order to limit this vehicle paint damage several measures were implemented in the headlamp of the Opel Zafira II. The development of the new headlamp was optimized on the basis of FE analysis. In the new headlamp cage, some fins were integrated and in the upper side member, a capture bracket was bolted in order to prevent the headlamp being pushed outwards into the fender (Fig. 20).

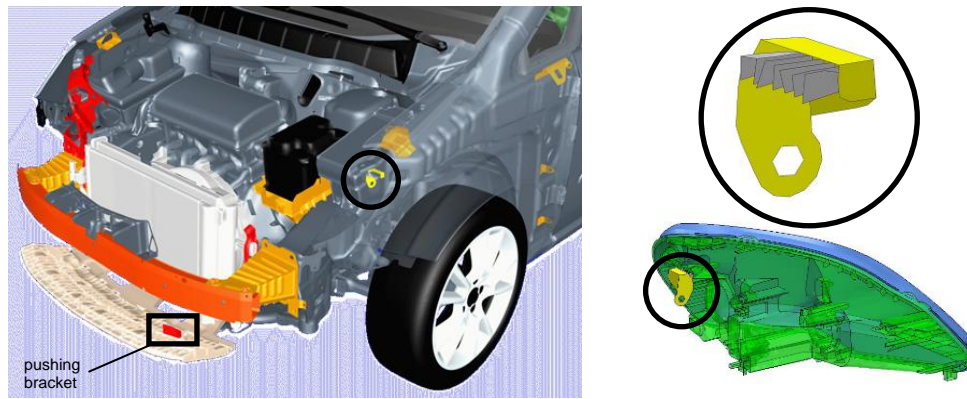

Fig. 20 Capture bracket to avoid fender and front door damage

## 6 Summary

The different low speed legislations and insurance tests are a new very demanding challenge for the automotive industry, which requires an effective design of the bumper system. In addition the optimization of the low speed performance is often in conflict with other crash load cases (e.g. pedestrian protection and high speed crash) and styling philosophies.

For a bumper system to be designed efficiently, it is essential to have a fine mesh resolution in the deformation areas in order to achieve accurate results. This paper outlines that an element size of 2.5 mm for a crash box is necessary to obtain realistic results for the internal energy, mean force and buckling modes.

The paper presents some examples of vehicle design features that optimize the low speed impact performance and ensure a friendly reparability for the Opel Zafira II, without compromising occupant safety, crashworthiness and pedestrian protection.

## 7 Literature

- [1] Ratzel, M., Du Bois, P., Fredriksson, L., Schneider, D., A study of mesh sensitivity for crash simulations: comparison of manually and batch meshed models, 4. LS-Dyna Anwenderforum, Bamberg, 2004
- [2] Du Bois, P., Crashworthiness Engineering with LS-Dyna, H.E.N.V., 2000

