

Comparison between Experimental and Numerical Results of Electromagnetic Tube Expansion

Jianhui Shang, Steve Hatkevich, Larry Wilkerson

American Trim LLC, 999 W Grand Ave, Lima, OH 45801 USA

Abstract

Electromagnetic forming is a complex coupled mechanical-thermal-electromagnetic phenomenon. To accurately simulate this high-velocity and high-strain-rate process, electromagnetism (EM) module of LS-DYNA has been developed. In this paper, the predictive ability of the EM module is assessed through a comparison between experimental and numerical results of electromagnetic tube expansion. The experiment was to apply electromagnetic forming for expansion of Al 6061-T6 tube. Photon Doppler Velocimetry (PDV) was used to measure the velocity during the tube expansion. This process was also modeled using LS-DYNA EM module. Different parameters of Johnson-Cook strength model for Al 6061-T6 were applied to verify the constitutive model parameters for Al 6061-T6. Moreover, 2D axi-symmetric simulations with different mesh densities were performed in this case. A comparison of the expansion velocity between experimental and numerical results is presented and discussed. The good agreement was found between the experimental and numerical results.

Introduction

Electromagnetic forming is a coupled mechanical-thermal-electromagnetic phenomenon, which involves high velocity and high strain rate. For high-strain-rate deformation, suitable constitutive models with proper parameters are critical to perform numerical analysis and to predict material deformation. There are several techniques to obtain the experimental data on constitutive properties at high strain rate, such as dropweight machines, split Hopkinson pressure bars, Taylor impact and shock loading by plate impact [1]. In 1965, Niordson [2] pioneered the experimental investigation of high strain rate tests with electromagnetically driven ring expansion. In the 1980s, Gourdin [3] extended the capability of electromagnetically driven ring expansion by using Velocity Interferometer Systems for Any Reflector (VISARs) to measure the ring expansion velocity. But VISARs are difficult to use routinely for velocity measurements and therefore this test was not widely used. Recently, Daehn [4] proposed to apply electromagnetically driven ring expansion for determination of the high-strain-rate constitutive properties with the help of the cutting edge technology, Photon Doppler Velocimetry (PDV), which has the capability to accurately measure the ring expansion velocity and also is easy to apply. Johnson [5] furthered the development with Fully Instrumented Ring Expansion (FIRE) system with electromagnetic actuator and exploding wire actuator.

Moreover, an electromagnetism (EM) module has been developed by LSTC for the numerical simulation of electromagnetic forming [6]. In this module, the electric current going through the actuator (coil) can be set as the input and then the workpiece deformation (such as strain, strain

rate, stress, velocity...) can be calculated if the material properties are known. In the case of electromagnetic ring expansion, the ring expansion velocity can be measured using PDV and the electric current can be measured using a Rogowski coil. Therefore, EM module can be applied to calculate the expansion velocity with the measured current as input, and the predicted expansion velocity can be compared to the measured velocity, which will help identify constitutive models used in the finite element simulation. Henchi [7] proposed to apply LS-OPT to determine the constitutive properties by optimizing the parameters of Johnson-Cook model with the combination of EM simulation and PDV measurements.

In this paper, a typical EM expansion experiment with Al 6061-T6 tube is presented. Then the simulation results using the EM module with several constitutive models of Al 6061-T6 are presented and compared to the velocity measurements. The better agreement between the numerical results and the experiment results should indicate the more appropriate constitutive model. In this way, the proper parameters for the Johnson-Cook constitutive models of Al 6061-T6 can be verified. Moreover, 2D axi-symmetric simulations with different mesh densities are performed in this case, since mesh density in the models has large effects on the simulation time and accuracy.

Experimental Setup and Results

Figure 1 shows the schematic layout of the EM tube expansion experiment. The capacitor bank used in this experiment was a 16kJ Magneform machine with the maximum charging voltage of 8.66kV, a total capacitance of 426 μ F and an internal inductance of around 100nH. A 3-turn coil was connected to the capacitor bank to generate electromagnetic forces to expand the tube outwards. The coil was made of Cu with 61mm outer diameter, 6.3mm x 6.3mm square cross section and a 3.6mm pitch, which is shown in Figure 2. The Al 6061-T6 tubes used here have 63.5mm outer diameter, 0.89mm wall thickness and 45mm length.

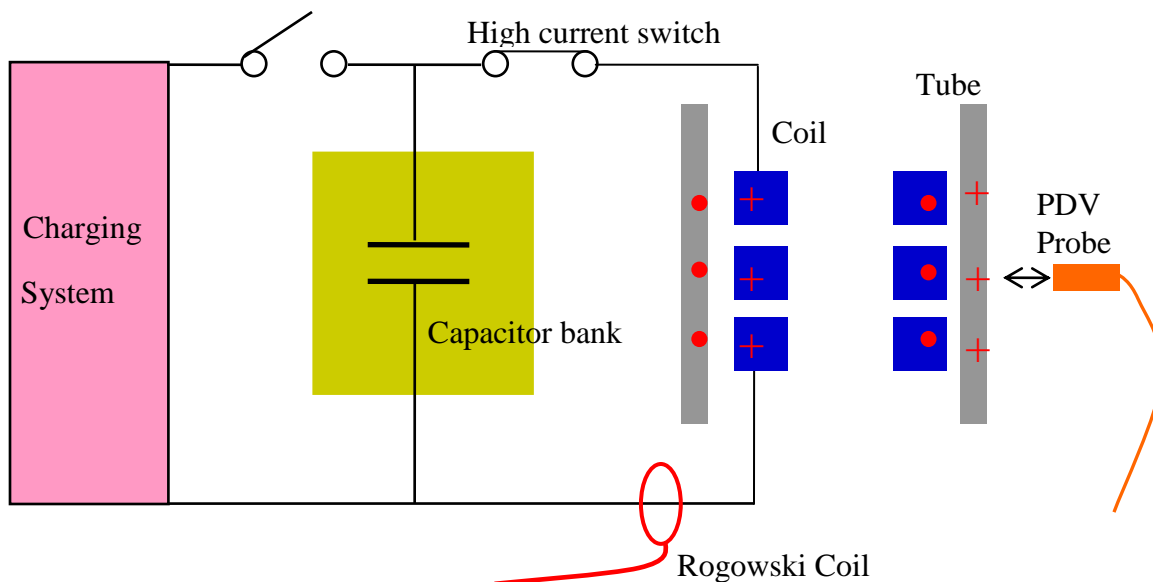

Figure 1. Schematic layout of EM tube expansion experiments

During the EM tube expansion tests, one PDV probe was applied to measure the expansion velocities, shown in **Fehler! Verweisquelle konnte nicht gefunden werden.**. The PDV probe aimed at the middle of the 3-turn coil, which was to capture the maximum expansion velocity. The measurement principles of PDV can be found in other papers [4, 5]. Moreover, a Rogowski coil was applied to measure the electric current going through the 3-turn coil during EM tube expansion tests.

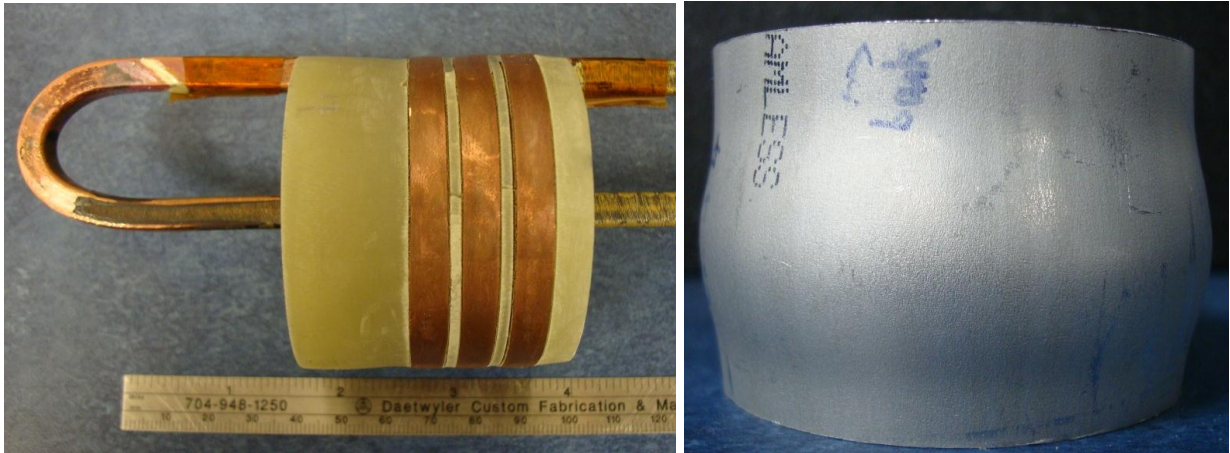

Figure 2. Photo of the 3-turn coil (left) and the Al 6061-T6 tube after 1.2 kJ expansion (right)

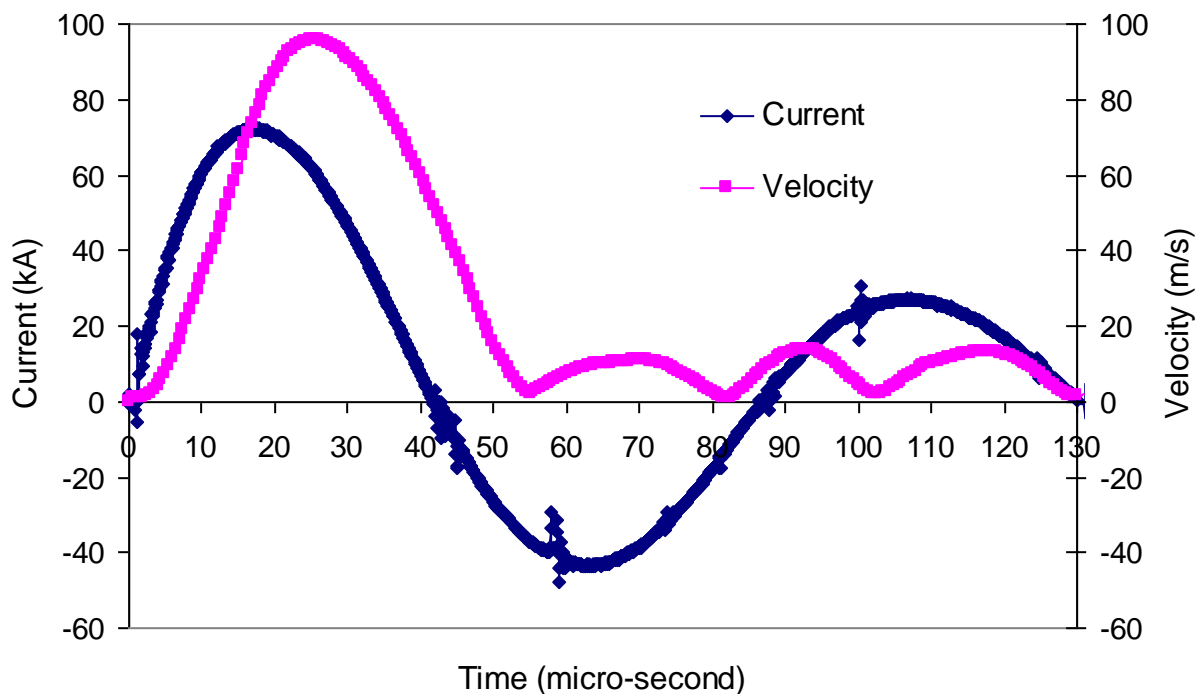

Figure 3. Measured current trace and velocities for 1.2 kJ Al 6061-T6 tube expansion

Figure 3 is the measured current trace and velocities in the case of 1.2 kJ Al 6061-T6 tube expansion. The measurements show that the electric current in the 3-turn coil reached the peak value of 73.5 kA at 17.0 μ s. At the position corresponding to the PDV probe, the Al tube was accelerated to the peak velocity of 95.6m/s within 26.5 μ s and then decelerated to the velocity of 2.0m/s at 55.0 μ s. After that, the Al tube began to vibrate and decay to become stationary.

Numerical Simulation

The numerical simulation was performed using the EM module available in the “beta” 980 version of LS-DYNA. In this module, Finite Element Method (FEM) is coupled with Boundary Element Method (BEM) to compute magnetic field, electric field and induced current by solving Maxwell equations in eddy-current approximation. FEM is applied to solve Maxwell equations for the solid conductors and BEM is used for the surrounding air. The detailed introduction of this module can be found in [6].

A 2D axisymmetric model was built for the numerical simulation, shown in Figure 4. Figure 4 also shows the position where the expansion velocity was measured. There are three parts: the 3-turn Cu coil, the Al 6061-T6 tube and the G10 holder. The 3-turn Cu coil and the Al tube were meshed using eight-node hexagonal solid elements, which are required for the solid conductors in EM module. The G10 holder was meshed with shell elements since G10 Garolite is non-conductive material.

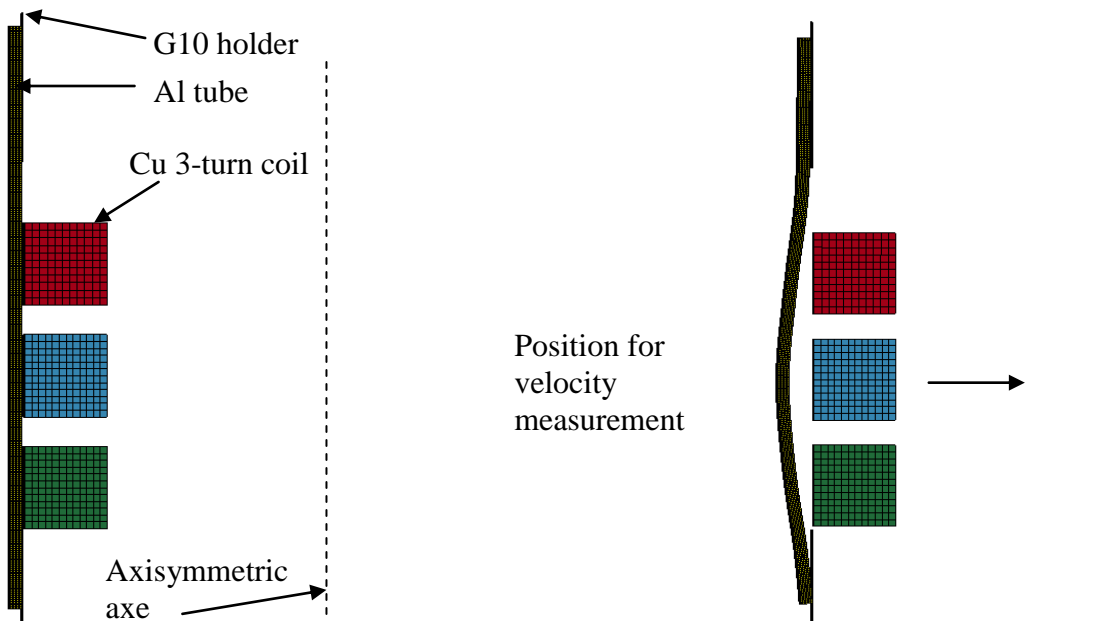

Figure 4. 2D axisymmetric model of the 3-turn Cu coil, Al 6061-T6 tube and G10 holder at initial time (left) and at the end of simulation (right)

The G10 holder was modelled as a rigid body since it did not have plastic deformation. The 3-turn Cu coil was modelled as elastic material because it did not have plastic deformation during

the 1.2 kJ EM tube expansion. But for the Al 6061-T6 tube, high strain rates and large deformations were involved. Therefore, the Al 6061-T6 tube was modelled using the Johnson-Cook strength model, which has the following form [8]:

$$\sigma = (A + B\varepsilon^n)(1 + C \ln \dot{\varepsilon}) \left[1 - \left(\frac{T - T_{room}}{T_m - T_{room}} \right)^m \right] \quad (1)$$

where A is yield stress, B is hardening constant, C is strain rate sensitivity, n is hardening exponent, m is thermal softening exponent and T_m is melting temperature. From the literature, three parameter sets of Johnson-Cook strength model for Al 6061-T6 were found and listed in Table 1. For each set of parameters, an EM simulation for the case of 1.2 kJ Al 6061-T6 tube expansion were performed.

	A (MPa)	B (MPa)	C	n	m	T_m (K)
Model 1 [9]	324	114	0.002	0.42	1.34	925
Model 2 [10]	275	500	0.02	0.3	1.0	925
Model 3 [11]	275	255	0	0.30	1.0	925

Table 1: Parameters of Johnson-Cook strength model for Al 6061-T6

Figure 5 show the experimental and numerical simulation results of the expansion velocity. From the figure, it can be seen that the simulation using Model 2 have large difference from the measurements. The simulations using Model 1 and Model 3 agree well with the measurements. The peak velocity of the expansion velocity in the measurement has 3.5% difference from the one predicted with Model 1 and Model 3, and 12.2% difference from the one predicted with Model 2. Model 1 and Model 3 predicted the same peak velocity, but they had some differences at the vibration stage.

Figure 6 shows the effective plastic strain rate and the effective plastic strain at the position where the expansion velocity was measured, according to the numerical simulation using Model 1 for 1.2 kJ tube expansion case. The peak effective plastic strain rate was 3020 s⁻¹ at 25.0μs when the effective plastic strain was 0.033, which is truly a high strain rate. The peak effective plastic strain was 0.095. It should be noted that this experiment applied low energy to expand the Al tube. Much larger expansion velocity and strain rate could be reached if increasing energy or using different set-ups. In this paper, the main purpose was to test the feasibility of using PDV and EM module to verify constitutive models. Therefore, only low energy was applied here.

The comparisons show that the parameters in Model 1 and Model 3 are suitable for Al 6061-T6, but those in Model 2 are not correct. From Table 1, both Model 1 and Model 3 have the very low values of the strain rate sensitivity C, which are 0.002 and 0. Model 2 has much larger values of the strain rate sensitivity C, which is 0.02. Aluminium is traditionally considered to have low strain rate sensitivity. Therefore, the experimental and numerical simulation results in this paper verified this statement, i.e. Al 6061-T6 has very low strain rate sensitivity within the range of 0~3020 s⁻¹ strain rate.

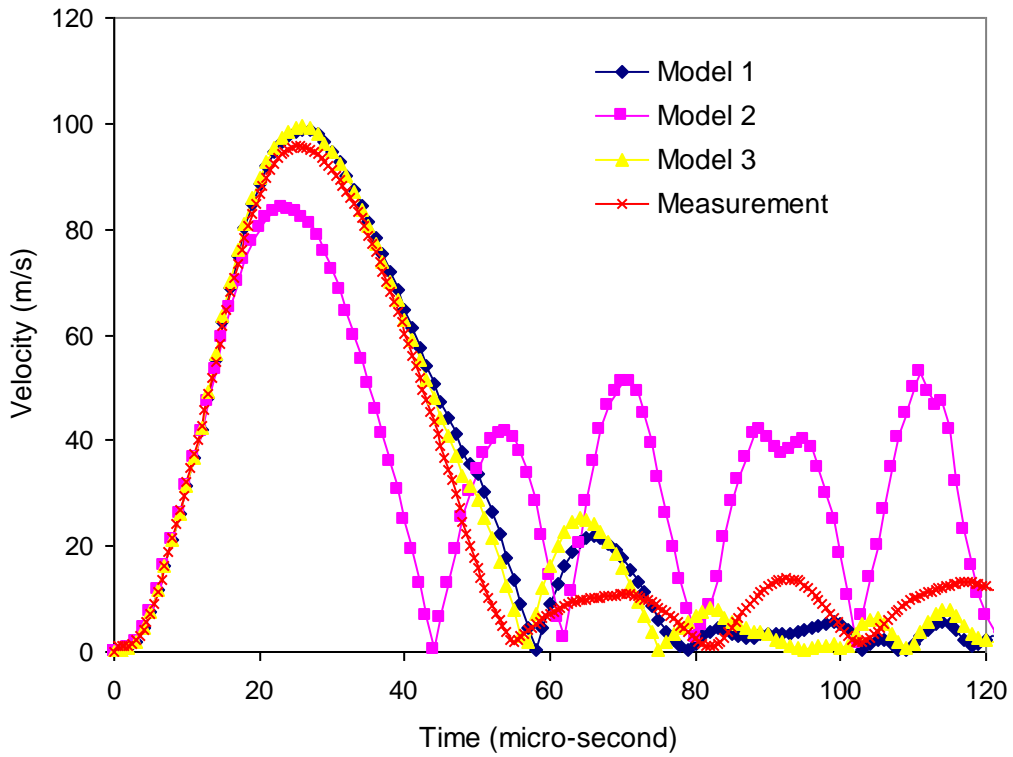

Figure 5. Experimental and numerical simulation results of expansion velocity

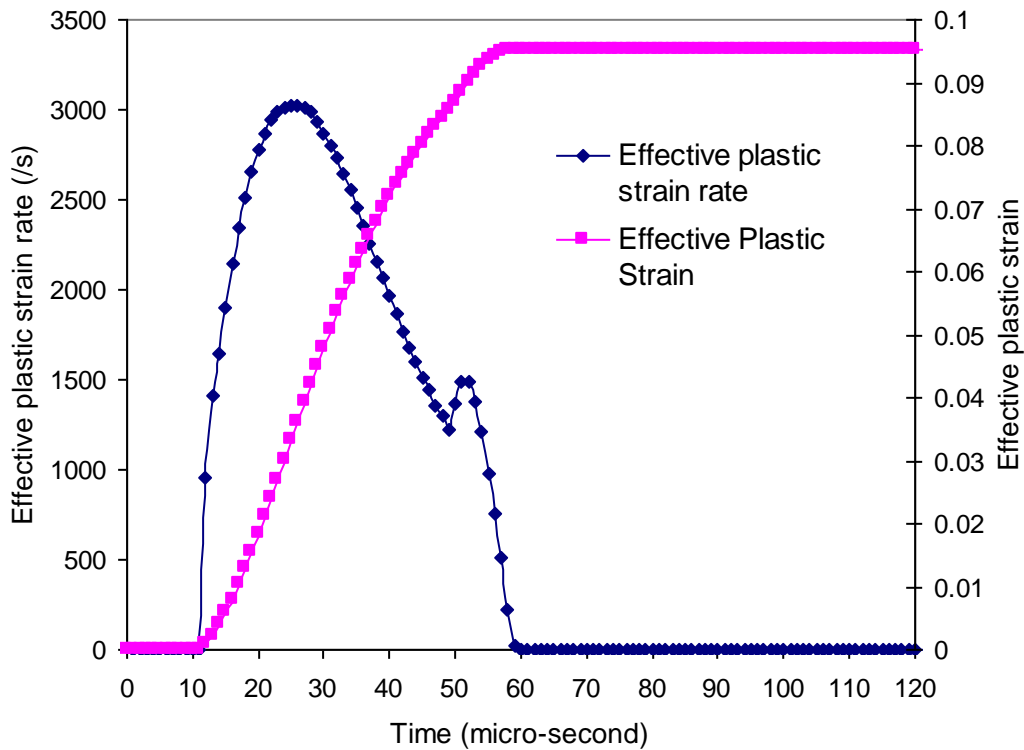

Figure 6. Effective plastic strain and strain rate for 1.2 kJ Al 6061-T6 tube expansion

The values of strain rate sensitivity are relative to the strain rates. Researchers [12, 13] have reported that the strain rate sensitivity increases at strain rates above 1000 s^{-1} for aluminium and aluminium alloys. In this study, the peak strain rate was 3020 s^{-1} and the strain rate sensitivity was small for Al 6061-T6. It is possible that the strain rate sensitivity of Al 6061-T6 will increase if the strain rate is larger than 3020 s^{-1} (such as over $10,000 \text{ s}^{-1}$). More experiments are needed to test this statement.

Although the work in this study verified the low value of the strain rate sensitivity for Al6061-T6, the exact value could not be determined only using EM tube expansion tests and numerical simulation by LS-DYNA EM module. Henchi [7] applied LS-OPT to optimize the parameters of Johnson-Cook strength model by several experiments of same material at different energy levels. This could be the way to determine the constitutive properties without utilizing other experimental techniques.

Effective of meshing

In this study, 2D axisymmetric simulation was used instead of 3D simulation to save computational time. For a spiral coil, there are some simplifications in order to assume 2D axisymmetric case, which may bring in errors. But in this study, 2D axisymmetric simulation results agreed well with the measurement results. Therefore, 2D axisymmetric simulation should be sufficient for the tube expansion with the 3-turn coil in this study.

The different element sizes should have effect on the simulation results. Due to the skin depth of electromagnetic forming, the thinner meshes should show more details in electrical current distributions. To test how thin the meshes should be, different element sizes were applied in the 2D axisymmetric simulation. All the simulations were performed using a computer with two quad-core Intel Xeon processors (3.00 Ghz/1333MHz). And the computer has 16GB of RAM. The simulations were carried out using a single CPU.

Table 2 lists the simulation results with different element sizes. It shows that all the simulation results except Meshing 5 predicted almost the same peak velocity of expansion, which has around 3.4% difference from the measurement results. But Meshing 5 has around 6.0% difference from the measurement results. Considering the large difference of the simulation time, Meshing 2 is more efficient than other cases. Figure 7 also shows the comparison of simulation results with different element sizes.

	Elements of Coil Cross-section	Elements of Tube Cross-section	Simulation time	Predicted Peak Velocity (m/s)
Meshing 1	11x11	7x300	8 hours 7 min.	98.9
Meshing 2	11x11	4x150	1 hour 19 min.	98.8
Meshing 3	22x22	7x300	15 hours 28 min.	98.5
Meshing 4	22x22	4x150	4 hours 53 min.	98.4
Meshing 5	5x5	4x150	45 min.	101.3

Table 2. Comparison of simulation results with different element sizes

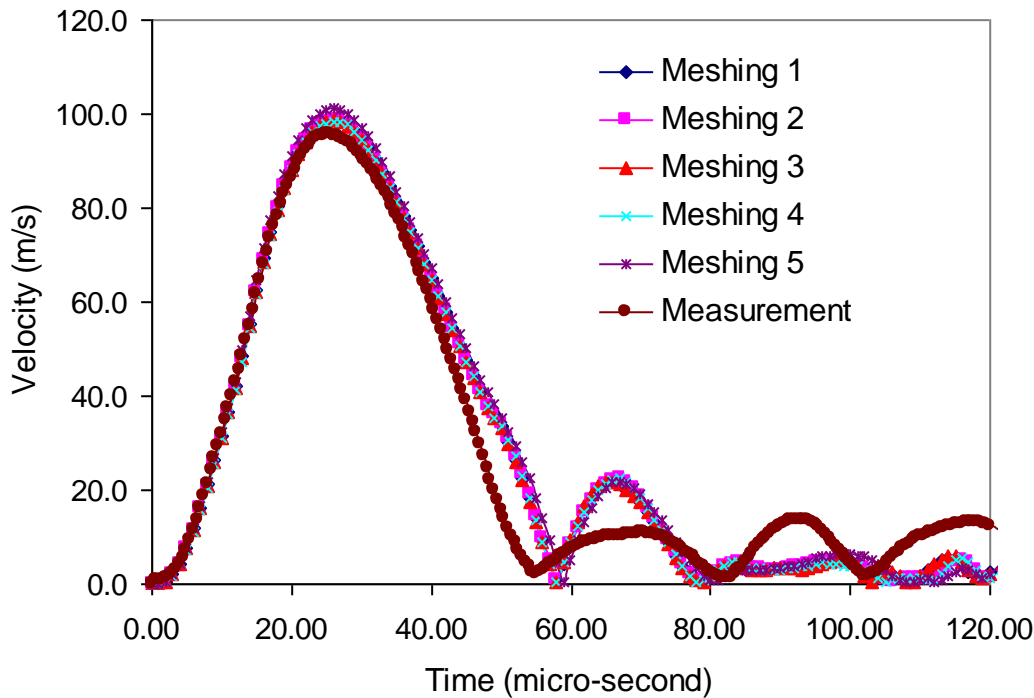

Figure 7. Experimental and numerical simulation results of expansion velocity

Conclusions

Both experiments and numerical simulation of EM Al 6061-T6 tube expansion were performed. The PDV technique provides accurate measurements of expansion velocities and the Rogowski coil provides the current measurement for the simulation input. The comparisons between EM tube expansion simulation and PDV measurements show the excellent capability of LS-DYNA EM module for EM forming simulation. The combination of PDV and EM module simulation can be applied to verify the parameters of constitutive models in high strain rate and is beneficial for the study of the dynamic behavior at high strain rates.

Acknowledgement

The authors would like to thank Professor Glenn Daehn and Mr. Geoffrey Taber of the Ohio State University for the velocity measurement using PDV, and Pierre L'eplattenier of Livermore Software Technology Corporation for LS-DYNA software support.

References

- [1] Field, J.; Walley, S.; Proud, W.; Goldrein, H.; Siviour, C.: *Review of experimental techniques for high rate deformation and shock studies*. International Journal of Impact Engineering 30 (2004), p.725–775.
- [2] Niordson, F. L.: *A Unit for Testing Materials at High Strain Rate*. Experimental Mechanics, 5 (1965), p. 23-32

- [3] Gourdin, W. H.: *Analysis and Assessment of Electromagnetic Ring Expansion as a High-Strain-Rate Test*. Journal of Applied Physics, 65(1989), p. 411-422
- [4] Daehn, S.; Zhang, Y.; Golowin, S., et al.: *Coupling Experiment and Simulation in Electromagnetic Forming Using Photon Doppler Velocimetry*. Proceedings of 4th International Conference on High Speed Forming, Dortmund, Germany, 2008, p. 35-44
- [5] Johnson, J.; Taber, G.; Daehn, G., et al.: *Constitutive relation development through the FIRE test*. Proceedings of 4th International Conference on High Speed Forming, Columbus, OH, 2010, p. 295-306
- [6] L'Eplattenier, P.; Ashcraft, C.; Ulacia, I.: *An MPP version of the Electromagnetism module in LS-DYNA for 3D Coupled Mechanical-Thermal-Electromagnetic simulation*. Proceedings of 4th International Conference on High Speed Forming, Columbus, OH, 2010, p.250-263.
- [7] Henchi, I.; L'Eplattenier, P.; Daehn, G.; Zhang, Y.; Vivek, A.; Stander, N.: *Material constitutive parameter identification using an electromagnetic ring expansion experiment coupled with LS-DYNA and LS-OPT*. Proceedings of 10th international LS-DYNA users conference, Dearborn, 2008, p.14-1~14-10
- [8] Johnson, G.; Cook, W.: *A constitutive model and data for metals subjected to large strains, high strain rates and high temperatures*. Proceedings seventh International Symposium on ballistics, The Hague, The Netherlands, 1983.
- [9] Corbett, B.: *Numerical simulations of target hole diameters for hypervelocity impacts into elevated and room temperature bumpers*. International Journal of Impact Engineering 33 (2006), p. 431-440.
- [10] Elsen, A.; Ludwig, M.; Schaefer, R.; Groche, P.: *Fundamentals of EMPT-Welding*. Proceedings of 4th International Conference on High Speed Forming, Columbus, OH, 2010, p.117-126.
- [11] J.L.Lacome, *Simulation of Hypervelocity Spacecrafts And Orbital Debris Collisions using Smoothed Particle Hydrodynamics in LS-DYNA*, technical report, 2003.
- [12] Holt, D.L.; Babcock, S. G.; Green, S. J.; Maiden, C. J.: *The strain-rate dependence of the flow stress in some aluminium alloys*. Transactions of the ASM: transactions quarterly 60(1967), p.152–159
- [13] Tanaka, K.; Nojima, T.: *Strain rate change tests of aluminium alloys under high strain rate*. Proceedings of the 19th Japan congress on materials research, Tokyo, Japan, 1975, p. 48–51

[14]